

Solid State Contactor – CC1H450 (one phase)

Type: CC1H450

The CC series solid-state contactors are suitable for the contactless and non-wearing switching of ohmic and inductive AC loads at high switching frequency. They come with an operating voltage up to 600 VAC and nominal current up to 50 A with two and three phases. They come with control voltages of either 5–24 VDC or 24–230 VAC/VDC.

Output

Switching element	Thyristor
Numbers of phases	1
Nominal voltage (U_{nom})	400 VAC
Output voltage range	24 – 480 VAC
Reverse voltage	1200 V _{rrm}
Peak reverse voltage	1300 V _{rsm}
Min. load	10 mA
Max. leakage current	1 mA
Operation current AC-1/51 @ U_{nom}	50 A
Operation current AC-3 @ U_{nom}	15 A
Operation current AC-55b @ U_{nom}	20 A
Operation current AC-56a @ U_{nom}	15 A
Response/Release time	20 ms
Limit load	1800 A ² s

Input

Voltage	24 – 230 VAC/VDC
Min. voltage	20,4 VAC/VDC
Max. voltage	253 VAC/VDC
Release voltage	7,2 VAC/VDC
Max. current	6 mA

General Specifications

Ambient temperature storage/operation	-20 – 80°C / -5 – 40°C
Connection terminals	Screw terminal 10 mm ²
Ingress protection degree	IP 20
Mounting	DIN rail TS35
Housing material	PPE Noryl SE1 / Aluminium
Weight	1050 g

Insulation

Insulation voltage	4 kV
Dielectric strength	660 V

Standard type

Starting Torque Limiter

CC1H450



Connection diagram

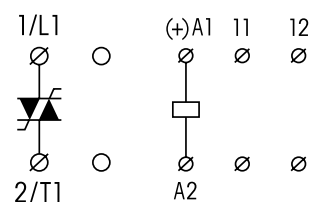

Dimensions [mm]

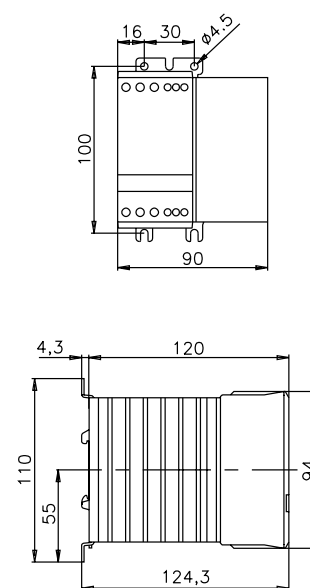

Technical approvals, conformities

