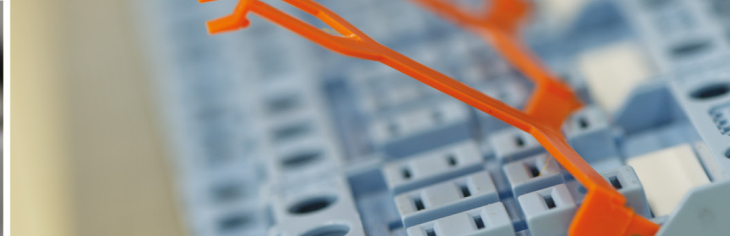
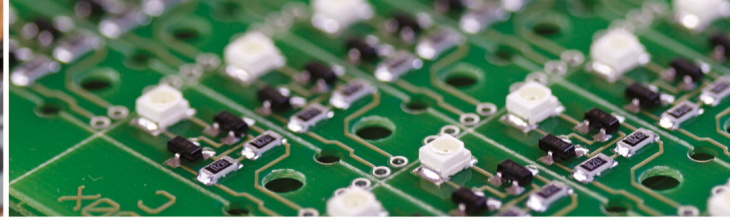
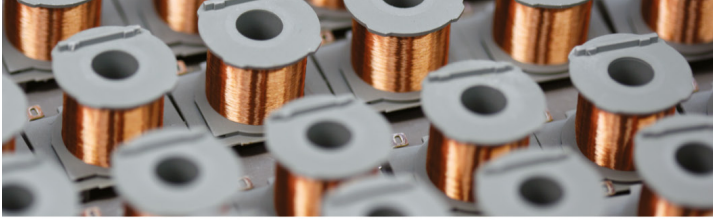


WORLD OF RELAYS

# Catalogue

## WoR 1



## ComatReleco at a glance

ComatReleco is one of the world's leading suppliers of high-quality relays and contactors of all kinds. With one of the broadest product portfolios, including customized solutions, ComatReleco serves customers in the industrial automation and building installation, rail and transportation segments. Our core competencies are industrial relays, timing relays, monitoring relays and contactors. These are installed with the latest semiconductor technologies or also with the traditional electromechanical design.

### **Designed in Switzerland, assembled in...**

ComatReleco continuously invests in research and development, thus ensuring a consistently high rate of innovation. Several international patent applications support this fact. Our research and development team is headquartered in Switzerland and has access to additional qualified employees in our subsidiaries in Germany and China. With a share of more than 20% of total research and development costs, we outperform many global players in our segment.

### **Customer orientation and quality management**

ComatReleco has a group-wide quality management system with real-time access to test and inspection protocols. Our relays and contactors are 100% tested at the end of the production line. On arrival of the goods at our central warehouse in Switzerland, another quality test is carried out.

Are you using a ComatReleco product or are you looking for a suitable solution? Our support centre in Switzerland will be happy to help you find the right relay or contactor for your application. ComatReleco is known for the world's largest number of customized solutions for industrial, time and monitoring relays and contactors.

### **Headquarters in Switzerland – international presence**

The warehouse and logistics are managed centrally at the headquarters in Switzerland. Production is diversified and optimized in terms of quality, costs and logistics criteria. Our production sites are located in Europe and Asia. Through our network of distribution partners, the Group is present on all world markets. ComatReleco has been part of the management team since 2003.

1 Relays & Contactors			Page 7
1.1	Interface Relays - pluggable	C10, C12, C16, C18	15
1.2	Interface Relays	CRINT, CINT, CHA	25
1.3	Industrial Relays - pluggable	C2, C3, C4, C5, C7, R7, C9	33
1.4	Extended Lifetime Relays	C2x, C3x	67
1.5	Solid State Relays	CSS, CRINT	73
1.6	Installation Relays	CHI, C100/200/300, CR, B	81
1.7	Installation Contactors	RIC, RAC, RBC	93
1.8	Industrial Contactors	RMC, RSC	113
1.9	Solid State Contactors	CC1, CC3, CPC	131
2 Time Relays			Page 147
2.1	ON and OFF delay Relays	CMD, AA2, AE2	151
2.2	Multifunction Time Relays	CIM, AL, AM, CM, CPF, CRV, CSV	157
2.3	Star-Delta Relays	CY1	183
2.4	Time Relays - pluggable	C, CS, RS	185
2.5	Timers & Twilight Switches	CPU, QSU, EDS	197
2.6	Time Cubes	CT2, CT3	203
2.7	Time Modules	CT	207
2.8	Timing Relay Accessories	ACESSORIES	213
3 Monitoring & Measuring Devices			Page 223
3.1	Energy Measuring Device	MRE	225
3.2	Multifunction Monitoring	MRM	229
3.3	Voltage Monitoring	MRU, MV, SSU	233
3.4	Voltage Monitoring - pluggable	SSU	239
3.5	Current Monitoring	MRI	243
3.6	Motor Protection - pluggable	TSR	247
3.7	Isolation Monitoring	ESU	249
3.8	Monitoring Modules	CT	251
3.9	Suppressor Device	CEM, CRC	255
3.10	Current Transmitter	MRE-CT	259
3.11	Monitoring Relay Accessories	ACESSORIES	265
4 Sockets			Page 269
4.1	8-Pin Sockets	S2	273
4.2	11-Pin Sockets	EC-11, S3, S5	277
4.3	14-Pin Sockets	S4	287
4.4	8/14-Pin Sockets	S7, S9	291
4.5	5/8-Pin Sockets	S10, S12, S16, S18	297
5 Remote Monitoring & Control			Page 305
5.1	ComatReleco Messaging System (SMS Relay)	CMS	307
5.2	CMS Accessories	ACESSORIES	311
6 Softstarter			Page 325
6.1	Softstarter	CTC, CCL, CCM	327
6.2	DC Motor Controller	CMC, KDM3-24	343

## 1 Relays &amp; Contactors

Type	Page	Type	Page
B103	92	CHI34	83
C2-A2x	36	CINT-51 / CINT-61	29
C3-A3x	37	CINT-52 / CINT-62	30
C3-G3x	39	CINT-53/ CINT-63	31
C3-M1x	40	CPC1230	141
C3-N3x	43	CPC1250	142
C3-R2x	42	CPC1430	143
C3-T3x	38	CPC1450	144
C3-X1x	41	CR11C	89
C4-A4x	44	CR16CX	90
C4-R3x	46	CRINT 1x1 series	27
C4-X2x	45	CRINT 1x2 series	28
C5-A2x	47	CRINT 1x5 series	78
C5-A3x	48	CRINT 1x8 series	79
C5-G3x	49	CRS1C	91
C5-M1x	51	CSS-I	74
C5-M2x	52	CSS-N	76
C5-R2x	53	CSS-P	77
C5-X1x	50	CSS-Z	75
C7-A1x	54	R7-A2x	61
C7-A2x	55	R7-T2x	62
C7-G2x	57	RAC20	101
C7-H2x	58	RAC25	102
C7-T2x	56	RAC40	103
C7-W1x	60	RAC63	104
C7-X1x	59	RBC-AUX	108
C9-A4x	63	RBC-AUX-CM	109
C9-E2x	64	RBC-AUX-GM	110
C9-R2x	65	RBC20	105
C10-A1x	16	RBC32	106
C10-G1x	17	RIC-AUX	107
C10-T1x	18	RIC-DIST	111
C12-A2x	19	RIC-SEAL	112
C12-G2x	20	RIC16	94
C16-A25PTL	21	RIC20	95
C18-A15PT	22	RIC20-xxx-R4A110V	96
C18-A15PTL	23	RIC25	97
C18-B15PTL	24	RIC32	98
C21	68	RIC40	99
C22	69	RIC63	100
C31	70	RMC-AUX	125
C32	71	RMC-DI	129
C133.01	84	RMC-RC	127
C203.01	85	RMC08	114
C203.04	86	RMC11	115
C203.06	87	RSC-AUX	126
C301.04	88	RSC-MBL	130
CC1H215	132	RSC-MP	124
CC1H230	133	RSC-RC	128
CC1H250	134	RSC09	116
CC1H415	135	RSC12	117
CC1H430	136	RSC16	118
CC1H450	137	RSC22	119
CC3H410	138	RSC30	120
CC3H420	139	RSC38	121
CCR3H410	140	RSC43	122
CHA1	32	RSC63	123
CHI14	82		

## 2 Time Relays

Type	Page
AA2, AA2M	154
AE2, AE2M	155
AL1	170
AL3	171
AL4	172
AL5	173
AM1	174
AM2	175
AM3	176
BZS DIN 17.5 mm	215
C55	186
C55.3	187
C55.4	188
C56	189
C64	190
C83	191
C85	192
CIM1, CIM1R	160
CIM2, CIM2R	164
CIM3, CIM3R	167
CIM12, CIM12R	161
CIM13, CIM13R	162
CIM14	163
CIM22, CIM22R	165
CIM23, CIM23R	166
CIM32, CIM32R	168
CIM33, CIM33R	169
CM2	177
CM3	178
CMD11-A	152
CMD11-E	153
CPF11	179
CPU	198
CRV4	180
CS2	193
CS3	194
CSV4	181
CT2	204
CT3	205
CT32R	209
CT33R	210
CT36R	211
CY1	184
EDS17	200
EDS35	201
FA-50	219
FS-C	221
FZ-50L	220
HF-32	216
HF-33	217
HF-50	218
QSU	199
RS 41-M	195
SP-01	214

## 3 Monitoring &amp; Measuring Devices

Type	Page
CEM01	256
CRC02	257
CT515R	252
CT524	253
ESU-D2R	250
FS-23	267
FZ-23	266
HF-24	268
MRE-44S	227
MRE-CT313	260
MRE-CT314	261
MRE-CT614	262
MRE-CT1233	263
MRI11	244
MRI32	245
MRM11, MRM11R	230
MRM32, MRM32R	231
MRU11	234
MRU32	235
MV53	236
SSU31	240
SSU33L	241
SSU34	237
TSR19	248

#### 4 Sockets

Type	Page
EC-11	280
S2-B	274
S2-PO	275
S3-B	278
S3-M	281
S3-M0 / S3-M1	282
S3-S	279
S4-J	288
S4-P	289
S5-M	283
S5-P	284
S5-SSY	285
S7-C	292
S7-IO	293
S7-P	294
S9-M	295
S9-P	296
S10	297
S10-P	299
S12	300
S12-P	301
S16-M	302
S18-M	303

#### 5 Remote Monitoring & Control

Type	Page
CMS-10F	308
CMS-10ADF	309
CMS-10ACDF	310
CMS-ANT-KAB	314
CMS-ANT-MAG/2.5M	313
CMS-ANT-SPEZ/5M	312
CMS-RS232	315
CMS-USB	316
DR-15-24, DR-30-24	317
KS-110	322
MV-LKM-274	318
PS1	323
RF01-U, RF01-U-D2	319
RTBSB-001-010	320
WF50-EXT-U4	321

#### 6 Softstarter

Type	Page
CCL33H415US	330
CCL33H425US	331
CCL33H435US	332
CCM33H425US	337
CCM33H450US	338
CCM33H530USi	339
CCM33H550USi	340
CCM3H403USi	333
CCM3H415	334
CCM3H415DS	335
CCM3H425	336
CCMB3H425	341
CMC1	344
CMC14	345
CMC15	346
CMC16	347
CTC3415	328
CTC3425	329
KDM3-24	348
P82-100C	342

#### 7 Worldwide Sales Network

Country	Page
Argentina	352
Australia	350
Austria	351
Belgium	351
Bolivia	352
Bosnia and Herzegovina	351
Brazil	352
Bulgaria	351
Canada	352
Chile	352
China	350
Colombia	352
Croatia	351
Czech Republic	351
Denmark	351
Ecuador	352
Estonia	351
Finland	351
Germany	351
Great Britain	351
Greece	351
Hungary	351
India	350
Iran	350
Ireland	351
Italy	351
Korea	350
Latvia	351
Lithuania	351
Malaysia	350
Mexico	352
Netherlands	351
New Zealand	350
Nigeria	351
Norway	351
Pakistan	350
Peru	352
Poland	351
Republic of Macedonia	351
Russia	351
Serbia	351
Singapore	350
Slovakia	351
Slovenia	351
Spain	351
Sweden	351
Switzerland	351
Taiwan	350
Thailand	350
Turkey	350
United States	352
Uruguay	352
Vietnam	350



# 1 Relays & Contactors

---

## Industrial Relays

### General Information

#### Product range

ComatReleco offers a wide range of relay types and versions and associated sockets and accessories.

#### Industrial Relays C2, C3, C4, C5

35 x 35 mm round plug-in relay, 8- or 11-terminals multipole connector according to IEC 67 with 2 or 3 contacts up to 10 A and different contact types and contact materials. Standard relay 35 x 35 mm with flat blade connectors with up to 4 contacts and up to 16 A with 4 contacts.

#### Industrial Relays C7, C9

22.5 mm series with up to 4 contacts and up to 10 A with 1 or 2 contacts.

#### Interface Relays, C10, C12, C16, C18

Overall width 13 mm with up to 2 electro-mechanical contacts, or fully electronic switches.

#### Special relays, remanence relays

While "normal" relays are monostable, i.e. they return to the idle state when the excitation is switched off, remanence relays are bistable, i.e. the current switching state is retained irrespective of the excitation. Relays of this type are available in different versions.

#### Solid State Relay CSS

CSS Relays are suitable to either switch AC or DC loads up to 6 A. For AC relays a distinction is made between synchronously (zero crossing) and asynchronously switching versions. For switching transformer loads we recommended using asynchronously switching semiconductor switches. For incandescent lamp loads etc. synchronously switching switches are ideal for avoiding high switch-on currents.

#### Accessories

Suitable sockets are available for the different relay series for DIN rail mounting or panel mounting. In addition, retaining clips are available for the relays, some of which are included in the scope of supply. Suitable bridges for cost-saving wiring in series are also available.

#### (\*) Special requirements

H = Orange button. No lockable function  
N = Black button. No function  
P = PCB pins

E = Lap transparent cover  
T = Close transparent cover (lamp)

PT = PCB pins, 3.5mm grid, transparent cover  
PTL = PCB pins, 5mm grid, transparent cover

### Basic identification principle (type designation code electromechanical relays)

**C** **n(n)** - **T** **X** **y** **z(\*)z** **/...V** **RF-nnnn**

#### Ref. nnnn

Relays with a reference number are versions with special (e.g. customised) features. These features may relate to special test criteria, tolerances or other properties.

Availability of such relays may be limited to certain customers or applications.

#### Nominal coil voltage specification

AC ... V	AC 50/60 Hz,
	voltage 6 – 250 (400) V
AC ... V 60 Hz	AC 60 Hz, 120, 240 V
DC ... V	DC, voltage 5 – 220 V
UC ... V	AC/DC

**X** = Electric position indicating device with LED

#### Describes the options

**D** = Integrated free-wheeling diode  
**F** = Integrated free-wheeling diode and series diode e.g. for common alarm circuits  
**R** = RC connection for the coil  
**B** = Bridge rectifier  
**PT** = Transparent PCB Relay with 3mm Grid  
**PTL** = Transparent PCB Relay with 5mm Grid

#### Definition of contact material

This code may differ depending on type.

Examples:

**0** in the standard range stands for AgNi  
**1–9** see contact material for each type

#### Number of contacts

#### Relay type

**A** = Standard (general-purpose) contact  
**E** = Sensitive drive with 500 mW coil power  
**G** = Refers to a NO contact  
**H** = Single-point contact + twin contact load to signal current circuit for switching state feed back. Mixed contact configuration  
**M** = Relay with highly effective neodymium blow magnet for fast quenching of the arc. This relay is particularly suitable for high DC loads.  
**N** = Sensitive drive 800 mW coil power  
**R** = Code for remanence relays, drive-specific ID  
**S** = Sensitive drive with 250 mW exciter input  
**T** = Twin contact for signal and control circuit  
**W** = With tungsten contact for maximum switch-on currents  
**X** = Relay high power, double make contact.  
**B** = Single C.O. contact with two pins per connection

#### Basic type refers to the product line

Numbers between 2 and 12 and 20, 30 are used.

#### Normal industrial relay code

Relays with code R are used for railway series.



## Coil accessories

### General Information

#### Industrial Relays C2-C9

##### Protection against transients

When the coil is disconnected from an electro-magnet, peaks of inverse voltage appear at the terminals which can reach very high values.

These pulses can be transmitted down the line associated with the coil and could possibly affect other components.

In the case of a relay being operated by such devices as transistors, Triacs, etc; it may be necessary to protect against transients.

##### Transients carried in the line

High voltage surges can be carried in the supply line to the relay coil. These may appear in the form of peaks or bursts and are generated by the connection and disconnection of electric motors, transformers, capacitors etc.

Normally a relay is unaffected by these pulses, but if a diode is connected in association with the coil, it must be capable of withstanding an inverse voltage higher than those of the incoming peaks.

##### Protection circuits

A protection circuit must efficiently cope with pulses generated by the coil as well as incoming line surges (surges  $U_{1.2/50\mu s}$ )

ComatReleco Relays are available with integrated protection circuits or with modules plugged into sockets S3-M, S3-M0 or S3-M1.

**X** LED indication with rectifier.

For DC and AC relays up to 250 V

Note: LED connected, in series with the coil @ 220 V DC in QRC types.

**DX** Free-wheeling diode + LED

Dampens transients caused by the relay coil on de-energisation.

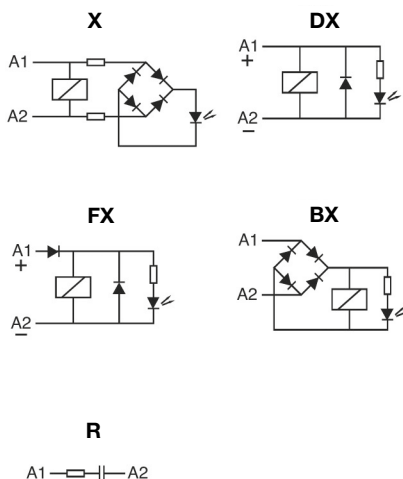
**FX** Polarity + free wheeling diode + LED

A diode in series with the coil protects the relay from reverse connection.

**BX** Bridge rectifier + LED indication

Allows the relay to operate in both AC or DC without any polarity inconvenience. Available only in voltages up to 60 V.

**R** Resistor and capacitor.



#### Industrial Relays C10-C18

**LED and protection circuit connected to coil.**

**X** LED with no polarity, (standard)

Coils  $\leq 12$  V A DC coils

LED rectifier bridge in parallel

**X** LED with no polarity, (standard)

Coils  $\geq 24$  V A DC coils

LED rectifier bridge in series

**FX** LED with polarity **A1+** (option)

Every DC coil voltage

Polarity and Free-wheeling diodes

**BX** LED with no polarity, (option)

Only 24 V and 48 V A DC coils

Rectifier bridge for AC/DC relays

**R** LED not available (option)

RC protection against pulses on AC

##### Protection against pulses

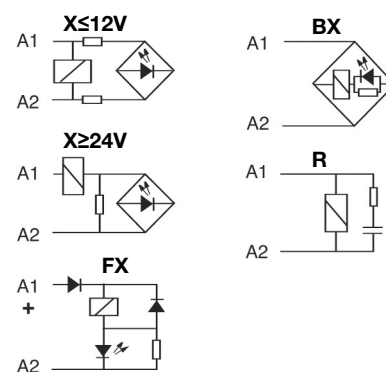
When a relay coil is disconnected, reverse voltage peaks may arise and reach very high values. Said peaks can transmit to the coil associated line and other relays or semiconductors can be affected.

If Triac, transistor, etc. controls a relay, appropriate steps must be taken to avoid or decrease peaks down to a non risky level.

Both Polarity and Free-wheeling diodes (**FX**), must protect coils, to avoid malfunctions provided DC relays in battery are installed.

Making or breaking engines, transformers or contactors in an industrial environmental, may generate high voltage pulses, either isolated or burst, through the main line.

The voltage level of those pulse may be high enough to affect the isolation of the coil.



## Contacts

There are different contact types. The main distinction is between single contacts and twin contacts. While single contacts are more suitable for higher loads, twin contacts are significantly more reliable at small loads, i.e. < 24V, < 100mA.

### Contact Material

There is no all-purpose contact!

AgNi is used as standard material for a wide range of applications. AgNi contacts with hard gold plating (up to 5µm) are offered for applications in aggressive atmosphere.

Relays with gold contacts are approved for relatively high currents (e.g. 6A, 250V), but in practice values of 200mA, 30V should not be exceeded for operation with intact gold plating.

Relays with a tungsten pre-contact are available for very high switch-on currents (up to 500A, 2.5ms). For some applications AgNi contacts with gold flashing (0.2µm) are available. The purpose is corrosion protection during storage. Tin oxide is specially appropriated for load with high-inrush current.

### Minimum load

The minimum load value is a recommended value under normal conditions such as regular switching, no special ambient conditions, etc. Under these conditions reliable switching behaviour can be expected.

### Contact resistance

Initial values of resistance of contact can vary with the use, load and others conditions. Typical values when the relay is new is about 50mΩ.

### Contact spacing

Normally all contacts have an air gap between 0.5 ... 1.5mm when they are open. They are referred to as µ contacts. According to the Low-Voltage Directive and the associated standards these contacts are not suitable for safe disconnection.

For switching of DC loads large contact clearances are beneficial for quenching the arc. See relays with "Cx-Gyz" naming. "G" stands for extended contact gap of 3mm.

### Switching capacity

The contact switching capacity is the product of switching voltage and switching current. For AC the permitted switching capacity is generally high enough to handle the max. continuous AC-1 current over the whole voltage range. For DC the load limit curve must never be exceeded, because this would lead to a remaining switch-off arc and immediate destruction of the relay. The order of magnitude of the DC switching capacity is a few 100W (DC-1).

## Drive (coil)

The drive of a relay refers to the coil plus connections.

The coil has special characteristics, depending on the rated voltage and the type of current.

### Coil design

The coil consists of a plastic former (resistant up to about 130°C) and doubly insulated high-purity copper wire, temperature class F. The winding must withstand threshold voltages (EN 61000-4-5) of more than 2000V. This is ensured through forced separation of the start and end of the winding.

### Coil resistance and other properties

Each coil has an ohmic resistance that can be verified with an ohmmeter. The specified coil resistance applies to a temperature of 20°C. The tolerance is ±10%.

For AC operation the coil current will not match the ohmic value, because self-inductance plays a dominant role. At 230V this may reach more than 90H. When a relay is switched off, self-inductance results in a self-induced voltage that may affect the switching source (destruction of transistors, EMC problems).

### Drive voltages

A distinction is made between the standardised voltages according to EN 60947 as guaranteed values, and typical values that can be expected with a high degree of probability.

### Pick-up voltage, Release voltage

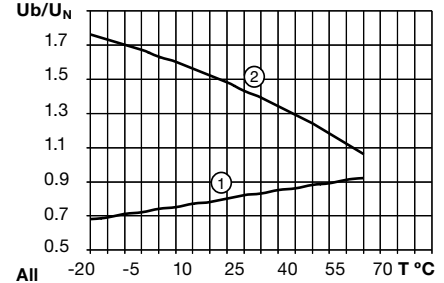
The pick-up voltage is the voltage at which the relay engages safely. For DC the typical trip voltage is approx. 65% of  $U_{nom}$ , for AC approx. 75%. The release voltage, on the other hand, is approx. 25% or 60% respectively. For DC these voltages are strongly temperature-dependent, according to the temperature coefficient of Cu. This is not the case for AC, where the inductive resistance is the controlling factor, which is practically constant over a wide temperature range.

With AC, in a certain undervoltage range the relay may hum, and the armature may flutter. This voltage range must be avoided.

### Operating voltage range

Unless specified otherwise, the following characteristic curve applies for the operating voltage range. The upper limit of the coil voltage is determined by self-heating and the ambient temperature. Self-heating through contacts under high load must not be underestimated. It may be higher than the power dissipation in the drive.

During intermittent operation significantly higher overvoltages temporary may occur for short periods. If in doubt please consult our specialists.



## General design

ComatReleco Relays are made from high-quality, carefully selected materials.

They comply with the latest environmental regulations such as RohS. Their meticulous design makes them particularly suitable for industrial applications and installation engineering.

They are particularly service-friendly through robust terminals, mechanical position indicating device a standard, manual operation, dynamic, permanent characteristics. Colour coding for manual operation as a function of the coil voltage is another useful feature. Further options such as different coil connections, free-wheeling diode, LED display, bridge rectifier for AC/DC drives etc., and short-term availability of special versions for practically any drive voltage up to DC 220V / AC 400V leave nothing to be desired. Apart from a few special versions, in general, ComatReleco industrial relays feature manual operation (push/pull) and a mechanical position indicating device.

For safety reasons, manual operation may be replaced with a black button, if required.

### Coil connections

Different coil connections can be integrated in the relay as an option.

For DC a cost-effective free-wheeling diode is available. Please note that the stated release times are generally specified without the coil connection.

While an additional LED status indicator has practically no effect, a free-wheeling diode (D) will lead to an increase in release time by a factor 2 to 5, or 10ms to 30ms. For AC VDRs or RC elements may be used. In this case resonance effects may have to be considered. VDRs and common RC elements may increase release times by less than 5 ms.

## Industrial Relays

### General Information

#### Standards, conformities

All ComatReleco relays feature the CE mark to indicate that CE standards apply e.g. 2kV surge resistance according to EN 61000-4-5. A significant and not generally available characteristic is that the coils and in particular the connections are able to withstand the voltage spikes that may occur in practice. In addition, the relays feature various technical approvals depending on the respective relay code, and they comply with further standards and guidelines. The main technical approvals include cURus, CCC, Lloyd's Register, cULus and EAC. The associated information is provided in the data sheets.

#### Switching classes

EN 60947 defines different switching classes that specify the suitability of contacts for different load types.

#### Example:

AC-1 = Ohmic AC load

AC-3 = Motor loads

AC-15 = Power contactors, solenoid valves, solenoids

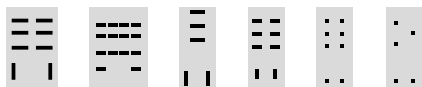
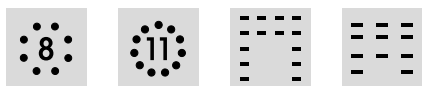
DC-1 = Ohmic DC load

DC-13 = DC contactors, solenoids





UL60947 contains different technical approval criteria such as general purpose, control application etc. Switching classes are defined based on the electrical switching capacity, e.g. B600 etc.

#### Choosing the right Socket

For plug-in industry, interface, time, and monitoring relays, we offer sockets with the corresponding pin configuration and various layouts for the terminal connectors. For easy identification, you'll find those symbol referring to the matching socket.



#### Main technical approvals and standards

Country	Technical approval
China	 Authority: CQC Specification GB14048.5-2001
Russia	 Authority: KORPORATSIA STANDART Specification TP TC 004/2011
World Wide USA / Canada	 Authority: UL Specification C 22.2; UL 60947
United Kingdom	 Authority: GB Lloyd's Register of Shipping

#### Utilisation categories according to EN 60947-4-1/-5-1

#### Pollution category

##### Cat. 1

Dry, non-conductive contamination without further effect

##### Cat. 2

Occasional conductive contamination, short duration due to moisture condensation

##### Cat. 3

Dry, non-conductive and conductive contamination with moisture condensation

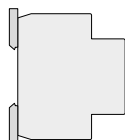
##### Cat. 4

Contamination with persistent conductivity through conductive dust, rain

**Protection class IP** according to EN 60529 and other standards. Industrial relays and their sockets can be classified as follows: Socket IP20: Contact safety Relay IP40/IP50: not watertight, but protected against ingress of coarse contaminants.

#### Electrical Distributor DIN 45mm

All devices with a housing fitting in an electrical distributor with a front of 45mm are marked with the following symbol.



#### Further information and tips

The main operational criteria for relays such as number of cycles, switching frequency, ambient conditions, reliability requirements, load type, switch-on current, load switch-off energy must be clarified in order to ensure reliable operation and long service life.

#### Example

If the number of cycles is expected to exceed several 100.000 operations per year (e.g. clock generators, fast running machines), an electronic solution is no doubt more appropriate, although we also offer solutions for this type of application. In AC applications crosstalk caused by long control leads is often a problem and can result in constant humming of the relay or even inadvertent triggering due to interference.

Different harmless loads may lead to very high switch-on currents or switch-off energy values, resulting in an unacceptable reduction in service life.

Particularly tricky are DC inductive loads.

#### Characteristics of various loads:

##### Heating circuits

No higher switch-on currents, no higher switch-off loads.

##### Incandescent lamps, halogen lamps

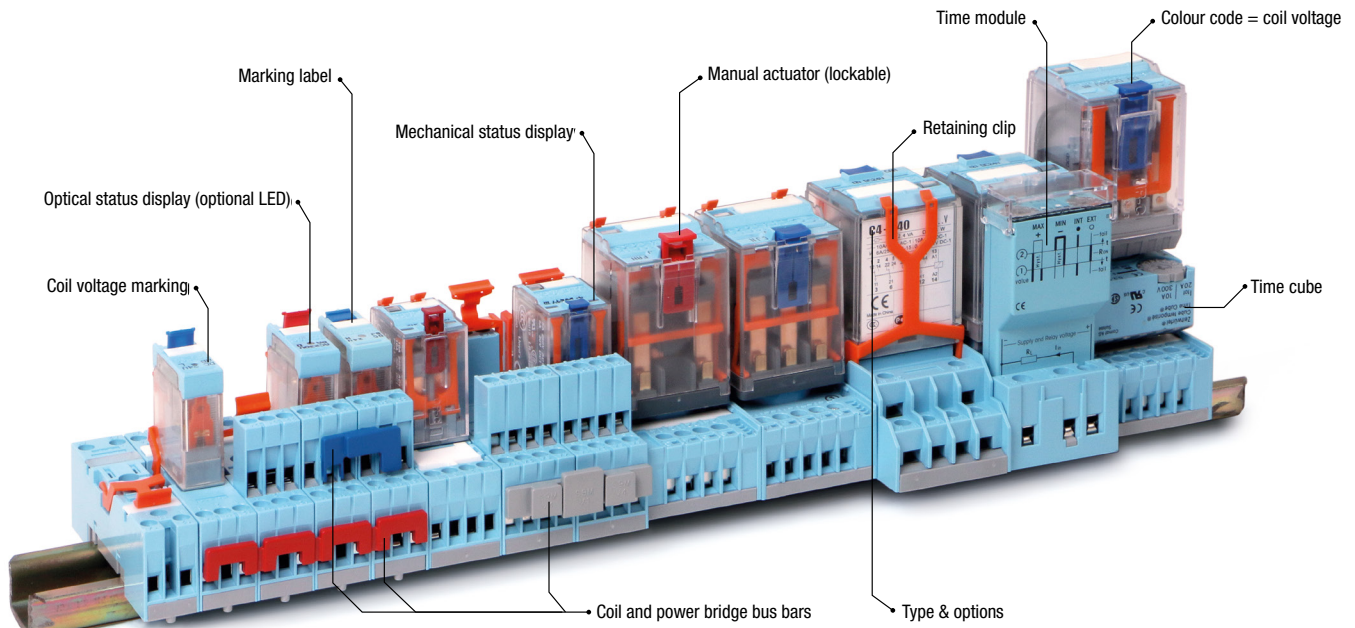
Switch-on currents during a few ms in the range 10 ... 18 x rated. Switch-off at rated load.

##### Low-energy lamps

Very high, but very short switch-on currents due to built-in decoupling capacitors. Contacts have a tendency to fuse.

##### Transformers, AC contactors

Switching on during zero-transition may lead to switch-on currents of 8 ... 15 x rated. High inductive switch-off energy is possible. The load must be connected, not least due to EMC problems.





- X** LED
- DX** Freewheeling diode, LED
- BX** Bridge rectifier, LED
- FX** Polarity protection, freewheeling diode, LED

**Five colours for an easier identification of coil voltage**

-  **AC** red: 230 V AC (North America 120 V AC)
-  **AC** dark red: others V AC
-  **UC** grey: V AC/DC
-  **DC** blue: 24 V DC
-  **DC** dark blue: others V DC

If you don't want to have the lockable function, you can use the orange button.

-  Orange button, no lockable function, push only
-  Black button, no function

**Comprehensive technical label**

**C3-X10** — Part number

AC 2.8 VA DC 1.3 W — Coil details

10A/250V AC-1 | 10A/30V DC-1 — Maximum switching capacity according to EN 60947 (IEC 947)





3 9 2 A1 A2 10 — Additional circuit diagram for coil Electric diagram showing all additions to the coil

CE, UL US, 10A 250 Vac, 10A 30 Vdc, Made in India — Approvals

Wiring diagram with sequential and DIN numbers










• Level of switching current and voltage of the application?

• DC or AC switching?  
 • Inductive or capacitive load?  
 • Expected number of switching cycles?

Symbol	Voltage	Current	Use	Type	Material
 Signal relays	100 mV...5V	10 uA...1 mA	Low-level signals, Standard signals (0...10V/ 4...20mA)	Gold-plated double contact	AgNi + Ag
				Gold-plated Single Contact	AgNi + Ag
 Control relays	5V...30V	1 mA...100 mA	PLC inputs, Control circuits	double contact	AgNi
				Gold-plated Single Contact	AgNi + Ag
			Frequent, rapid switching procedures	Semiconductor	Mosfet (DC) Triac (AC)
 Power relays	30V...400V	100 mA...16A	Increased AC or DC loads	Single Contact	AgNi
			Electromagnets (utilisation cat. AC-15/DC-13)	Single Contact	AgSnO <sub>2</sub>
			Frequent, rapid switching procedures, high reliability, noiseless switching	Semiconductor	Mosfet (DC) Triac (AC)
 High-power relays	12V...400V	100 mA...16A	Capacitive loads	Early make contact	AgNi + W AgSnO <sub>2</sub> + W
			High DC loads, inductive loads	Series contacts	AgNi AgSnO <sub>2</sub>
			Frequent, rapid switching procedures, high reliability, noiseless switching	Semiconductor	Mosfet (DC) Triac (AC)



## 1.1 Interface Relays - pluggable

Application	Type	Pin	Page
<b>C10 Series</b>			
1 pole   changeover contact   Faston	C10-A1x		16
1 pole   normally open contact   Faston	C10-G1x		17
1 pole   changeover twin contact   Faston	C10-T1x		18
<b>C12 Series</b>			
2 pole   changeover contact   Faston	C12-A2x		19
2 pole   normally open contact   Faston	C12-G2x		20
<b>C16 Series</b>			
2 pole   8-pin   changeover contact   Grid 5mm	C16-A25PTL		21
<b>C18 Series</b>			
1 pole   5-pin   changeover contact   Grid 3.5mm	C18-A15PT		22
1 pole   5-pin   changeover contact   Grid 5mm	C18-A15PTL		23
1 pole   8-pin   changeover contact   Grid 5mm	C18-B15PTL		24

# C10-A1x

1 pole | changeover contact | Faston

<b>Maximum contact load</b>	10 A/250 V AC-1	0.5 A/110 V DC-1
	10 A/30 V DC-1	0.2 A/220 V DC-1
<b>Recommended minimum contact load</b>	10 mA/10 V Code 0, 5	
	5 mA/5 V Code 8	

### Contacts

Material	Standard	Code 0	AgNi
	Optional	Code 8	AgNi + 5 μ Au
	Optional	Code 5	AgSnO <sub>2</sub>
Rated Load	10 A		
Max. inrush current (20 ms)	30 A (120 A for code 5)		
Switching voltage max.	250 V		
AC load fig. 1	2.5 kVA		
DC load	see fig. 2		

### Coil

Coil resistance	see table; tolerance ± 10 %
Pick-up voltage	≤ 0.8 × U <sub>n</sub>
Release voltage	≥ 0.1 × U <sub>n</sub>
Nominal power	1.1 VA (AC)/0.7 W (DC)

### Coil table

V AC	Ω	mA	V DC	Ω	mA
24	290	45	12	224	53
48	1200	23	24	742	32
115	7.300	9.5	48	3.500	13.7
230	28.800	4.7	110	19.900	5.5

### Insulation

Contact open	1000 V
Contact/coil	5 kV
Insulation resistance at 500 V	≥ 1 GΩ
Insulation, IEC 61810-1	4 kV

### Specifications

Ambient temperature operation/storage	-40 ... 70 °C / -40 ... 80 °C (no ice)
Pick-up time/bounce time	10 ms / ≤ 1 ms
Release time/bounce time	5 ms / ≤ 3 ms
Mechanical life ops	AC: 10 Mill./DC: 20 Mill.
DC voltage endurance at rated load	≥ 100 000 switching cycles
Max. switching frequency at rated load	1200/h
Weight	21g

### Product References

<b>V AC 50 Hz/60 Hz: 24, 48, 115 (120), 230 (240)</b>	<b>C10-A10/AC...V</b>	<b>C10-A18/AC...V</b>	<b>C10-A15/AC...V</b>
<b>LED</b>	<b>C10-A10X/AC...V</b>	<b>C10-A18X/AC...V</b>	<b>C10-A15X/AC...V</b>
<b>RC Suppressor</b>	<b>C10-A10R/AC...V</b>	<b>C10-A18R/AC...V</b>	<b>C10-A15R/AC...V</b>
<b>V DC 12, 24, 48, 110</b>	<b>C10-A10/DC...V</b>	<b>C10-A18/DC...V</b>	<b>C10-A15/DC...V</b>
<b>LED</b>	<b>C10-A10X/DC...V</b>	<b>C10-A18X/DC...V</b>	<b>C10-A15X/DC...V</b>
<b>Polarity and free wheeling diode</b>	<b>C10-A10FX/DC...V</b>	<b>C10-A18FX/DC...V</b>	<b>C10-A15FX/DC...V</b>
<b>V AC/DC bridge rectifier 24 V, 48 V</b>	<b>C10-A10BX/UC...V</b>	<b>C10-A18BX/UC...V</b>	<b>C10-A15BX/UC...V</b>

Other voltages on request

"..." List Coil Voltage to complete Product References

### Accessories

Socket	<b>S10, S10-P</b>
--------	-------------------



### Connection diagram

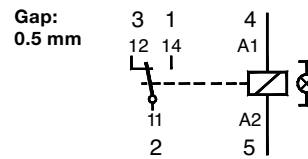


fig. 1 AC voltage endurance

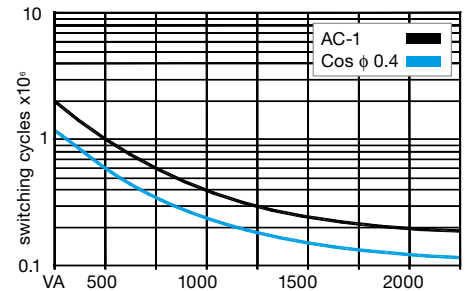
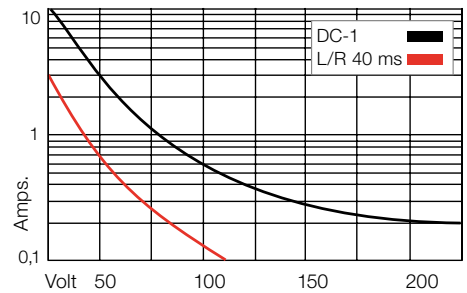
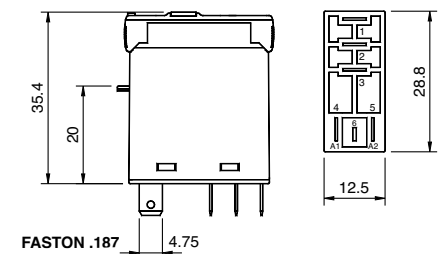


fig. 2 DC load limit curve



### Dimensions (mm)



### Technical approvals, conformities



IEC/EN 61810; IEC/EN 60947



# C10-G1x

1 pole | normally open contact | Faston

<b>Maximum contact load</b>	10 A/250 V AC-1	0.8 A/110 V DC-1
	10 A/30 V DC-1	0.4 A/220 V DC-1
<b>Recommended minimum contact load</b>	10 mA/10 V Code 0, 5	
	5 mA/5 V Code 8	

### Contacts

Material	Standard	Code 0	⚡ AgNi
	Optional	Code 5	⚡ AgSnO <sub>2</sub>
Rated Load	10 A		
Max. inrush current (20 ms)	30 A (120 A for code 5)		
Switching voltage max.	250 V		
AC load fig. 1	2.5 kVA		
DC load	see fig. 2		

### Coil

Coil resistance	see table; tolerance ± 10 %
Pick-up voltage	≤ 0.8 × U <sub>n</sub>
Release voltage	≥ 0.1 × U <sub>n</sub>
Nominal power	1.1 VA (AC)/0.7 W (DC)

### Coil table

V AC	Ω	mA	V DC	Ω	mA
24	290	45	12	224	53
48	1200	23	24	742	32
115	7.300	9.5	48	3.500	13.7
230	28.800	4.7	110	19.900	5.5

### Insulation

Contact open	2000 V
Contact/coil	5 kV
Insulation resistance at 500 V	≥ 1 GΩ
Insulation, IEC 61810-1	4 kV

### Specifications

Ambient temperature operation/storage	-40 ... 70 °C / -40 ... 80 °C (no ice)
Pick-up time/bounce time	10 ms / ≤ 1 ms
Release time/bounce time	8 ms
Mechanical life ops	AC: 10 Mill./DC: 20 Mill.
DC voltage endurance at rated load	≥ 100 000 switching cycles
Max. switching frequency at rated load	1200/h
Weight	21g

### Product References

V AC 50 Hz/60 Hz: 24, 48, 115 (120), 230 (240)

LED

RC Suppressor

V DC 12, 24, 48, 110

LED

Polarity and free wheeling diode

AC/DC bridge rectifier 24 V, 48 V

Other voltages on request

C10-G10/AC ... V  
C10-G10X/AC ... V  
C10-G10R/AC...V

C10-G10/DC ... V  
C10-G10X/DC ... V  
C10-G10FX/DC ... V

C10-G10BX/DC ... V

C10-G15/AC ... V  
C10-G15X/AC ... V  
C10-G15R/AC...V

C10-G15/DC ... V  
C10-G15X/DC ... V  
C10-G15FX/DC... V

C10-G15BX/UC... V

"..." List Coil Voltage to complete Product References

### Accessories

Socket **S10, S10-P**



### Connection diagram

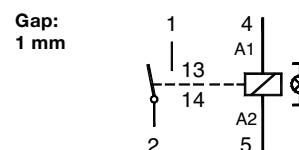


fig. 1 AC voltage endurance

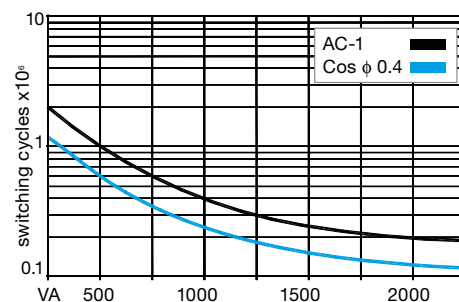
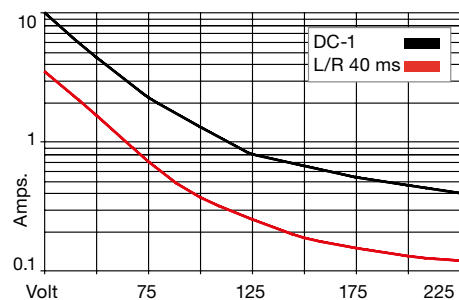
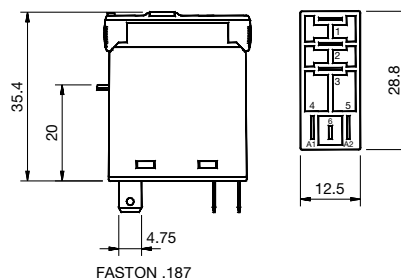


fig. 2 DC load limit curve



### Dimensions (mm)



### Technical approvals, conformities



# C10-T1x

1 pole | changeover twin contact | Faston

<b>Maximum contact load</b>	<b>6 A/250 V</b>	<b>AC-1</b>	<b>0.5 A/110 V</b>	<b>DC-1</b>
	<b>6 A/30 V</b>	<b>DC-1</b>	<b>0.2 A/220 V</b>	<b>DC-1</b>
<b>Recommended minimum contact load</b>	<b>5 mA/5 V</b>	<b>Code 1</b>		
	<b>1 mA/5 V</b>	<b>Code 3</b>		

### Contacts

Material	Standard	Code 1	AgNi + 0.2 μ Au
	Optional	Code 3	AgNi + 5 μ Au
Rated Load			6 A
Max. inrush current (20 ms)			15 A
Switching voltage max			250 V
AC load fig. 1			1.5 kVA
DC load			see fig. 2

### Coil

Coil resistance	see table; tolerance ± 10 %
Pick-up voltage	≤ 0.8 × U <sub>N</sub>
Release voltage	≥ 0.1 × U <sub>N</sub>
Nominal power	1.1 VA (AC)/0.7 W (DC)

### Coil table

V AC	Ω	mA	V DC	Ω	mA
24	290	45	12	224	53
48	1200	23	24	742	32
115	7.300	9.5	48	3.500	13.7
230	28.800	4.7	110	19.900	5.5

### Insulation

Contact open	1000 V
Contact/coil	5 kV
Insulation resistance at 500 V	≥ 1 GΩ
Insulation, IEC 61810-1	4 kV

### Specifications

Ambient temperature operation/storage	-40 ... 70 °C / -40 ... 80 °C (no ice)
Pick-up time/bounce time	10 ms / ≤ 1 ms
Release time/bounce time	5 ms / ≤ 3 ms
Mechanical life ops	AC: 10 Mill./DC: 20 Mill.
DC voltage endurance at rated load	≥ 100 000 switching cycles
Max. switching frequency at rated load	1200/h
Weight	21 g

### Product References

V AC 50 Hz/60 Hz: 24, 48, 115 (120), 230 (240)

LED

RC Suppressor

V DC12, 24, 48, 110

LED

Polarity and free wheeling diode

AC/DC bridge rectifier 24 V, 48 V

Other voltages on request

C10-T11/AC ... V  
C10-T11X/AC ... V  
C10-T11R/AC...V

C10-T13/AC ... V  
C10-T13X/AC ... V  
C10-T13R/AC...V

C10-T11/DC ... V  
C10-T11X/DC ... V  
C10-T11FX/DC ... V

C10-T13/DC ... V  
C10-T13X/DC ... V  
C10-T13FX/DC ... V

C10-T11BX/UC ... V

C10-T13BX/UC ... V

"..." List Coil Voltage to complete Product References

### Accessories

Socket **S10, S10-P**



### Connection diagram

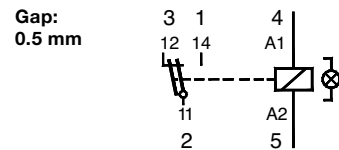


fig. 1 AC voltage endurance

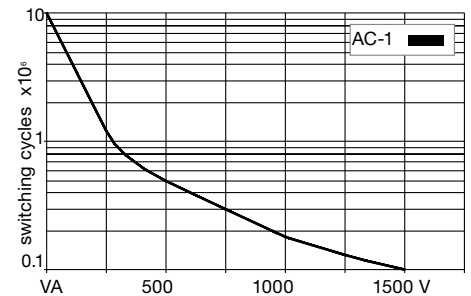
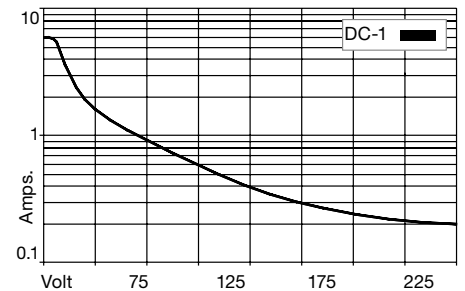
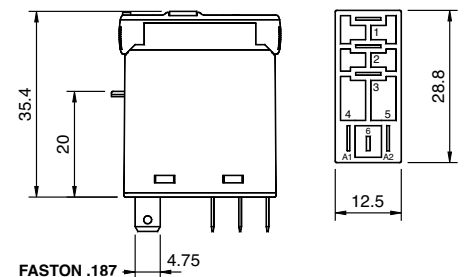


fig. 2 DC load limit curve



### Dimensions (mm)



### Technical approvals, conformities



IEC/EN 61810; IEC/EN 60947

## 1.1 Interface Relays - pluggable

**C12-A2x**
**2 pole | changeover contact | Faston**

<b>Maximum contact load</b>	<b>5 A/250 V AC-1</b>	<b>0.5 A/110 V DC-1</b>
	<b>5 A/30 V DC-1</b>	<b>0.2 A/220 V DC-1</b>
<b>Recommended minimum contact load</b>	<b>10 mA/10 V Code 1</b>	
	<b>5 mA/5 V Code 2</b>	

**Contacts**

Material	Standard	Code 1	AgNi + 0.2 μ Au
	Optional	Code 2	AgNi + 5 μ Au
Rated Load	5 A		
Max. inrush current (20 ms)	15 A		
Switching voltage max.	250 V		
AC load fig. 1	1.2 kVA		
DC load	see fig. 2		

**Coil**

Coil resistance	see table; tolerance ± 10 %
Pick-up voltage	≤ 0.8 × U <sub>n</sub>
Release voltage	≥ 0.1 × U <sub>n</sub>
Nominal power	1.1 VA (AC)/0.7 W (DC)

**Coil table**

V AC	Ω	mA	V DC	Ω	mA
24	290	45	12	224	53
48	1200	23	24	742	32
115	7.300	9.5	48	3.500	13.7
230	28.800	4.7	110	19.900	5.5

**Insulation**

Contact open	1000 V
Contact/contact	3000 V
Contact/coil	5 kV
Insulation resistance at 500 V	≥ 1 G.Ω
Insulation, IEC 61810-1	4 kV

**Specifications**

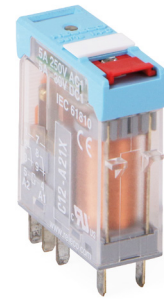
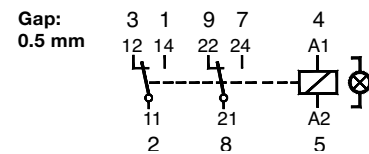
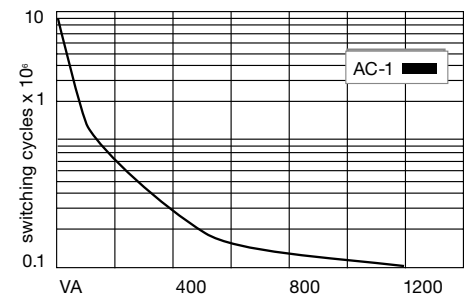
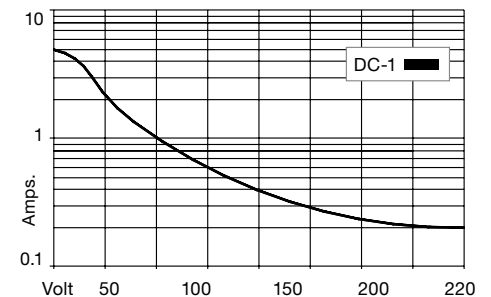
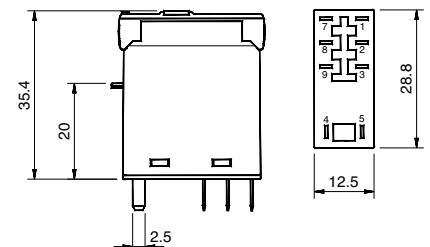
Ambient temperature operation/storage	-40 ... 60 °C / -40 ... 80 °C (no ice)
Pick-up time/bounce time	10 ms / ≤ 1 ms
Release time/bounce time	5 ms / ≤ 3 ms
Mechanical life ops	AC: 10 Mill./DC: 20 Mill.
DC voltage endurance at rated load	≥ 100 000 switching cycles
Max. switching frequency at rated load	1200/h
Weight	21 g

**Product References**
**V AC 50 Hz/60 Hz: 24, 48, 115 (120), 230 (240)**
**LED**
**RC Suppressor**
**V DC 12, 24, 48, 110**
**LED**
**Polarity and free wheeling diode**
**AC/DC bridge rectifier 24 V, 48 V**

Other voltages on request

"... " List Coil Voltage to complete Product References

**Accessories**

 Socket **S12, S12-P**

**Connection diagram**

**fig. 1 AC voltage endurance**

**fig. 2 DC load limit curve**

**Dimensions (mm)**


FASTON .098

**Technical approvals, conformities**


IEC/EN 61810; IEC/EN 60947

# C12-G2x

2 pole | normally open contact | Faston

<b>Maximum contact load</b>	<b>5 A/250 V AC-1</b>	<b>0.8 A/110 V DC-1</b>
	<b>5 A/30 V DC-1</b>	<b>0.4 A/220 V DC-1</b>
<b>Recommended minimum contact load</b>	<b>10 mA/10 V Code 1</b>	
	<b>5 mA/5 V Code 2</b>	

### Contacts

Material	Standard	Code 1	AgNi + 0.2 μ Au
	Optional	Code 2	AgNi + 5 μ Au
Rated Load	5 A		
Max. inrush current (20 ms)	15 A		
Switching voltage max.	250 V		
AC load fig. 1	1.2 kVA		
DC load	see fig. 2		

### Coil

Coil resistance	see table; tolerance ± 10 %
Pick-up voltage	≥ 0.8 × U <sub>N</sub>
Release voltage	≥ 0.1 × U <sub>N</sub>
Nominal power	1.1 VA (AC)/0.7 W (DC)

### Coil table

V AC	Ω	mA	V DC	Ω	mA
24	290	45	12	224	53
48	1200	23	24	742	32
115	7.300	9.5	48	3.500	13.7
230	28.800	4.7	110	19.900	5.5

### Insulation

Contact open	2000 V
Contact/contact	3000 V
Contact/coil	5 kV
Insulation resistance at 500 V	≥ 1 GΩ
Insulation, IEC 61810-1	4 kV

### Specifications

Ambient temperature operation/storage	-40 ... 60 °C / -40 ... 80 °C (no ice)
Pick-up time/bounce time	10 ms / ≤ 1 ms
Release time/bounce time	5 ms / ≤ 3 ms
Mechanical life ops	AC: 10 Mill./DC: 20 Mill.
DC voltage endurance at rated load	≥ 100 000 switching cycles
Max. switching frequency at rated load	1200/h
Weight	21 g

### Product References

V AC 50 Hz/60 Hz: 24, 48, 115, (120), 230, (240)

LED

RC Suppressor

C12-G21/AC ... V

C12-G21X/AC ... V

C12-G21R/AC ... V

C12-G22/AC ... V

C12-G22X/AC ... V

C12-G22R/AC ... V

V DC 12, 24, 48, 110

LED

Polarity and free wheeling diode

C12-G21/DC ... V

C12G21X/DC ... V

C12-G21FX/DC ... V

C12-G22/DC ... V

C12-G22X/DC ... V

C12-G22FX/DC ... V

AC/DC bridge rectifier 24 V, 48 V

Other voltages on request

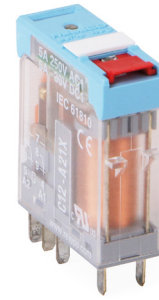
C12-G21BX/UC ... V

C12-G22BX/UC ... V

"..." List Coil Voltage to complete Product References

### Accessories

Socket **S12, S12-P**



### Connection diagram

Gap: 1 mm

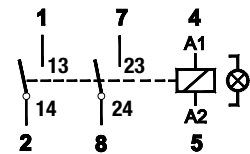


fig. 1 AC voltage endurance

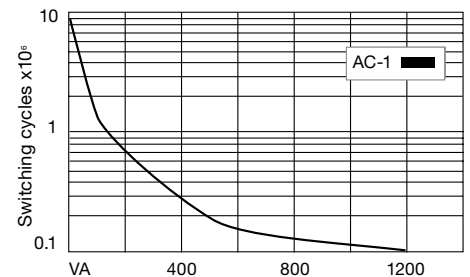
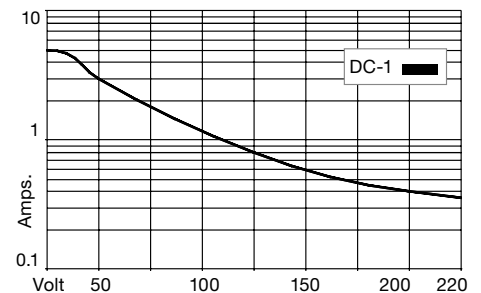
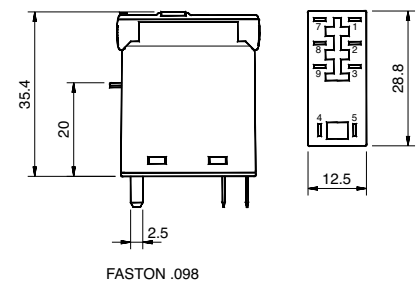


fig. 2 DC load limit curve



### Dimensions (mm)



### Technical approvals, conformities



IEC/EN 61810; IEC/EN 60947

**C16-A25PTL****2 pole | 8-pin | changeover contact | Grid 5mm**

<b>Maximum contact load</b>	<b>7 A/250V AC-1</b>
	<b>7 A/30V DC-1</b>
<b>Recommended minimum contact load</b>	<b>1 mA/1V AC/DC</b>

**Contacts**

Material	⚡ AgSnO <sub>2</sub>
Rated Load	7 A
Switching voltage max.	250V
Max. inrush current (500 ms)	15 A
Bounce time	2 ms

**Coil**

Coil resistance	see table; tolerance $\pm 10\%$
Pick-up voltage	75% of U <sub>N</sub> (DC) / 80% of U <sub>N</sub> (AC)
Release voltage	$\leq 0.1 U_N$ (DC) / $\leq 0.3 U_N$ (AC)
Nominal power	1 VA (AC) / 0.53 W (DC) @ 23 °C

**Coil Data (DC voltage)**

Coil Voltage Code	Nominal Voltage (V DC)	Coil Resistance ( $\Omega$ ) $\pm 10\%$	Must operate voltage max. (VDC)	Must release voltage min (VDC)
12	12	270	9.00	1.2
24	24	1080	18.00	2.4
36	36	1350	27.00	3.6
48	48	4340	36.00	4.8
110	110	22830	82.5	11

**Coil Data (AC voltage 50/60Hz)**

Coil Voltage Code	Nominal Voltage (V AC)	Coil Resistance ( $\Omega$ ) $\pm 10\%$	Must operate voltage max. (V AC)	Must release voltage min (V AC)	Max. allowable voltage (V AC)
24	24	253	19.2	7.2	26.4
110	110	5819	88.0	33	121
230	230	23276	184	69	253

**Insulation**

Insulation resistance (coil to contact)	$\geq 100 M\Omega$ @ 500V DC, 50% RH
Dielectric strength	5 kV
Contact/coil	5000 Vrms, 1 min
Contact/contact	1000 Vrms, 1 min

**Specifications**

Ambient temperature operation/storage	-55 ... 70 °C / -55...70 °C (no ice)
Pick-up time	10ms
Release time	5 ms
Mechanical/electrical life ops	$\geq 1 \times 10\,000\,000 / 1 \times 100\,000$
Weight	17 g
Max. switching frequency	20Hz
Tightness	RT2

**Product References**

**V AC 50 Hz/60 Hz: 24, 110 (120), 230 (240)**  
**V DC 12, 24, 48**

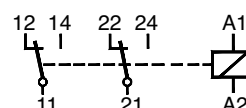
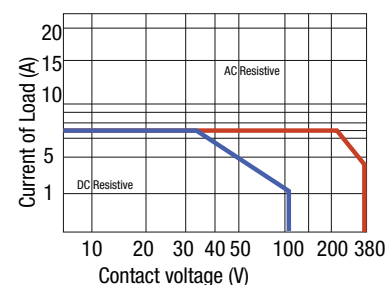
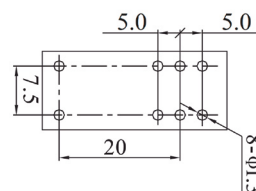
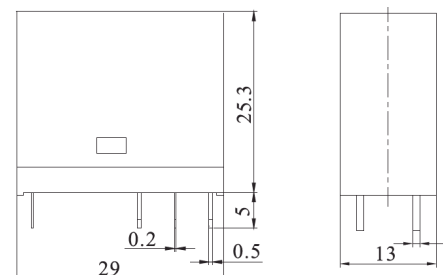
**C16-A25PTL/AC...V**  
**C16-A25PTL/DC...V**

Other voltages on request

"..." List Coil Voltage to complete Product References

**Accessories**

Socket	<b>S16-M</b>
Retaining clip, plastic	<b>CP-16</b>
Modules	<b>See datasheet socket S16-M</b>

**Connection diagram****fig. 1 Max. Operating Power Curve****Dimensions (mm)****Technical approvals, conformities**

IEC/EN 61810; IEC/EN 60947

# C18-A15PT

1 pole | 5-pin | changeover contact | Grid 3.5mm

<b>Maximum contact load</b>	<b>10 A/250V AC-1</b>
	<b>10 A/30V DC-1</b>
<b>Recommended minimum contact load</b>	<b>1 mA/1V AC/DC</b>

### Contacts

Material	⚡ AgSnO <sub>2</sub>
Rated Load	10A
Switching voltage max.	250V
Max. inrush current (500ms)	25A
Bounce time	2 ms

### Coil

Coil resistance	see table; tolerance ± 10 %
Pick-up voltage	75 % of U <sub>N</sub> (DC) / 80 % of U <sub>N</sub> (AC)
Release voltage	≤ 0.1 U <sub>N</sub> (DC) / ≤ 0.3 U <sub>N</sub> (AC)
Nominal power	1 VA (AC) / 0.53 W (DC) @ 23 °C

### Coil Data (DC voltage)

Coil Voltage Code	Nominal Voltage (VDC)	Coil Resistance (Ω) ± 10 %	Must operate voltage max. (VDC)	Must release voltage min (VDC)
12	12	270	9.00	1.2
24	24	1080	18.00	2.4
36	36	1350	27.00	3.6
48	48	4340	36.00	4.8
110	110	22830	82.5	11

### Coil Data (AC voltage 50/60 Hz)

Coil Voltage Code	Nominal Voltage (VAC)	Coil Resistance (Ω) ± 10 %	Must operate voltage max. (VAC)	Must release voltage min (VAC)	Max. allowable voltage (VAC)
24	24	253	19.2	7.2	26.4
110	110	5819	88.0	33	121
230	230	23276	184	69	253

### Insulation

Insulation resistance (coil to contact)	≥ 100 MΩ @ 500V DC, 50% RH
Dielectric strength	5 kV
Contact/coil	5000Vrms, 1 min
Contact/contact	1000Vrms, 1 min

### Specifications

Ambient temperature operation/storage	-55 ... 70 °C / -55...70 °C (no ice)
Pick-up time	10ms
Release time	5ms
Mechanical / electrical life ops	≥ 1 × 10 000 000 / 1 × 100 000
Weight	17g
Max. switching frequency	20Hz
Tightness	RT2

### Product References

**V AC 50 Hz/60 Hz: 24, 110 (120), 230 (240)**

**V DC 12, 24, 36, 48, 110**

Other voltages on request

**C18-A15PT/AC...V**  
**C18-A15PT/DC...V**

"..." List Coil Voltage to complete Product References

### Accessories

Socket	<b>S18-M</b>
Retaining clip, plastic	<b>CP-16</b>
Modules	<b>See datasheet socket S18-M</b>



### Connection diagram

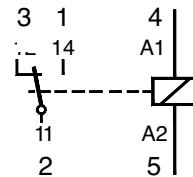
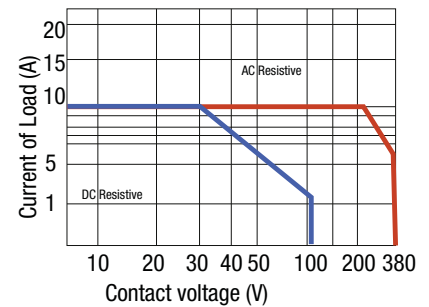
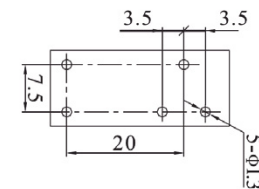
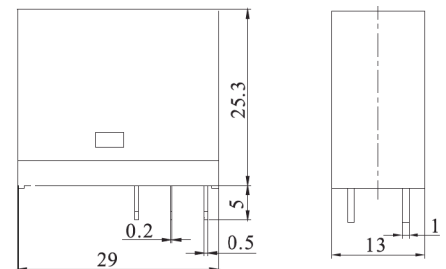


fig. 1 Max. Operating Power Curve



### Dimensions (mm)



Standard

### Technical approvals, conformities



IEC/EN 61810; IEC/EN 60947

# C18-A15PTL

1 pole | 5-pin | changeover contact | Grid 5mm

<b>Maximum contact load</b>	<b>10 A/250V AC-1</b>
	<b>10 A/30V DC-1</b>
<b>Recommended minimum contact load</b>	<b>1 mA/1V AC/DC</b>

### Contacts

Material	⚡ AgSnO <sub>2</sub>
Rated Load	10A
Switching voltage max.	250V
Max. inrush current (500 ms)	25A
Bounce time	2 ms

### Coil

Coil resistance	see table; tolerance ± 10 %
Pick-up voltage	75 % of U <sub>N</sub> (DC) / 80 % of U <sub>N</sub> (AC)
Release voltage	≤ 0.1 U <sub>N</sub> (DC) / ≤ 0.3 U <sub>N</sub> (AC)
Nominal power	1 VA (AC) / 0.53 W (DC) @ 23 °C

### Coil Data (DC voltage)

Coil Voltage Code	Nominal Voltage (V DC)	Coil Resistance (Ω) ± 10 %	Must operate voltage max. (VDC)	Must release voltage min (VDC)
12	12	270	9.00	1.2
24	24	1080	18.00	2.4
36	36	1350	27.00	3.6
48	48	4340	36.00	4.8
110	110	22830	82.5	11

### Coil Data (AC voltage 50/60Hz)

Coil Voltage Code	Nominal Voltage (VAC)	Coil Resistance (Ω) ± 10 %	Must operate voltage max. (VAC)	Must release voltage min (VAC)	Max. allowable voltage (VAC)
24	24	253	19.2	7.2	26.4
110	110	5819	88.0	33	121
230	230	23276	184	69	253

### Insulation

Insulation resistance (coil to contact)	≥ 100 MΩ @ 500V DC, 50 % RH
Dielectric strength	5 kV
Contact/coil	5000 Vrms, 1 min
Contact/contact	1000 Vrms, 1 min

### Specifications

Ambient temperature operation/storage	-55 ... 70 °C / -55...70 °C (no ice)
Pick-up time	10ms
Release time	5 ms
Mechanical/electrical life ops	≥ 1 × 10 000 000 / 1 × 100 000
Weight	17g
Max. switching frequency	20Hz
Tightness	RT2

### Product References

**V AC 50 Hz/60 Hz: 24, 110 (120), 230 (240)**  
**V DC 12, 24, 36, 48, 110**

**C18-A15PTL/AC...V**  
**C18-A15PTL/DC...V**

Other voltages on request

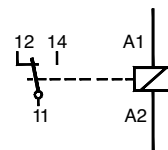
"..." List Coil Voltage to complete Product References

### Accessories

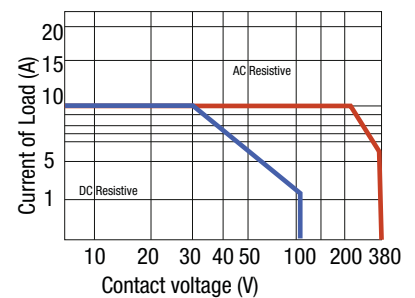
Socket	<b>S16-M</b>
Retaining clip, plastic	<b>CP-16</b>
Modules	<b>See datasheet socket S16-M</b>



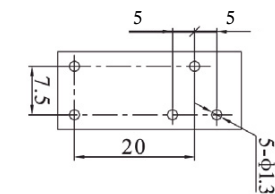
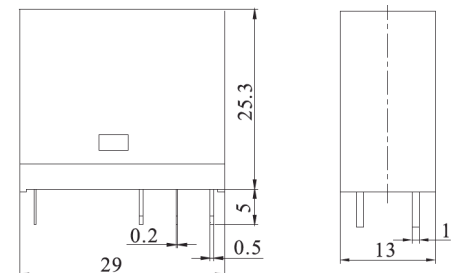
### Connection diagram



**fig. 1 Max. Operating Power Curve**



### Dimensions (mm)



Standard

### Technical approvals, conformities



IEC/EN 61810; IEC/EN 60947

# C18-B15PTL

1 pole | 8-pin | changeover contact | Grid 5mm

<b>Maximum contact load</b>	<b>16 A/250V AC-1</b>
	<b>16 A/30V DC-1</b>
<b>Recommended minimum contact load</b>	<b>1 mA/1V AC/DC</b>

### Contacts

Material	⚡ AgSnO <sub>2</sub>
Rated Load	16A
Switching voltage max.	250V
Max. inrush current (500ms)	25A
Bounce time	2ms

### Coil

Coil resistance	see table; tolerance ± 10 %
Pick-up voltage	75 % of U <sub>N</sub> (DC) / 80 % of U <sub>N</sub> (AC)
Release voltage	≤ 0.1 U <sub>N</sub> (DC) / ≤ 0.3 U <sub>N</sub> (AC)
Nominal power	1 VA (AC) / 0.53 W (DC) @ 23 °C

### Coil Data (DC voltage)

Coil Voltage Code	Nominal Voltage (VDC)	Coil Resistance (Ω) ± 10 %	Must operate voltage max. (VDC)	Must release voltage min (VDC)
12	12	270	9.00	1.2
24	24	1080	18.00	2.4
36	36	1350	27.00	3.6
48	48	4340	36.00	4.8
110	110	22830	82.5	11

### Coil Data (AC voltage 50/60 Hz)

Coil Voltage Code	Nominal Voltage (VAC)	Coil Resistance (Ω) ± 10 %	Must operate voltage max. (VAC)	Must release voltage min (VAC)	Max. allowable voltage (VAC)
24	24	253	19.2	7.2	26.4
110	110	5819	88.0	33	121
230	230	23276	184	69	253

### Insulation

Insulation resistance (coil to contact)	≥ 100 MΩ @ 500V DC, 50% RH
Dielectric strength	5 kV
Contact/coil	5000Vrms, 1 min
Contact/contact	1000Vrms, 1 min

### Specifications

Ambient temperature operation/storage	-55 ... 70 °C / -55...70 °C (no ice)
Pick-up time	10ms
Release time	5ms
Mechanical / electrical life ops	≥ 1 × 10 000 000 / 1 × 100 000
Weight	17g
Max. switching frequency	20Hz
Tightness	RT2

### Product References

**V AC 50 Hz/60 Hz: 24, 110 (120), 230 (240)**

**V DC 12, 24, 36, 48, 110**

Other voltages on request

**C18-B15PTL/AC...V**  
**C18-B15PTL/DC...V**

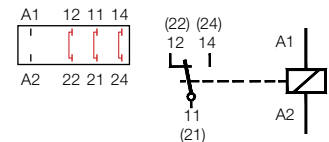
"..." List Coil Voltage to complete Product References

### Accessories

Socket	<b>S16-M</b>
Retaining clip, plastic	<b>CP-16</b>
Modules	<b>See datasheet socket S16-M</b>

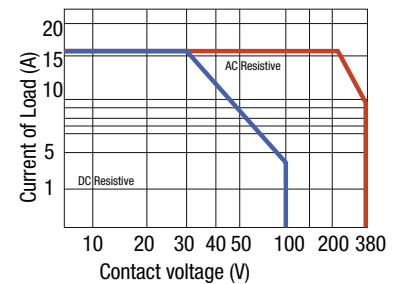


### Connection diagram

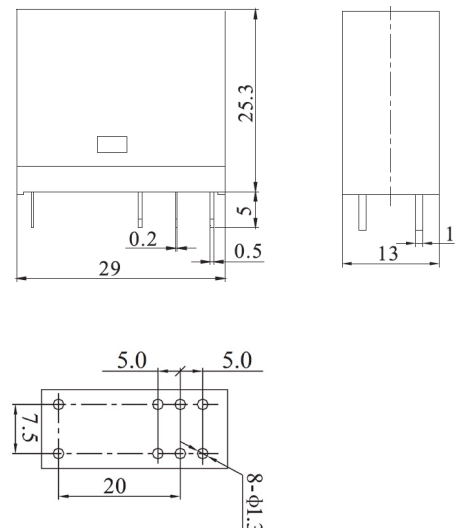


**⚠** For usage of the relay up to 16A, pin 22+12 (open), pin 21+11 (common) and pin 24+14 (closing) need to be bridged on the socket terminals to prevent overheating. Each contact on this relay is connected to two pins each.

**fig. 1 Max. Operating Power Curve**



### Dimensions (mm)



### Technical approvals, conformities



IEC/EN 61810; IEC/EN 60947



## 1.2 Interface Relays

---

Application	Type	Page
<b>CRINT Series</b>		
1 pole   changeover contact	CRINT-1x1	27
1 pole   changeover contact	CRINT-1x2	28
1 pole   normally open solid state DC	CRINT-1x5	78
1 pole   normally open solid state AC	CRINT-1x8	79
<b>CINT Series</b>		
1 pole   changeover contact	CINT-51 / CINT-61	29
2 pole   changeover contact	CINT-52 / CINT-62	30
2 pole   changeover contact	CINT-53 / CINT-63	31
<b>CHA Series</b>		
1 pole changeover contact, 1 pole auxiliary contact	CHA1	32

### CRINT Product Key

1		2	3	4	5	6	7	8	
<b>CRINT</b>	<b>-</b>	<b>C</b>	<b>1</b>	<b>1</b>	<b>1</b>	<b>R</b>	<b>/</b>	<b>UC</b>	<b>24V</b>

#### 1. Product family

CRINT

#### 2. Type

C = Combined version (Socket and Relay)

#### 3. Contact

1 = One change-over contact

#### 4. Connection type

1 = Screw terminal

2 = Cage clamp terminal

#### 5. Output

1 = AgSnO<sub>2</sub>

2 = AgSnO<sub>2</sub> + 3μ Au

5 = NO / Solid-state DC

8 = NO / Solid-state AC

#### 6. Options

- = Standard version

R = Railway version

#### 7. Supply voltage

UC = AC/DC

DC = Only for C1x5 and C1x8

#### 8. Nominal voltage

12V, 24V, 48V, 60V, 110-125V, 220-240V

### RELAY Only

1		2	3	4	5
<b>CRINT</b>	<b>-</b>	<b>R</b>	<b>11</b>	<b>DC</b>	<b>12V</b>

#### 1. Product family

CRINT

#### 2. Type

R = Relay

#### 4. Supply voltage

DC

#### 5. Nominal voltage

12 V, 24 V, 48 V, 60 V\*

#### 3. Contact

11 = AgSnO<sub>2</sub>

12 = AgSnO<sub>2</sub> + 3μ Au

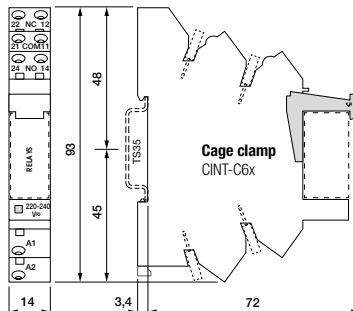
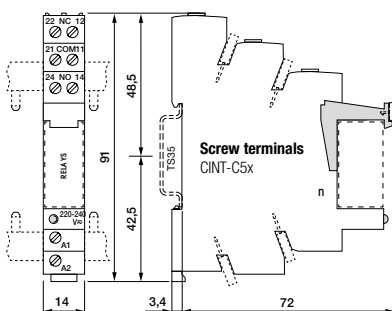
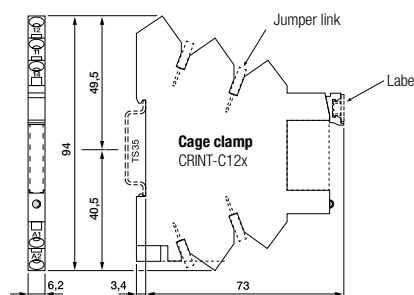
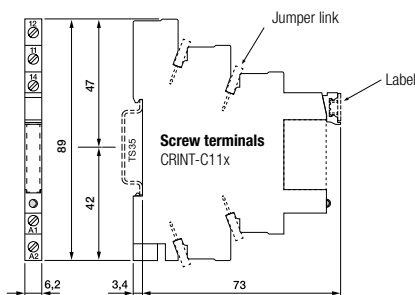
15 = NO / Solid-state DC

18 = NO / Solid-state AC

\*60 V Relay used for all sockets with a nominal voltage higher or equal 60V

### CRINT-C1xx & CINT-C5x/C6x

### Dimensions (mm)



**CRINT 1x1 series**

**1 pole | changeover contact**

<b>Maximum contact load</b>	<b>6 A/250 V AC-1</b>	<b>6 A/30 V DC-1</b>
<b>Recommended minimum contact load</b>	<b>100 mA / 12 V</b>	

**Contact**

Type	1 CO
Material	⚡ AgSnO <sub>2</sub>
Switching current   <sub>TH</sub>	6 A 250 V AC
Switching power DC-1 30 V	180 W
Switching power AC-1 230 V	1500 VA
Switching power AC-15 230 V	300 VA
Max. inrush current (2.5 ms)	15 A

**Coil**

Operation voltage AC 50/60 Hz / DC	0.8 ... 1.25 U <sub>N</sub>
Nominal power DC/AC	408 / 900 mW

**Insulation**

Test voltage I / O	6 kV rms / 1 min
Pollution degree	3
Over voltage category	III
Open contact	1000 Vrms dielectric strength 1 min
Standard	EN61810-1

**Specifications**

Ambient temperature: operation / storage	-40 ... 70 °C / -40 ... 85 °C (no ice)
Typical response time @ V <sub>n</sub>	7 ms
Typical release time @ V <sub>n</sub>	15 ms
Switching cycles: mech./elec.	10 x 1 000 000 / 3 x 10 000
Cond. cross section screw terminal	2.5 mm <sup>2</sup>
Cond. cross section spring cage	0.75 ... 2.5 mm <sup>2</sup>
Protection degree	IP 20
Mounting position	any, TS35 or Back Panel Mounting
Weight	30 g

**Product References**

Screw terminal

**UC 12V, 24V, 48V, 60V, 110-125V, 220-240V**

**CRINT-C111/UC...V**

Cage clamp terminal

**UC 12V, 24V, 48V, 60V, 110-125V, 220-240V**

**CRINT-C121/UC...V**

**Railway EN 50155**

...“ List Coil Voltage to complete Product References

**CRINT-C121R/UC...V**

**Accessories**

Jumper link	blue: <b>CRINT-BR20-BU (BAG 5 PCS)</b>
	red: <b>CRINT-BR20-RD (BAG 5 PCS)</b>
	black: <b>CRINT-BR20-BK (BAG 5 PCS)</b>

Label plate

**CRINT-LAB (BAG 4x16 PCS)**

Spacer

**CRINT-SEP (BAG 5 PCS)**

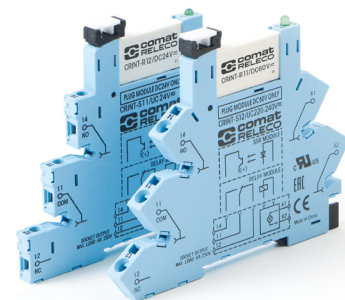
**Replacement relays**

**DC 12V, 24V, 48V, 60V\***

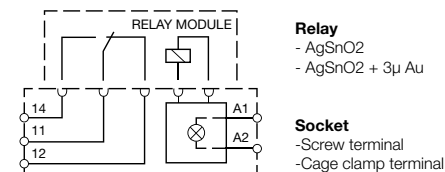
**CRINT-R11/DC...V**

...“ List Coil Voltage to complete Product References

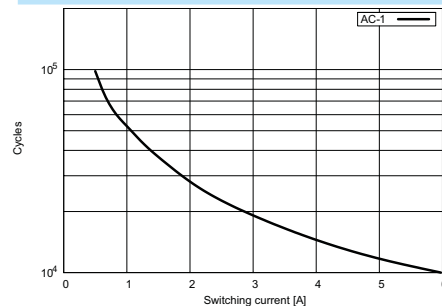
\*60V Relay used for all sockets with a nominal voltage higher or equal 60V



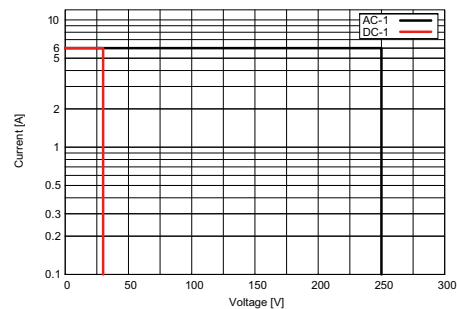
**Connection diagram**



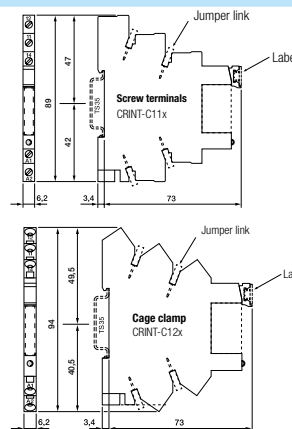
**fig. 1 AC voltage endurance**



**fig. 2 DC load limit curve**



**Dimensions (mm)**



**Technical approvals, conformities**



IEC/EN 61810, IEC/EN 50155, IEC/EN 45545

## 1.2 Interface Relays

### CRINT 1x2 series

#### 1 pole | changeover contact

<b>Maximum contact load</b>	<b>6 A/250 V AC-1</b>	<b>6 A/30 V DC-1</b>
<b>Recommended minimum contact load</b>	<b>10 mA / 6 V</b>	

#### Contact

Type	1 CO
Material	AgSnO <sub>2</sub> + 5μ Au
Switching current   <sub>TH</sub>	6 A 250 V AC
Switching power DC-1 30 V	180 W
Switching power AC-1 230 V	1500 VA
Switching power AC-15 230 V	300 VA
Max. inrush current (2.5 ms)	15 A

#### Coil

Operation voltage AC 50/60 Hz / DC	0.8 ... 1.25 U <sub>N</sub>
Nominal power DC/AC	408 / 900 mW

#### Insulation

Test voltage I / O	6 kV rms / 1 min
Pollution degree	3
Over voltage category	III
Open contact	1000 Vrms dielectric strength 1 min
Standard	EN61810-1

#### Specifications

Ambient temperature: operation / storage	-40 ... 70 °C / -40 ... 85 °C (no ice)
Typical response time @ V <sub>n</sub>	7 ms
Typical release time @ V <sub>n</sub>	15 ms
Switching cycles: mech./elec.	10 x 1 000 000 / 3 x 10 000
Cond. cross section screw terminal	2.5 mm <sup>2</sup>
Cond. cross section spring cage	0.75 ... 2.5 mm <sup>2</sup>
Protection degree	IP 20
Mounting position	any, TS35 or Back Panel Mounting
Weight	30 g

#### Product References

Screw terminal

**UC 12V, 24V, 48V, 60V, 110-125V, 220-240V**

**CRINT-C112/UC...V**

Cage clamp terminal

**UC 12V, 24V, 48V, 60V, 110-125V, 220-240V**

**CRINT-C122/UC...V**

**Railway EN 50155**

...“ List Coil Voltage to complete Product References

**CRINT-C122R/UC...V**

#### Accessories

Jumper link

blue:	<b>CRINT-BR20-BU (BAG 5 PCS)</b>
red:	<b>CRINT-BR20-RD (BAG 5 PCS)</b>
black:	<b>CRINT-BR20-BK (BAG 5 PCS)</b>

Label plate

Spacer

**CRINT-LAB (BAG 4x16 PCS)**  
**CRINT-SEP (BAG 5 PCS)**

#### Replacement relays

**DC 12V, 24V, 48V, 60V\***

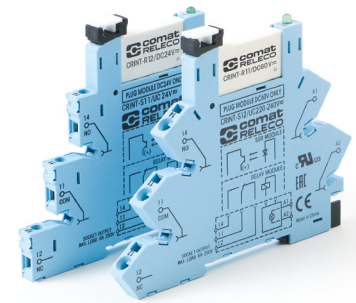
**CRINT-R12/DC...V**

...“ List Coil Voltage to complete Product References

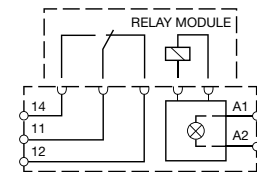
\*60V Relay used for all sockets with a nominal voltage higher or equal 60V



**comat**  
**RELECO**



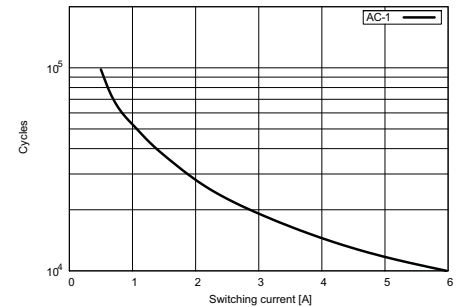
#### Connection diagram



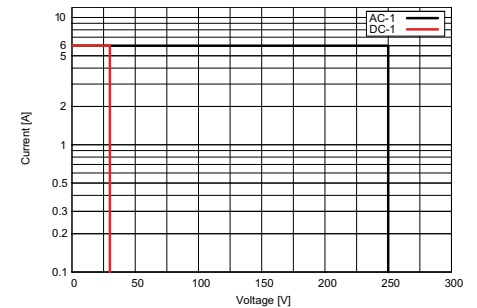
**Relay**  
- AgSnO<sub>2</sub>  
- AgSnO<sub>2</sub> + 3μ Au

**Socket**  
- Screw terminal  
- Cage clamp terminal

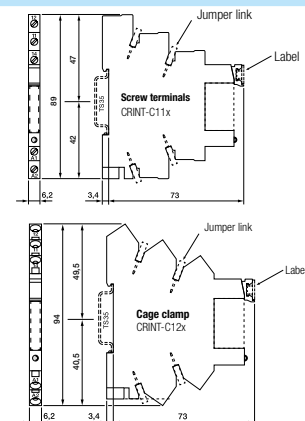
**fig. 1 AC voltage endurance**



**fig. 2 DC load limit curve**



#### Dimensions (mm)



#### Technical approvals, conformities



IEC/EN 61810, IEC/EN 50155, IEC/EN 45545

## 1.2 Interface Relays

**CINT-51 / CINT-61**
**1 pole | changeover contact**

<b>Maximum contact load</b>	<b>10 A (16 A)/250 V AC-1</b>
<b>Recommended minimum contact load</b>	<b>10 mA / 24 V</b>

**Contact**

Type	1 CO
Material	AgSnO <sub>2</sub>
Switching current   <sub>TH</sub>	16 A
Max. inrush current (5 ms)	30 A

**Coil**

Operation voltage AC 50/60 Hz / DC	0.7 ... 1.25 U <sub>N</sub>
Nominal power DC/AC	480 mW / 780 mW

**Insulation**

Test voltage I / O	4000 Vrms / 1min
Pollution degree	3
Over voltage category	III
Open contact	1000 Vrms
Standard	EN61810-1

**Specifications**

Ambient temperature: operation / storage	-20 ... 55 °C / -40 ... 85 °C (no ice)
Typical response time @ V <sub>n</sub>	5 ms
Typical release time @ V <sub>n</sub>	10 ms
Cond. cross section screw terminal	2.5 mm <sup>2</sup>
Cond. cross section spring cage	0.5 ... 2.5 mm <sup>2</sup>
Protection degree	IP 20
Mounting position	any
Weight	63 g

**Product References**

Screw terminal

**UC24V, AC230V** **CINT-51/...V**

Cage clamp terminal

**UC24V, AC230V** **CINT-61/...V**

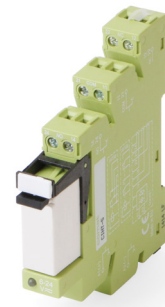
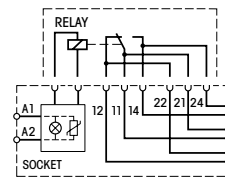
 „...“ List Coil Voltage to complete  
Product References

**Accessories**

 Jumper link black: **CINT-BR8/5**

 Label plate **CINT5-BEZ/18**
**Replacement relays**
**DC 24V, 110V** **CINT-R21/DC...V**

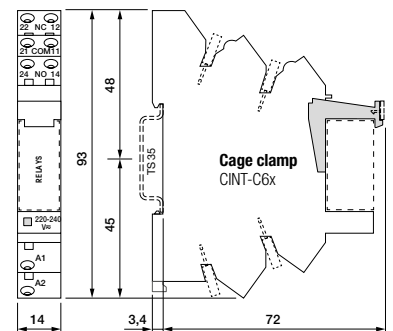
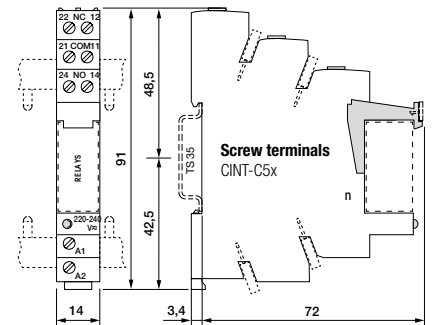
 „...“ List Coil Voltage to complete  
Product References

 \*24V Relay used for 24 V sockets,  
110V Relay used for 230V sockets.

**Connection diagram**

**fig. 1 AC voltage endurance**

on request

**fig. 2 DC load limit curve**

on request

**Dimensions (mm)**

**Technical approvals, conformities**
  
IEC/EN 61810

## 1.2 Interface Relays

### CINT-52 / CINT-62

#### 2 pole | changeover contact

<b>Maximum contact load</b>	<b>8 A/250 V AC-1</b>
<b>Recommended minimum contact load</b>	<b>5 mA / 5 V</b>

#### Contact

Type	2 CO
Material	AgNi + 5μ Au
Switching current   <sub>TH</sub>	8 A
Max. inrush current (20 ms)	15 A

#### Coil

Operation voltage AC 50/60 Hz / DC	0.7 ... 1.25 U <sub>N</sub>
Nominal power DC/AC	480 mW / 780 mW

#### Insulation

Test voltage I / O	4000 Vrms / 1min
Pollution degree	3
Over voltage category	III
Open contact	1000 Vrms
Standard	EN61810-1

#### Specifications

Ambient temperature: operation / storage	-20 ... 55 °C / -40 ... 85 °C (no ice)
Typical response time @ V <sub>n</sub>	5 ms
Typical release time @ V <sub>n</sub>	10 ms
Cond. cross section screw terminal	2.5 mm <sup>2</sup>
Cond. cross section spring cage	0.5 ... 2.5 mm <sup>2</sup>
Protection degree	IP 20
Mounting position	any
Weight	63 g

#### Product References

Screw terminal

**UC24V, AC230V**

**CINT-52/...V**

Cage clamp terminal

**UC24V, AC230V**

**CINT-62/...V**

„...“ List Coil Voltage to complete  
Product References

#### Accessories

Jumper link black: **CINT-BR8/5**

Label plate **CINT5-BEZ/18**

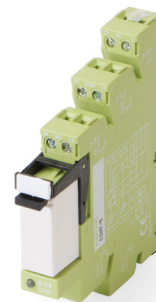
#### Replacement relays

**DC 24V, 110V**

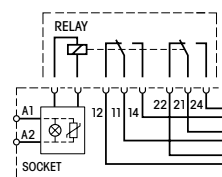
**CINT-R22/DC...V**

„...“ List Coil Voltage to complete  
Product References

\*24V Relay used for 24 V sockets,  
110V Relay used for 230V sockets.



#### Connection diagram



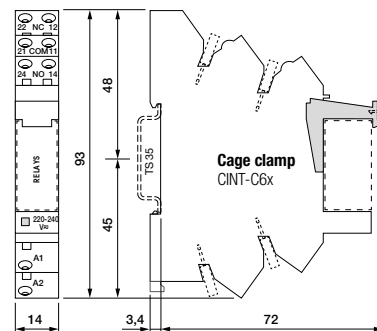
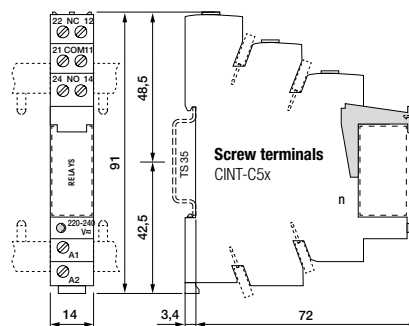
**fig. 1 AC voltage endurance**

on request

**fig. 2 DC load limit curve**

on request

#### Dimensions (mm)



#### Technical approvals, conformities



## 1.2 Interface Relays

**CINT-53 / CINT-63**
**2 pole | changeover contact**

<b>Maximum contact load</b>	<b>8 A/250 V AC-1</b>
<b>Recommended minimum contact load</b>	<b>10 mA / 24 V</b>
<b>Contact</b>	
Type	2 CO
Material	⚡ AgNi
Switching current   <sub>TH</sub>	8 A
Max. inrush current (20 ms)	15 A
<b>Coil</b>	
Operation voltage AC 50/60 Hz / DC	0.7 ... 1.25 U <sub>N</sub>
Nominal power DC/AC	480 mW / 780 mW
<b>Insulation</b>	
Test voltage I / O	4000 Vrms / 1min
Pollution degree	3
Over voltage category	III
Open contact	1000 Vrms
Standard	EN61810-1
<b>Specifications</b>	
Ambient temperature: operation / storage	-20 ... 55 °C / -40 ... 85 °C (no ice)
Typical response time @ V <sub>n</sub>	5 ms
Typical release time @ V <sub>n</sub>	10 ms
Cond. cross section screw terminal	2.5 mm <sup>2</sup>
Cond. cross section spring cage	0.5 ... 2.5 mm <sup>2</sup>
Protection degree	IP 20
Mounting position	any
Weight	63 g

**Product References**

Screw terminal

**UC24V, AC230V**
**CINT-53/...V**

Cage clamp terminal

**UC24V, AC230V**
**CINT-63/...V**

 „...“ List Coil Voltage to complete  
Product References

**Accessories**

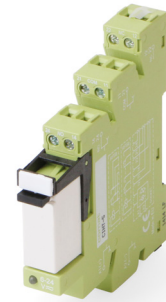
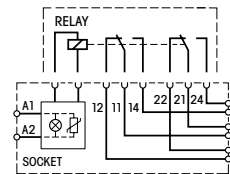
Jumper link

 black: **CINT-BR8/5**

Label plate

**CINT5-BEZ/18**
**Replacement relays**
**DC 24V, 110V**
**CINT-R23/DC...V**

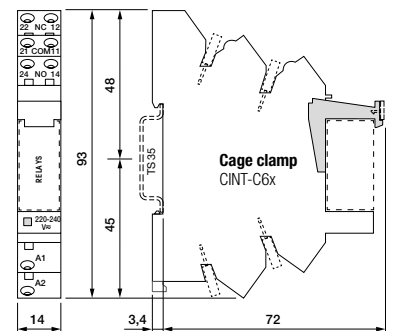
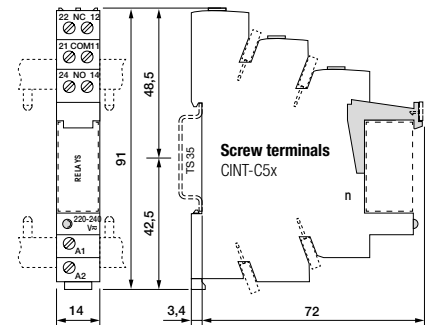
 „...“ List Coil Voltage to complete  
Product References

 \*24V Relay used for 24 V sockets,  
110V Relay used for 230V sockets.

**Connection diagram**

**fig. 1 AC voltage endurance**

on request

**fig. 2 DC load limit curve**

on request

**Dimensions (mm)**

**Technical approvals, conformities**


IEC/EN 61810

**CHA1**

**1 pole changeover contact, 1 pole auxiliary contact**

<b>Maximum contact load</b>	<b>10 A/250 V AC-1</b>	<b>0.3 A/24 V DC-1</b>
<b>Recommended minimum contact load</b>	<b>10 mA / 12 V</b>	
<b>Contact</b>		
Type	1CO	1NC
Material	⚡ AgSnO <sub>2</sub>	⚡ AgNi
Switching current   <sub>TH</sub>	10 A	0.3 A
Max. inrush current (20 ms)	15 A	-

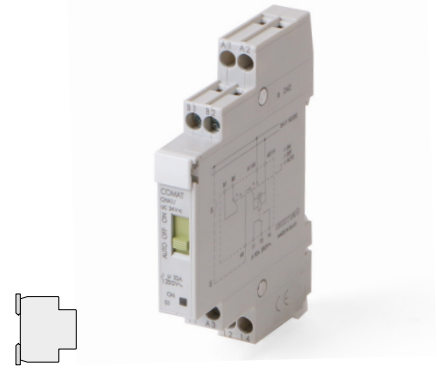
<b>Coil</b>		
Operation voltage AC 50/60 Hz / DC	0.8 ... 1.1 U <sub>N</sub>	
Nominal power DC/AC	400 mW / 400 mW	

<b>Insulation</b>		
Test voltage I / O	3000 Vrms / 1min	
Pollution degree	3	
Over voltage category	III	
Open contact	1000 Vrms	
Standard	EN61810-1	

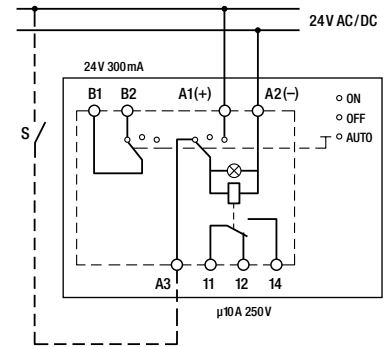
<b>Specifications</b>		
Ambient temperature: operation / storage	-20 ... 55 °C / -40 ... 85 °C (no ice)	
Typical response time @ V <sub>n</sub>	on request	
Typical release time @ V <sub>n</sub>	on request	
Cond. cross section screw terminal	2.5 mm <sup>2</sup>	
Protection degree	IP 20	
Mounting position	any	
Weight	42 g	

**Product References**

**CHA1/UC24V**



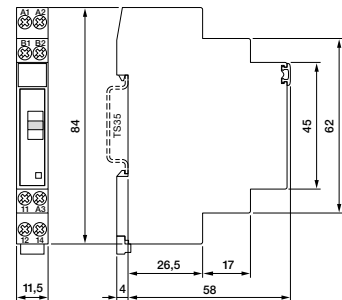
**Connection diagram**



**Function Table**

Green ON-OFF-switch	Control input A3	Relay / LED	Check back contact
AUTO	1	1	1
	0	0	1
ON	-	1	0
OFF	-	0	0

**Dimensions (mm)**





















**Technical approvals, conformities**















IEC/EN 61810



## 1.3 Industrial Relays - pluggable

Application	Type	Pin	Page
<b>C2 Series</b>			
2 pole   changeover contact	C2-A2x		36
<b>C3 Series</b>			
3 pole   changeover contact	C3-A3x		37
3 pole   changeover twin contact	C3-T3x		38
3 pole   normally open contact	C3-G3x		39
1 pole   normally open serial contact with blow magnet	C3-M1x		40
1 pole   normally open serial contact	C3-X1x		41
2 pole   changeover contact   remanance	C3-R2x		42
3 pole   changeover contact   sensitive coil	C3-N3x		43
<b>C4 Series</b>			
4 pole   changeover contact   Faston	C4-A4x		44
2 pole   normally open serial contact   Faston	C4-X2x		45
3 pole   changeover contact   remanance	C4-R3x		46
<b>C5 Series</b>			
2 pole   changeover contact   Faston	C5-A2x		47
3 pole   changeover contact   Faston	C5-A3x		48
3 pole   normally open contact   Faston	C5-G3x		49
1 pole   normally open serial contact   Faston	C5-X1x		50
1 pole   normally open serial contact with blow magnet   Faston	C5-M1x		51
2 pole   normally open contact with blow magnet   Faston	C5-M2x		52
2 pole   changeover contact   remanance	C5-R2x		53



Application	Type	Pin	Page
<b>C7 Series</b>			
1 pole   changeover contact   Faston	C7-A1x		54
2 pole   changeover contact   Faston	C7-A2x		55
2 pole   changeover twin contact	C7-T2x		56
2 pole   normally open contact   Faston	C7-G2x		57
2 pole   changeover contact   Faston	C7-H2x		58
1 pole   normally open serial contact   Faston	C7-X1x		59
1 pole   normally open tungsten pre-contact   Faston	C7-W1x		60
<b>R7 Series</b>			
2 pole   changeover contact   Faston	R7-A2x		61
2 pole   changeover twin contact	R7-T2x		62
<b>C9 Series</b>			
4 pole   changeover contact   Faston	C9-A4x		63
2 pole   changeover contact   sensitive coil   Faston	C9-E2x		64
2 pole   changeover contact   remanance   Faston	C9-R2x		65

## C2-A2x

### 2 pole | changeover contact

<b>Maximum contact load</b>	<b>10 A/250 V AC-1</b>	<b>0.5 A/110 V DC-1</b>
	<b>10 A/30 V DC-1</b>	<b>0.2 A/220 V DC-1</b>
<b>Recommended minimum contact load</b>	<b>10 mA/10 V Code 0</b>	
	<b>5 mA/5 V Code 8</b>	

#### Contacts

Material	Standard	Code 0	AgNi
	Optional	Code 8	AgNi + 5 μ Au
Max. switching current	10 A		
Max. peak inrush current (20 ms.)	30 A		
Max. switching voltage	250 V		
Max. AC load fig. 1	2.5 kVA		
Max. DC load	See fig. 2		

#### Coils

Coil resistance	see table; tolerance ± 10 %
Pick up voltage	≤ 0.8 × U <sub>n</sub>
Pick up voltage	≥ 0.1 × U <sub>n</sub>
Nominal power	2.2 VA (AC)/1.3 W (DC)

#### Coil Table

V AC	Ω	mA	V DC	Ω	mA
24	67	92	24	443	54
48	296	46	48	1K8	27
115	1K7	19	110	9K	12
230	7K1	9.5	220	36K1	6

#### Insulation

	Volt rms / 1 min
Open contact	1000 V
Between adjacent poles	2.5 kV
Between contacts and coil	2.5 kV
Insulation resistance at 500 V	≥ 1 GΩ
Insulation, IEC 61810-1	2.5 kV

#### Specifications

Ambient temperature operation/storage	-40...60 °C / -40 ... 80 °C (no ice)
Pick-up time + bounce time	16 ms / ≤ 3 ms
Release time + bounce time	8 ms / ≤ 1 ms
Mechanical life ops	AC: 10 Mill./DC: 20 Mill.
DC voltage endurance at rated load	≥ 100 000 ops. switching cycles
Max. switching frequency at rated load	1200/h
Weight	79 g

#### Product References

V AC 50 Hz/60 Hz: 24, 48, 115 (120), 230 (240)

LED

RC Suppressor

V DC 24, 48, 110, 220

LED

Free wheeling diode

Polarity and free wheeling diode

AC/DC bridge rectifier 24 V, 48 V, 60 V

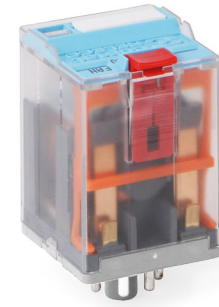
Other voltages on request

C2-A20/AC ... V	C2-A28/AC ... V
C2-A20X/AC ... V	C2-A28X/AC ... V
C2-A20R/AC ... V	C2-A28R/AC ... V
C2-A20/DC ... V	C2-A28/DC ... V
C2-A20X/DC ... V	C2-A28X/DC ... V
C2-A20DX/DC ... V	C2-A28DX/DC ... V
C2-A20FX/DC ... V	C2-A28FX/DC ... V
C2-A20BX/UC ... V	C2-A28BX/UC ... V

"..." List Coil Voltage to complete Product References

#### Accessories (See also Section Sockets)

Socket	<b>S2-B, S2-PO</b>
Blanking Plug	<b>SO-NP (BAG 10 PCS)</b>



#### Connection diagram

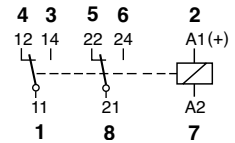


fig. 1 AC voltage endurance

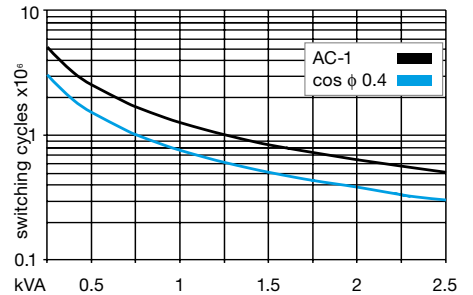
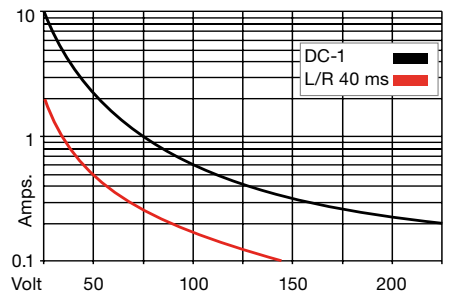
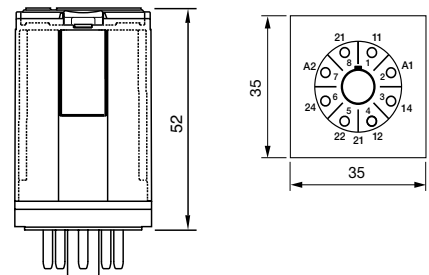


fig. 2 DC load limit curve



#### Dimensions (mm)



#### Technical approvals, conformities



IEC/EN 61810; IEC/EN 60947

## C3-A3x

### 3 pole | changeover contact

<b>Maximum contact load</b>	<b>10 A/250</b>	<b>AC-1</b>	<b>0.5 A/110 V</b>	<b>DC-1</b>
	<b>10 A/30</b>	<b>DC-1</b>	<b>0.2 A/220 V</b>	<b>DC-1</b>
<b>Recommended minimum contact load</b>	<b>10 mA/10 V</b>	<b>Code 0, 9</b>		
	<b>5 mA/5 V</b>	<b>Code 8</b>		

#### Contacts

Material	Standard	Code 0	⚡ AgNi
	Optional	Code 8	⚡ AgNi + 5 μ Au
	Optional	Code 9	⚡ AgNi + 0.2 μ Au
Rated Load			10 A
Max. inrush current (20 ms)			30 A
Switching voltage max.			250 V
AC load fig. 1			2.5 kVA
DC load			see fig. 2

#### Coil

Coil resistance	see table; tolerance ± 10 %
Pick-up voltage	≤ 0.8 × U <sub>n</sub>
Release voltage	≥ 0.1 × U <sub>n</sub>
Nominal power	2.2 VA (AC)/1.3 W (DC)

#### Coil table

V AC	Ω	mA	V DC	Ω	mA
24	67	92	24	480	50
48	296	46	48	1K8	26
115	1K7	19	110	9K	12
230	7K1	9.5	220	36K1	6

#### Insulation

Contact open	1000 V
Contact/contact	2.5 kV
Contact/coil	2.5 kV
Insulation resistance at 500 V	≥ 1 GΩ
Insulation, IEC 61810-1	2.5 kV

#### Specifications

Ambient temperature operation/storage	-40...60 °C / -40 ... 80 °C (no ice)
Pick-up time/bounce time	16 ms / ≤ 3 ms
Release time/bounce time	8 ms / ≤ 1 ms
Mechanical life ops	AC: 10 Mill./DC: 20 Mill.
DC voltage endurance at rated load	≥ 100 000 switching cycles
Max. switching frequency at rated load	1200/h
Weight	81 g

#### Product References

V AC 50 Hz/60 Hz: 24, 48, 115 (120), 230 (240)

LED

RC Suppressor

V DC 24, 48, 110, 220

LED

Free wheeling diode

Polarity and free wheeling diode

AC/DC bridge rectifier 24 V, 48 V, 60 V

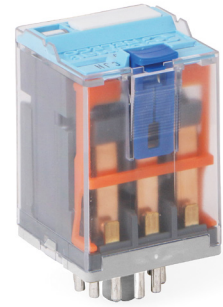
Other voltages on request

C3-A30/AC ... V	C3-A38/AC ... V	C3-A39/AC ... V
C3-A30X/AC ... V	C3-A38X/AC ... V	C3-A39X/AC ... V
C3-A30R/AC ... V	C3-A38R/AC ... V	C3-A39R/AC ... V
C3-A30/DC ... V	C3-A38/DC ... V	C3-A39/DC ... V
C3-A30X/DC ... V	C3-A38X/DC ... V	C3-A39X/DC ... V
C3-A30DX/DC ... V	C3-A38DX/DC ... V	C3-A39DX/DC ... V
C3-A30FX/DC ... V	C3-A38FX/DC ... V	C3-A39FX/DC ... V
C3-A30BX/UC ... V	C3-A38BX/UC ... V	C3-A39BX/UC ... V

"..." List Coil Voltage to complete Product References

#### Accessories

Socket	S3-B, S3-S, S3-PO, S3-M, S3-M0, S3-M1
Blanking Plug	SO-NP (BAG 10 PCS)



#### Connection diagram

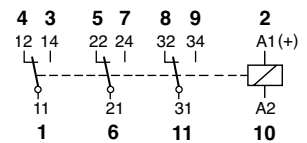


fig. 1 AC voltage endurance

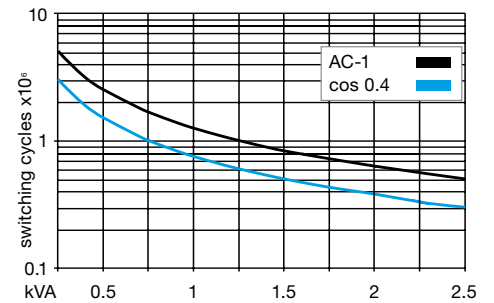
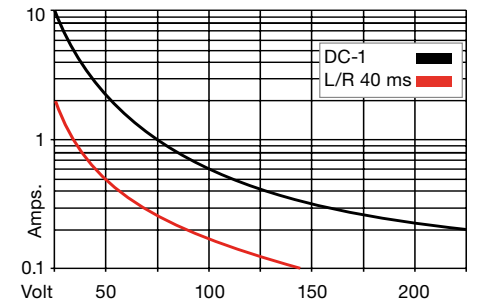
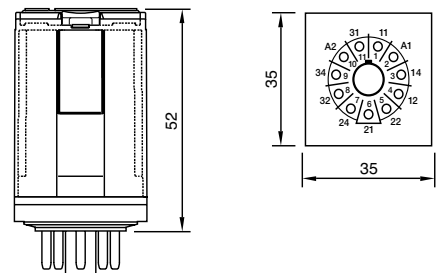


fig. 2 DC load limit curve



#### Dimensions (mm)



#### Technical approvals, conformities



IEC/EN 61810; IEC/EN 60947

### C3-T3x

#### 3 pole | changeover twin contact

<b>Maximum contact load</b>	<b>6 A/250 V</b>	<b>AC-1</b>	<b>6 A/30 V</b>	<b>DC-1</b>
<b>Recommended minimum contact load</b>	<b>5 mA/5 V</b>	<b>Code 1</b>		
	<b>1 mA/5 V</b>	<b>Code 2</b>		

#### Contacts

Material	Standard	Code 1	AgNi + 0.2 μ Au
	Optional	Code 2	AgNi + 5 μ Au
Rated Load			6 A
Max. inrush current (20 ms)			15 A
Switching voltage max.			250 V
AC load fig. 1			1.2 kVA
DC load			see fig. 2

#### Coil

Coil resistance	see table; tolerance ± 10 %
Pick-up voltage	≤ 0.8 × U <sub>N</sub>
Release voltage	≥ 0.1 × U <sub>N</sub>
Nominal power	2.2 VA (AC)/1.3 W (DC)

#### Coil table

V AC	Ω	mA	V DC	Ω	mA
24	67	92	24	480	50
48	296	46	48	1K8	26
115	1K7	19	110	9K	12
230	7K1	9.5	220	36K1	6

#### Insulation

Contact open	1000 V
Contact/contact	2.5 kV
Contact/coil	2.5 kV
Insulation resistance at 500 V	≥ 1 GΩ
Insulation, EN 61810-1	2.5 kV

#### Specifications

Ambient temperature operation/storage	-40 ... 70 °C / -40 ... 80 °C (no ice)
Pick-up time/bounce time	8 ms / ≤ 3 ms
Release time/bounce time	18 ms / ≤ 1 ms
Mechanical life ops	AC: 10 Mill./DC: 20 Mill.
DC voltage endurance at rated load	≥ 100 000 switching cycles
Max. switching frequency at rated load	1200/h
Weight	81 g

#### Product References

V AC 50 Hz/60 Hz: 24, 48, 115 (120), 230 (240)

LED

RC Suppressor

V DC 24, 48, 110, 220

LED

Free wheeling diode

Polarity and free wheeling diode

AC/DC bridge rectifier 24 V, 48 V, 60 V

Other voltages on request

C3-T31/AC ... V  
C3-T31X/AC ... V  
C3-T31R/AC ... V

C3-T32/AC ... V  
C3-T32X/AC ... V  
C3-T32R/AC ... V

C3-T31/DC ... V  
C3-T31X/DC ... V  
C3-T31DX/DC ... V  
C3-T31FX/DC ... V

C3-T32/DC ... V  
C3-T32X/DC ... V  
C3-T32DX/DC ... V  
C3-T32FX/DC ... V

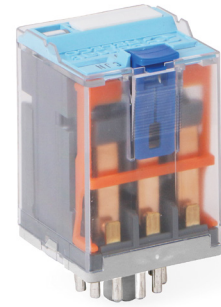
C3-T31BX/UC ... V

C3-T32BX/UC ... V

"..." List Coil Voltage to complete Product References

#### Accessories

Socket	S3-B, S3-S, S3-PO, S3-M, S3-M0, S3-M1
Blanking Plug	SO-NP (BAG 10 PCS)



#### Connection diagram

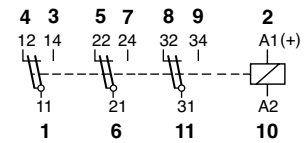


fig. 1 AC voltage endurance

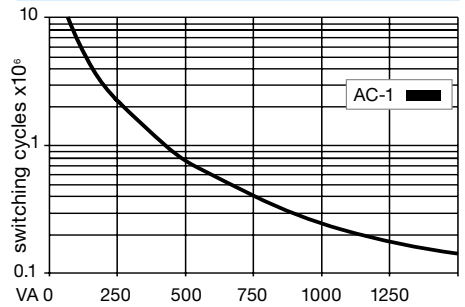
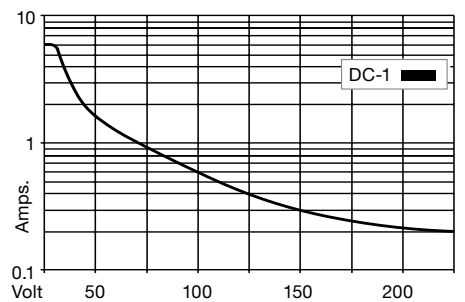
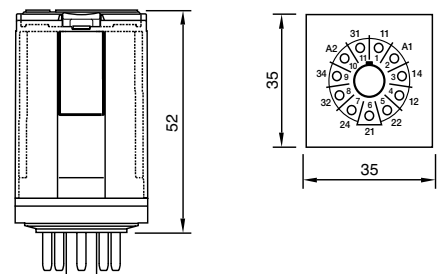


fig. 2 DC load limit curve



#### Dimensions (mm)



#### Technical approvals, conformities



IEC/EN 61810; IEC/EN 60947

### C3-G3x

#### 3 pole | normally open contact

<b>Maximum contact load</b>	<b>10 A/250 V AC-1</b>	<b>1.2 A/110 V DC-1</b>
<b>Recommended minimum contact load</b>	<b>10 A/30 V DC-1</b>	<b>0.4 A/220 V DC-1</b>

#### Contacts

Material	Standard	Code 0	⚡ AgNi
Rated Load			10 A
Max. inrush current (20 ms)			30 A
Switching voltage max.			250 V
AC load fig. 1			2.5 kVA
DC load			see fig. 2

#### Coil

Coil resistance	see table; tolerance ± 10 %
Pick-up voltage	≤ 0.8 × U <sub>N</sub>
Release voltage	≥ 0.1 × U <sub>N</sub>
Nominal power	2.4 VA (AC)/1.6 W (DC)

#### Coil table

V AC	Ω	mA	V DC	Ω	mA
24	65	100	24	360	66
48	286	50	48	1K4	34
115	1K7	21	110	7K6	15
230	6K8	10	220	30K3	7.5

#### Insulation

Contact open	2000 V
Contact/contact	2.5 kV
Contact/coil	2.5 kV
Insulation resistance at 500 V	≥ 1 GΩ
Insulation, IEC 61810-1	2.5 kV

#### Specifications

Ambient temperature operation/storage	-40...60 °C / -40 ... 80 °C (no ice)
Pick-up time/bounce time	20 ms / ≤ 3 ms
Release time/bounce time	8 ms / ≤ 1 ms
Mechanical life ops	AC: 10 Mill./DC: 20 Mill.
DC voltage endurance at rated load	≥ 100 000 switching cycles
Max. switching frequency at rated load	1200/h
Weight	81 g

#### Product References

V AC 50 Hz/60 Hz: 24, 48, 115 (120), 230 (240)

LED

RC Suppressor

V DC 24, 48, 110, 220

LED

Free wheeling diode

Polarity and free wheeling diode

AC/DC bridge rectifier 24 V, 48 V, 60 V

Other voltages on request

C3-G30/AC ... V

C3-G30X/AC ... V

C3-G30R/AC ... V

C3-G30/DC ... V

C3-G30X/DC ... V

C3-G30DX/DC... V

C3-G30FX/DC ... V

C3-G30BX/UC ... V

"..." List Coil Voltage to complete Product References

#### Accessories

Socket

S3-B, S3-S, S3-PO, S3-M, S3-M0, S3-M1

Blanking Plug

SO-NP (BAG 10 PCS)



#### Connection diagram

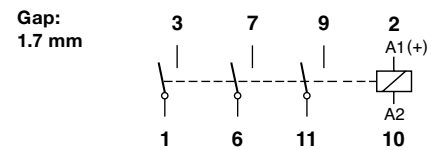


fig. 1 AC voltage endurance

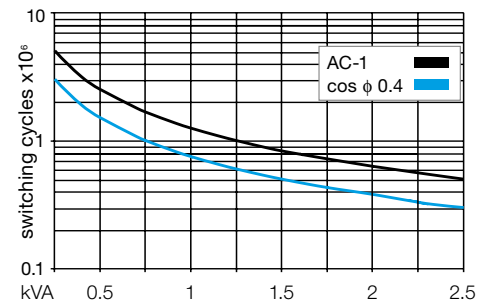
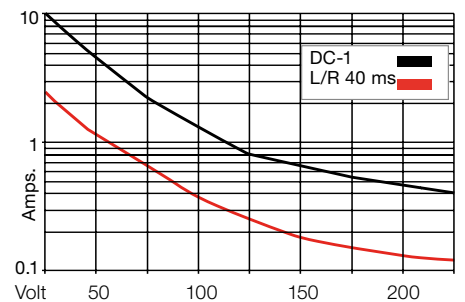
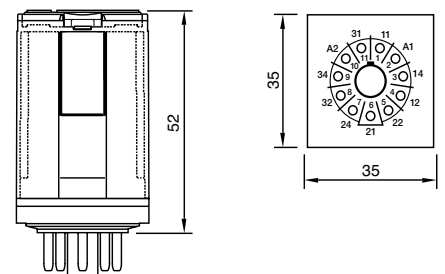


fig. 2 DC load limit curve



#### Dimensions (mm)



#### Technical approvals, conformities



IEC/EN 61810; IEC/EN 60947

### C3-M1x

#### 1 pole | normally open serial contact with blow magnet

**Maximum contact load** 10 A /250 V AC-1 10 A/220 V DC-1

#### Contacts

Material	Standard	Code 0	⚡ AgNi
Rated Load			10 A
Max. inrush current (20 ms)			30 A
Switching voltage max.			250 V
AC load fig. 1			2.5 kVA
DC load			see fig. 2

#### Coil

Coil resistance	see table; tolerance ± 10 %
Pick-up voltage	≤ 0.8 × U <sub>N</sub>
Release voltage	≥ 0.1 × U <sub>N</sub>
Nominal power	2.4 VA (AC) / 1.3 W (DC)

#### Coil table

V AC	Ω	mA	V DC	Ω	mA
24	65	100	24	480	50
48	286	50	48	1K8	26
115	1K7	21	110	9K	12
230	6K8	10	220	29K	7.5

#### Insulation

Contact open	2500 V
Contact/contact	2.5 kV
Contact/coil	2.5 kV
Insulation resistance at 500 V	≥ 1 G.Ω
Insulation, IEC 61810-1:	2.5 kV

#### Specifications

Ambient temperature operation/storage	-40 ... 70 °C (55° C AC) / -40 ... 80 °C (no ice)
Pick-up time/bounce time	20 ms / ≤ 3 ms
Release time/bounce time	10 ms / ≤ 1 ms
Mechanical life ops	AC: 10 Mill./DC: 20 Mill.
DC voltage endurance at rated load	≥ 100 000 switching cycles
Max. switching frequency at rated load	1200/h
Weight	90 g

#### Product References

V AC 50 Hz/60 Hz: 24, 48, 115 (120), 230 (240)

LED

RC Suppressor

V DC 24, 48, 110, 220

LED

Free wheeling diode

Polarity and free wheeling diode

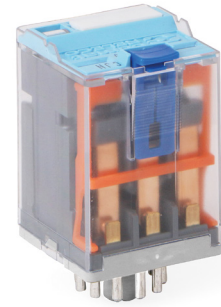
AC/DC bridge rectifier 24 V, 48 V, 60 V

Other voltages on request

"..." List Coil Voltage to complete Product References

#### Accessories

Socket	S3-B, S3-S, S3-PO, S3-M, S3-M0, S3-M1
Blanking Plug	SO-NP (BAG 10 PCS)



#### Connection diagram

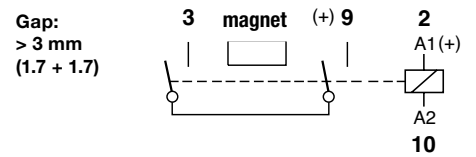


fig. 1 AC voltage endurance

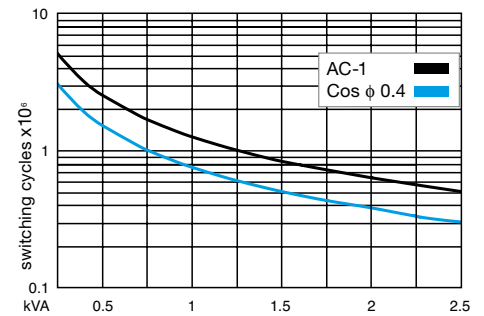
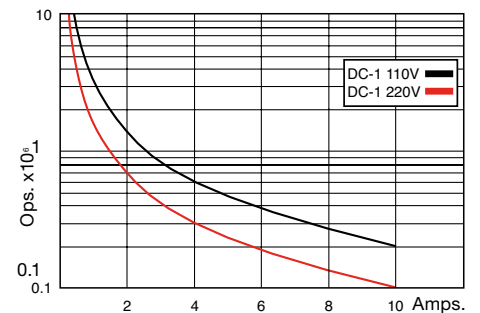
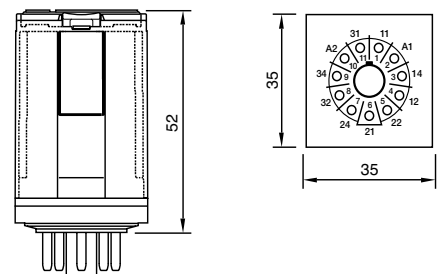


fig. 2 DC voltage endurance



#### Dimensions (mm)



#### Technical approvals, conformities



IEC/EN 61810; IEC/EN 60947



# C3-X1x

## 1 pole | normally open serial contact

<b>Maximum contact load</b>	<b>10 A/250 V AC-1</b>	<b>7 A/110 V DC-1</b>
	<b>10 A/30 V DC-1</b>	<b>1.2 A/220 V DC-1</b>

### Contacts

Material	Standard	Code 0	⚡ AgNi
Rated Load			10 A
Max. inrush current (20 ms)			30 A
Switching voltage max.			250 V
AC load fig. 1			2.5 kVA
DC load			see fig. 2

### Coil

Coil resistance	see table; tolerance ± 10 %
Pick-up voltage	≤ 0.8 × U <sub>N</sub>
Release voltage	≥ 0.1 × U <sub>N</sub>
Nominal power	2.4 VA (AC)/1.3 W (DC)

### Coil table

V AC	Ω	mA	V DC	Ω	mA
24	65	100	24	480	54
48	286	50	48	1K8	26
115	1K7	21	110	9K	12
230	6K8	10	220	29K	7.5

### Insulation

Contact open	2500 V
Contact/contact	2.5 kV
Contact/coil	2.5 kV
Insulation resistance at 500 V	≥ 1 GΩ
Insulation, IEC 61810-1	2.5 kV

### Specifications

Ambient temperature operation/storage	-40...60 °C / -40 ... 80 °C (no ice)
Pick-up time/bounce time	18 ms / ≤ 3 ms
Release time/bounce time	8 ms / ≤ 1 ms
Mechanical life ops	AC: 10 Mill./DC: 20 Mill.
DC voltage endurance at rated load	≥ 100 000 switching cycles
Max. switching frequency at rated load	1200/h
Weight	83 g

### Product References

V AC 50 Hz/60 Hz: 24, 48, 115 (120), 230 (240)

LED

RC Suppressor

V DC 24, 48, 110, 220

LED

Free wheeling diode

Polarity and free wheeling diode

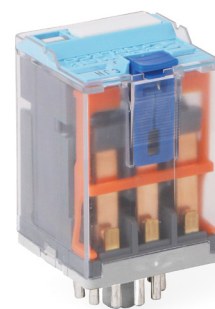
AC/DC bridge rectifier 24 V, 48 V, 60 V

Other voltages on request

"..." List Coil Voltage to complete Product References

### Accessories

Socket	<b>S3-B, S3-S, S3-PO, S3-M, S3-M0, S3-M1</b>
Blanking Plug	<b>SO-NP (BAG 10 PCS)</b>



### Connection diagram

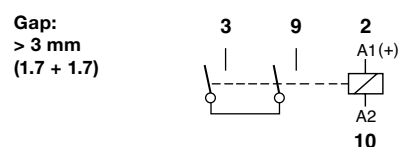


fig. 1 AC voltage endurance

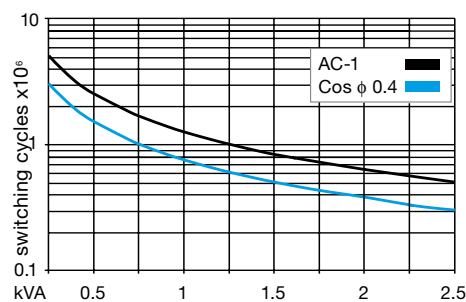
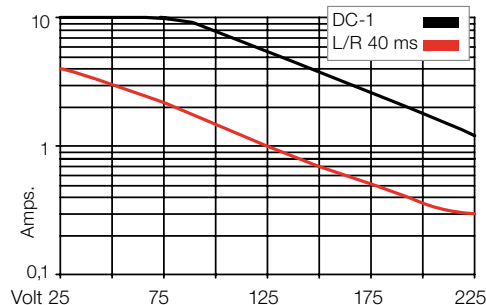
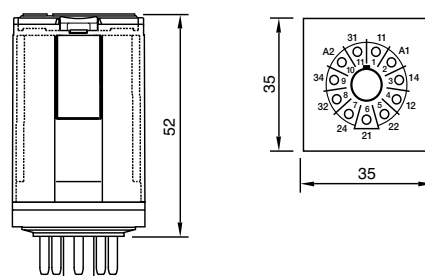


fig. 2 DC load limit curve



### Dimensions (mm)



### Technical approvals, conformities



IEC/EN 61810; IEC/EN 60947

# C3-R2x

2 pole | changeover contact | remanance



<b>Maximum contact load</b>	<b>10 A/250 V AC-1</b>	<b>0.5 A/110 V DC-1</b>
	<b>10 A/30 V DC-1</b>	<b>0.2 A/220 V DC-1</b>
<b>Recommended minimum contact load</b>	<b>10 mA/10 V Code 0</b>	
	<b>5 mA/5 V Code 8</b>	

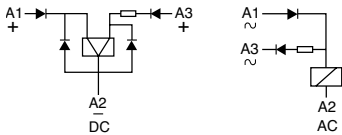
### Contacts

Material	Standard	Code 0	⚡ AgNi
	Optional	Code 8	⚡ AgNi + 5 μ Au
Rated Load	10 A		
Max. inrush current (20 ms)	30 A		
Switching voltage max.	250 V		
AC load fig. 1	2.5 kVA		
DC load	see fig. 2		

### Coil

Coil resistance	see table; tolerance ± 10 %
ON pulse power	1.5 VA/W
OFF pulse power	0.5 VA/W
Pull-in ON OFF	≤ 0.8 x U <sub>N</sub>

### Internal Diagram:



### Coil table

V AC	mA ON	mA OFF	V DC	mA ON	mA OFF
24	75	12	12	125	41
48	38	6	24	63	21
115	16	2.5	48	31	10
230	8	1.3	110	14	4.5

### Insulation

Contact open	1000 V
Contact/contact	2.5 kV
Contact/coil	2.5 kV
Insulation resistance at 500 V	≥ 1 GΩ
Insulation, IEC 61810-1	2.5 kV

### Specifications

Ambient temperature operation/storage	-40...60 °C / -40 ... 80 °C (no ice)
Minimum pulse length for ON OFF	50 ms
Mechanical life ops	10 Mill.
DC voltage endurance at rated load	≥ 100 000 switching cycles
Max. switching frequency at rated load	1200/h
Weight	81 g

### Product References

**V AC 50 Hz/60 Hz: 24, 48, 115, 230**

**C3-R20N/AC ... V C3-R28N/AC ... V**

**V DC 12, 24, 48, 110**

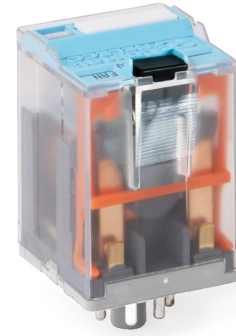
**C3-R20N/DC ... V C3-R28N/DC ... V**

Other voltages on request

"..."List Coil Voltage to complete Product References

### Accessories

Socket	<b>S3-B, S3-S, S3-PO, S3-M, S3-M0, S3-M1</b>
Blanking Plug	<b>SO-NP (BAG 10 PCS)</b>



### Connection diagram

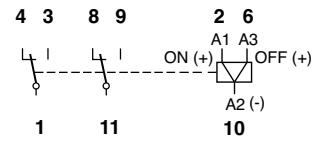


fig. 1 AC voltage endurance

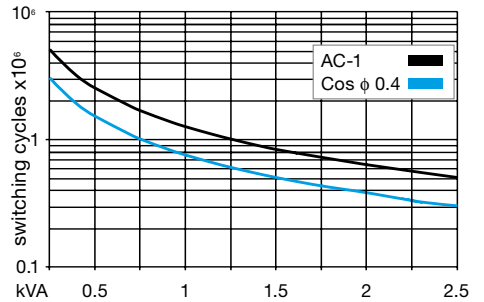
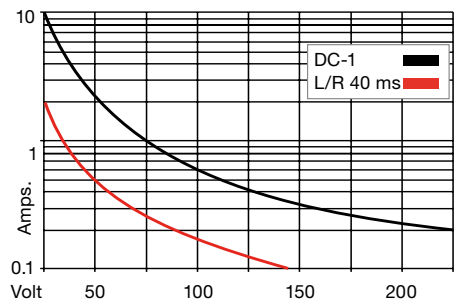
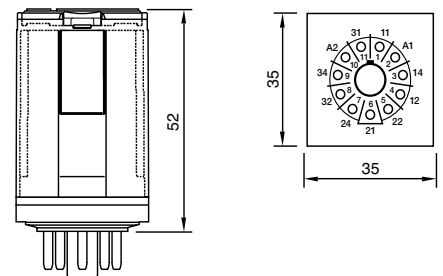


fig. 2 DC load limit curve



### Dimensions (mm)



### Technical approvals, conformities



IEC/EN 61810; IEC/EN 60947

### C3-N3x

#### 3 pole | changeover contact | sensitive coil

<b>Maximum contact load</b>	<b>6 A/250 V</b>	<b>AC-1</b>	<b>6 A/30 V</b>	<b>DC-1</b>
<b>Recommended minimum contact load</b>	<b>10 mA/10 V</b>	<b>Code 4</b>		
	<b>5 mA/5 V</b>	<b>Code 8</b>		

#### Contacts

Material	Standard	Code 4	AgNi + 0.2 μ Au
	Optional	Code 8	AgNi + 5 μ Au
Rated Load			5 A
Max. inrush current (20 ms)			30 A
Switching voltage max.			250 V
AC load fig. 1			1.5 kVA
DC load			see fig. 2

#### Coil

Coil resistance	see table; tolerance ± 10 %
Pick-up voltage	≤ 0.8 x U <sub>n</sub>
Release voltage	≥ 0.1 x U <sub>n</sub>
Nominal power	800 mW

#### Coil table

V AC	Ω	mA	V DC	Ω	mA
24	67	92	24	480	50
48	296	46	48	1K8	26
115	1K7	19	110	9K	12
230	7K1	9.5	220	36K1	6

#### Insulation

Contact open	1000 V
Contact/contact	2.5 kV
Contact/coil	2.5 kV
Insulation resistance at 500 V	≥ 1 G.Ω
Insulation, IEC 61810-1	2.5 kV

#### Specifications

Ambient temperature operation/storage	-40...60 °C / -40 ... 80 °C (no ice)
Pick-up time/bounce time	18 ms / ≤ 3 ms
Release time/bounce time	10 ms / ≤ 1 ms
Mechanical life ops	DC: 20 Mill.
DC voltage endurance at rated load	≥ 100 000 switching cycles
Max. switching frequency at rated load	1200/h
Weight	90 g

#### Product References

V DC 24, 48, 60, 110

Free wheeling diode

Polarity and free wheeling diode

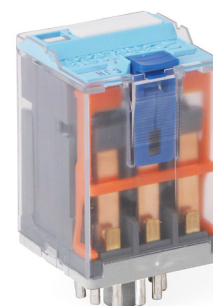
Other voltages on request

C3-N34/DC ... V	C3-N38/DC ... V
C3-N34D/DC ... V	C3-N38D/DC ... V
C3-N34F/DC ... V	C3-N38F/DC ... V

"..." List Coil Voltage to complete Product References

#### Accessories

Socket	<b>S3-B, S3-S, S3-PO, S3-M, S3-M0, S3-M1</b>
Blanking Plug	<b>SO-NP (BAG 10 PCS)</b>



#### Connection diagram

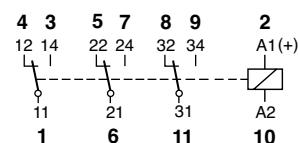


fig. 1 AC voltage endurance

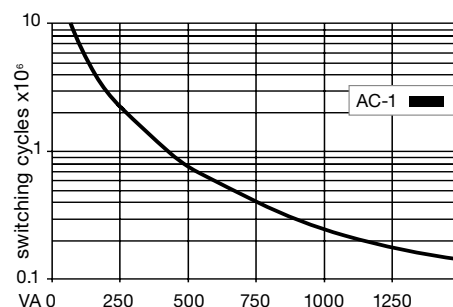
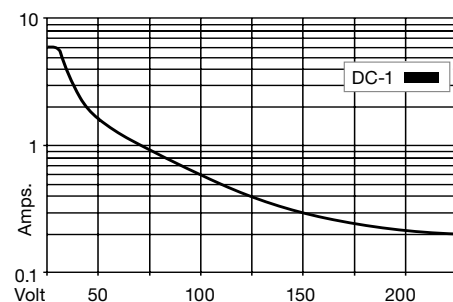
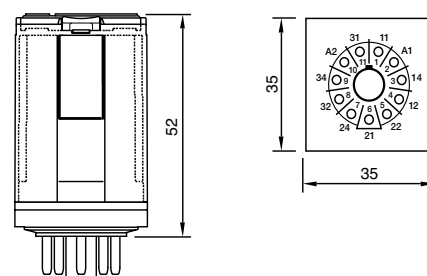


fig. 2 DC load limit curve



#### Dimensions (mm)



#### Technical approvals, conformities



IEC/EN 61810; IEC/EN 60947

# C4-A4x

## 4 pole | changeover contact | Faston

<b>Maximum contact load</b>	<b>10 A/250 V</b>	<b>AC-1</b>	<b>0.5 A/110 V</b>	<b>DC-1</b>
	<b>10 A/30 V</b>	<b>DC-1</b>	<b>0.2 A/220 V</b>	<b>DC-1</b>
<b>Recommended minimum contact load</b>	<b>10 mA/5 V</b>	<b>Code 0</b>		
	<b>5 mA/5 V</b>	<b>Code 8</b>		

### Contacts

Material	Standard	Code 0	⚡ AgNi
	Optional	Code 8	⚡ AgNi + 5 μ Au
Rated Load			10 A
Max. inrush current (20 ms)			30 A
Switching voltage max.			250 V
AC load fig. 1			2.5 kVA
DC load			see fig. 2

### Coil

Coil resistance	see table; tolerance ± 10 %
Pick-up voltage	≤ 0.8 × U <sub>N</sub>
Release voltage	≥ 0.1 × U <sub>N</sub>
Nominal power	2.4 VA (AC)/1.4 W (DC)

### Coil table

V AC	Ω	mA	V DC	Ω	mA
24	65	100	24	414	58
48	286	50	48	1K6	30
115	1K7	21	110	8K1	13
-	-	-	120-125	10K	12.3
230	6K8	10	220	35K7	6.2

### Insulation

Contact open	1000 V
Contact/contact	2.5 kV
Contact/coil	2.5 kV
Insulation resistance at 500 V	≥ 1 GΩ
Insulation, IEC 61810-1	2.5 kV

### Specifications

Ambient temperature operation/storage	-40...60 °C / -40 ... 80 °C (no ice)
Pick-up time/bounce time	20 ms / ≤ 3 ms
Release time/bounce time	8 ms / ≤ 1 ms
Mechanical life ops	AC: 10 Mill./DC: 20 Mill.
DC voltage endurance at rated load	≥ 100 000 switching cycles
Max. switching frequency at rated load	1200/h
Weight	90 g

### Product References

V AC 50 Hz/60 Hz: 24, 48, 115, (120), 230, (240)

LED

RC Suppressor

C4-A40/AC ... V

C4-A40X/AC ... V

C4-A40R/AC ... V

C4-A48/AC ... V

C4-A48X/AC ... V

C4-A48R/AC ... V

V DC 24, 48, 110, 220

LED

Free wheeling diode

Polarity and free wheeling diode

C4-A40/DC ... V

C4-A40X/DC ... V

C4-A40DX/DC ... V

C4-A40FX/DC ... V

C4-A48/DC ... V

C4-A48X/DC ... V

C4-A48DX/DC ... V

C4-A48FX/DC ... V

AC/DC bridge rectifier 24 V, 48 V, 60 V

Other voltages on request

C4-A40BX/UC ... V

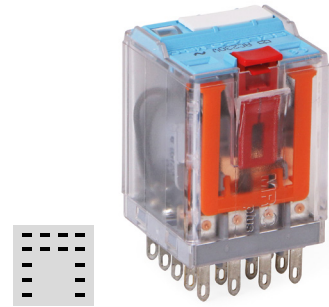
C4-A48BX/UC ... V

"..." List Coil Voltage to complete Product References

### Accessories

Socket  
Wall Mounting Adapter  
Blanking Plug

S4-J, S4-L, S4-P  
S5-R (BAG 5 PCS)  
SO-NP (BAG 10 PCS)



### Connection diagram

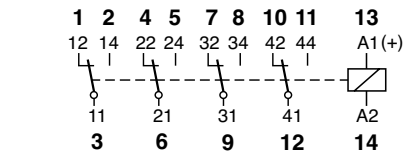


fig. 1 AC voltage endurance

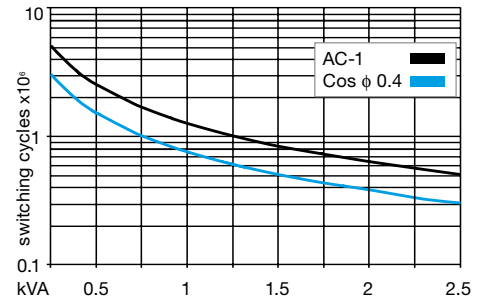
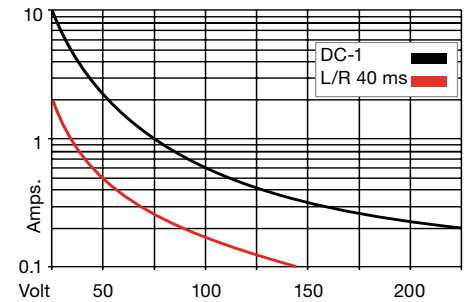
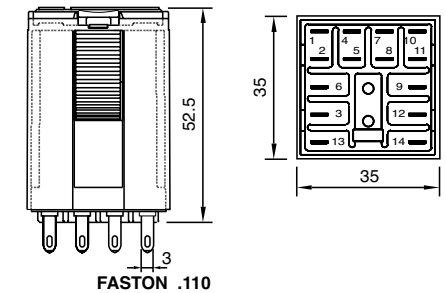


fig. 2 DC load limit curve



### Dimensions (mm)



### Technical approvals, conformities



## C4-X2x

2 pole | normally open serial contact | Faston

<b>Maximum contact load</b>	<b>10 A/250 V AC-1</b>	<b>7 A/110 V DC-1</b>
	<b>10 A/30 V DC-1</b>	<b>1.2 A/220 V DC-1</b>
<b>Recommended minimum contact load</b>	<b>10 mA/10 V Code 0</b>	

### Contacts

Material	Standard	Code 0	⚡ AgNi
Rated Load			10 A
Max. inrush current (20 ms)			30 A
Switching voltage max			250 V
AC load fig. 1			2.5 kVA
DC load			see fig. 2

### Coil

Coil resistance	see table; tolerance ± 10 %
Pick-up voltage	≤ 0.8 × U <sub>N</sub>
Release voltage	≥ 0.1 × U <sub>N</sub>
Nominal power	2.4 VA (AC)/1.3 W (DC)

### Coil table

V AC	Ω	mA	V DC	Ω	mA
24	65	100	24	443	54
48	286	50	48	1K8	27
115	1K7	21	110	9K2	12
230	6k8	10	220	30K3	6

### Insulation

Contact open	2500 V
Contact/contact	2.5 kV
Contact/coil	2.5 kV
Insulation resistance at 500 V	≥ 1 GΩ
Insulation, IEC 61810-1	2.5 kV

### Specifications

Ambient temperature operation/storage	-40...60 °C / -40 ... 80 °C (no ice)
Pick-up time/bounce time	20 ms / ≤ 3 ms
Release time/bounce time	8 ms / ≤ 1 ms
Mechanical life ops	AC: 10 Mill./DC: 20 Mill.
DC voltage endurance at rated load	≥ 100 000 switching cycles
Max. switching frequency at rated load	1200/h
Weight	90 g

### Product References

V AC 50 Hz/60 Hz: 24, 48, 115, (120), 230, (240)

LED

RC Suppressor

V DC 24, 48, 110, 220

LED

Free wheeling diode

Polarity and free wheeling diode

AC/DC bridge rectifier 24 V, 48 V, 60 V

Other voltages on request

C4-X20/AC ... V

C4-X20X/AC ... V

C4-X20R/AC ... V

C4-X20/DC ... V

C4-X20X/DC ... V

C4-X20DX/DC ... V

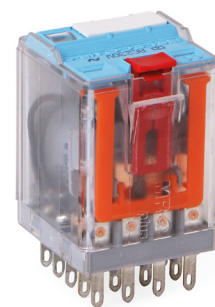
C4-X20FX/DC ... V

C4-X20BX/UC ... V

"..." List Coil Voltage to complete Product References

### Accessories

Socket	S4-J, S4-L, S4-P
Wall Mounting Adapter	S5-R (BAG 5 PCS)
Blanking Plug	SO-NP (BAG 10 PCS)



### Connection diagram

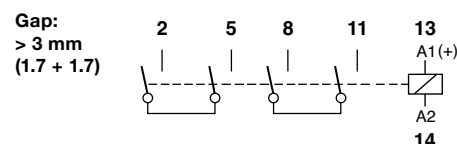


fig. 1 AC voltage endurance

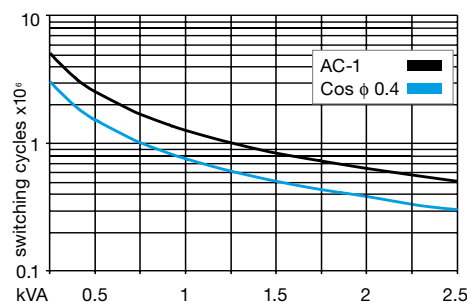
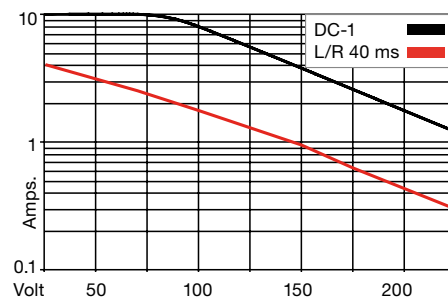
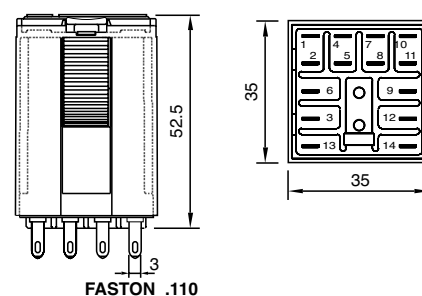


fig. 2 DC load limit curve



### Dimensions (mm)



### Technical approvals, conformities



IEC/EN 61810; IEC/EN 60947

### C4-R3x

3 pole | changeover contact | remanance

<b>Maximum contact load</b>	<b>10 A/250 V AC-1</b>	<b>0.5 A/110 V DC-1</b>
	<b>10 A/10 V DC-1</b>	<b>0.2 A/220 V DC-1</b>
<b>Recommended minimum contact load</b>	<b>10 mA/10 V Code 0</b>	
	<b>5 mA/5 V Code 8</b>	

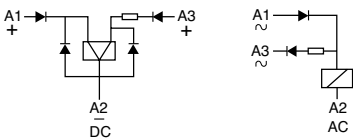
#### Contacts

Material	Standard	Code 0	⚡ AgNi
	Optional	Code 8	⚡ AgNi + 5 μ Au
Rated Load	10 A		
Max. inrush current (20 ms)	30 A		
Switching voltage max.	250 V		
AC load fig. 1	2.5 kVA		
DC load	see fig. 2		

#### Coil

Coil resistance	see table; tolerance ± 10 %
ON pulse power	1.5 VA/W
OFF pulse power	0.5 VA/W
Pull-in ON OFF	1 Winding for AC, 2 Windings for DC ≤ 0.8 × U <sub>N</sub>

#### Internal Diagram:



#### Coil table

V AC	mA ON	mA OFF	V DC	mA ON	mA OFF
24	75	12	12	125	41
48	38	6	24	63	21
115	16	2.5	48	31	10
230	8	1.3	110	14	4.5

#### Insulation

Contact open	1000 V
Contact/contact	2.5 kV
Contact/coil	2.5 kV
Insulation resistance at 500 V	≥1 G.Ω
Insulation, IEC 61810-1	2.5 kV

#### Specifications

Ambient temperature operation/storage	-40...60 °C / -40 ... 80 °C (no ice)
Minimum pulse length for ON OFF	50 ms
Mechanical life ops	AC: 10 Mill./DC: 20 Mill. switching cycles
DC voltage endurance at rated load	≥100 000 switching cycles
Max. switching frequency at rated load	1200/h
Weight	95 g

#### Product References

**V AC 50 Hz/60 Hz: 24, 48, 115, 230**

**C4-R30/AC ... V C4-R38/AC ... V**

**V DC 12, 24, 48, 110**

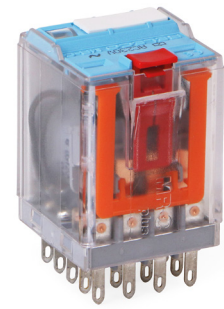
**C4-R30/DC ... V C4-R38/DC ... V**

Other voltages on request

"..." List Coil Voltage to complete Product References

#### Accessories

Socket	<b>S4-J, S4-L, S4-P</b>
Wall Mounting Adapter	<b>S5-R (BAG 5 PCS)</b>
Blanking Plug	<b>SO-NP (BAG 10 PCS)</b>



#### Connection diagram

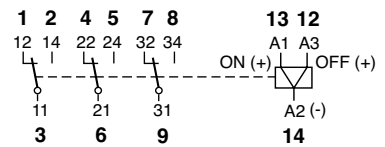


fig. 1 AC voltage endurance

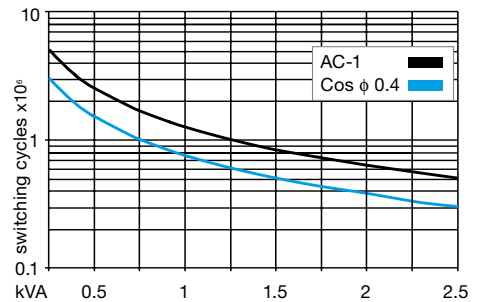
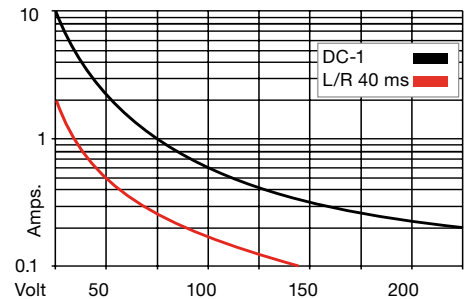
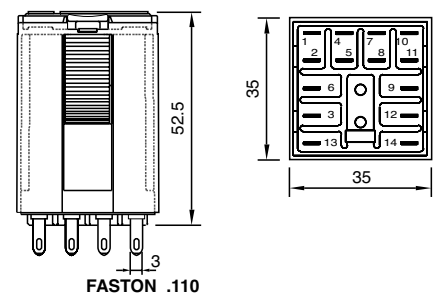


fig. 2 DC load limit curve



#### Dimensions (mm)



#### Technical approvals, conformities



IEC/EN 61810; IEC/EN 60947

## C5-A2x

2 pole | changeover contact | Faston

<b>Maximum contact load</b>	<b>16 A/400 V AC-1</b>	<b>0.5 A/110 V DC-1</b>
	<b>16 A/30 V DC-1</b>	<b>0.2 A/220 V DC-1</b>
<b>Recommended minimum contact load</b>	<b>10mA/10V</b>	

### Contacts

Material	Standard	Code 0	⚡ AgNi
Rated Load			16 A
Max. inrush current (20 ms)			40 A
Switching voltage max.			400 V
AC load fig. 1			4 kVA
DC load			see fig. 2

### Coil

Coil resistance	see table; tolerance ± 10 %
Pick-up voltage	≤ 0.8 × U <sub>n</sub>
Release voltage	≥ 0.1 × U <sub>n</sub>
Nominal power	2.4 VA (AC)/1.4 W (DC)

### Coil table

V AC	Ω	mA	V DC	Ω	mA
24	65	100	24	414	58
48	286	50	48	1K6	30
115	1K7	21	110	8K1	13
230	6K8	10	220	30K3	6
400	18K8	6			

### Insulation

Contact open	1000 V
Contact/contact	4 kV
Contact/coil	4 kV
Insulation resistance at 500 V	≥3 GΩ
Insulation, IEC 61810-1	4 kV

### Specifications

Ambient temperature operation/storage	-40...60 °C / -40 ... 80 °C (no ice)
Pick-up time/bounce time	20 ms / ≤ 3 ms
Release time/bounce time	10 ms / ≤ 1 ms
Mechanical life ops	AC: 10 Mill./DC: 20 Mill.
DC voltage endurance at rated load	≥100 000 switching cycles
Max. switching frequency at rated load	1200/h
Weight	90 g

### Product References

V AC 50 Hz/60 Hz: 24, 48, 115 (120), 230 (240)

LED

RC Suppressor (max 250 V)

V DC 24, 48, 110, 220

LED

Free wheeling diode

Polarity and free wheeling diode

AC/DC bridge rectifier 24 V, 48 V, 60 V

Other voltages on request

C5-A20/AC ... V

C5-A20X/AC ... V

C5-A20R/AC ... V

C5-A20/DC ... V

C5-A20X/DC ... V

C5-A20DX/DC ... V

C5-A20FX/DC ... V

C5-A20BX/UC ... V

"..." List Coil Voltage to complete Product References

### Accessories

Socket	S5-M, S5-P
Wall Mounting Adapter	S5-R (BAG 5 PCS)
Blanking Plug	SO-NP (BAG 10 PCS)



### Connection diagram

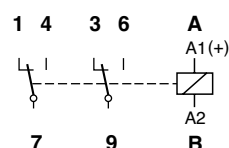


fig. 1 AC voltage endurance

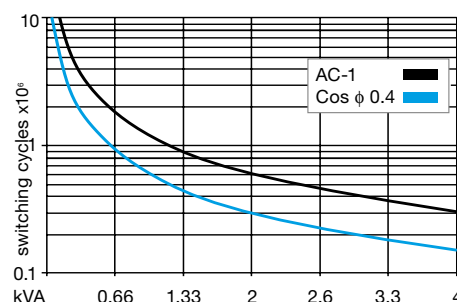
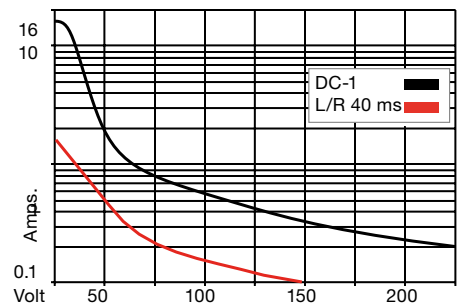
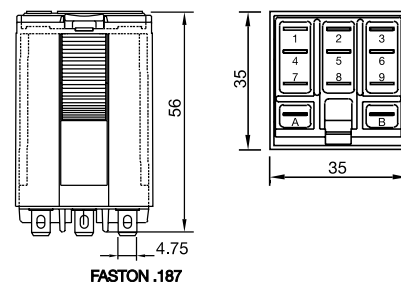


fig. 2 DC load limit curve



### Dimensions (mm)



### Technical approvals, conformities



IEC/EN 61810; IEC/EN 60947

**C5-A3x**

**3 pole | changeover contact | Faston**



<b>Maximum contact load</b>	<b>16 A/400 V AC-1</b>	<b>0.5 A/110 V DC-1</b>
	<b>16 A/30 V DC-1</b>	<b>0.2 A/220 V DC-1</b>
<b>Recommended minimum contact load</b>	<b>10mA/10V</b>	

**Contacts**

Material	Standard	Code 0	AgNi
	Optional	Code 5	AgSnO <sub>2</sub>
Rated Load	16 A		
Max. inrush current (20 ms)	40 A		
Switching voltage max.	400 V		
AC load fig. 1	4 kVA		
DC load	see fig. 2		

**Coil**

Coil resistance	see table; tolerance ± 10 %
Pick-up voltage	≤ 0.8 x U <sub>N</sub>
Release voltage	≥ 0.1 x U <sub>N</sub>
Nominal power	2.4 VA (AC)/1.4 W (DC)

**Coil table**

V AC	Ω	mA	V DC	Ω	mA
24	65	100	24	414	58
48	286	50	48	1K6	30
115	1K7	21	110	8K1	13
230	6K8	10	220	30K3	6.2
400	18K8	6			

**Insulation**

Contact open	1000 V
Contact/contact	4 kV
Contact/coil	4 kV
Insulation resistance at 500 V	≥3 GΩ
Insulation, IEC 61810-1	4 kV

**Specifications**

Ambient temperature operation/storage	-40...60 °C /-40 ... 80 °C (no ice)
Pick-up time/bounce time	20 ms /≤ 3 ms
Release time/bounce time	10 ms /≤ 1 ms
Mechanical life ops	AC: 10 Mill./DC: 20 Mill.
DC voltage endurance at rated load	≥100 000 switching cycles
Max. switching frequency at rated load	1200/h
Weight	95 g

**Product References**

**V AC 50 Hz/60 Hz: 24, 48, 115, (120), 230, (240)**

**LED**

**RC Suppressor (max 250 V)**

**C5-A30/AC ... V**

**C5-A30X/AC ... V**

**C5-A30R/AC ... V**

**C5-A35/AC ... V**

**C5-A35X/AC ... V**

**C5-A35R/AC ... V**

**V DC 24, 48, 110, 220**

**LED**

**Free wheeling diode**

**Polarity and free wheeling diode**

**C5-A30/DC ... V**

**C5-A30X/DC ... V**

**C5-A30DX/DC ... V**

**C5-A30FX/DC ... V**

**C5-A35/DC ... V**

**C5-A35X/DC ... V**

**C5-A35DX/DC ... V**

**C5-A35FX/DC ... V**

**AC/DC bridge rectifier 24 V, 48 V, 60 V**

Other voltages on request

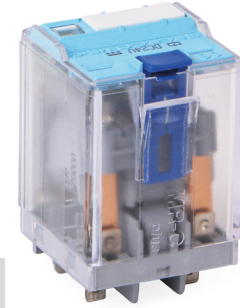
**C5-A30BX/UC ... V**

**C5-A35BX/UC ... V**

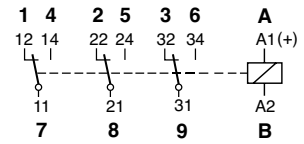
"..." List Coil Voltage to complete Product References

**Accessories**

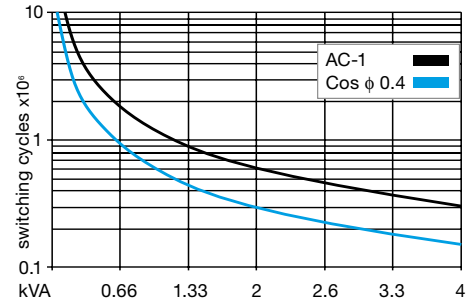
Socket	<b>S5-M, S5-P</b>
Wall Mounting Adapter	<b>S5-R (BAG 5 PCS)</b>
Blanking Plug	<b>SO-NP (BAG 10 PCS)</b>



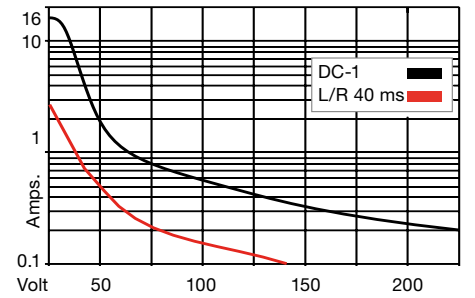
**Connection diagram**



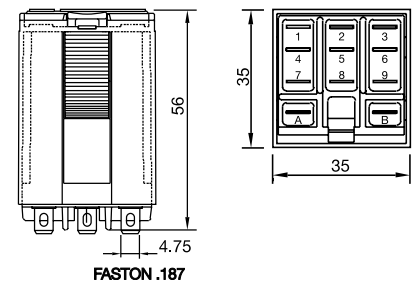
**fig. 1 AC voltage endurance**



**fig. 2 DC load limit curve**



**Dimensions (mm)**



**Technical approvals, conformities**



IEC/EN 61810; IEC/EN 60947



## C5-G3x

3 pole | normally open contact | Faston

<b>Maximum contact load</b>	<b>16 A/400 V AC-1</b>	<b>1.2 A/110 V DC-1</b>
	<b>16 A/30 V DC-1</b>	<b>0.4 A/220 V DC-1</b>
<b>Recommended minimum contact load</b>	<b>10mA/10V</b>	

### Contacts

Material	Standard	Code 0	⚡ AgNi
	Optional	Code 5	⚡ AgSnO <sub>2</sub>
Rated Load	16 A		
Max. inrush current (20 ms)	40 A		
Switching voltage max.	400 V		
AC load fig. 1	4 kVA		
DC load	see fig. 2		

### Coil

Coil resistance	see table; tolerance ± 10 %
Pick-up voltage	≤ 0.8 × U <sub>n</sub>
Release voltage	≥ 0.1 × U <sub>n</sub>
Nominal power	2.4 VA (AC)/1.6 W (DC)

### Coil table

V AC	Ω	mA	V DC	Ω	mA
24	65	100	12	90	133
48	286	50	24	373	66
115	1K7	21	48	1K4	34
230	6K8	10	110	7K6	15
400	18K8	6	220	30K3	7.5

### Insulation

Contact open	2000 V
Contact/contact	4 kV
Contact/coil	4 kV
Insulation resistance at 500 V	≥ 3 GΩ
Insulation, IEC 61810-1	4 kV

### Specifications

Ambient temperature operation/storage	-40...60 °C / -40 ... 80 °C (no ice)
Pick-up time/bounce time	20 ms / ≤ 3 ms
Release time/bounce time	10 ms / ≤ 1 ms
Mechanical life ops	AC: 10 Mill./DC: 20 Mill.
DC voltage endurance at rated load	≥ 100 000 switching cycles
Max. switching frequency at rated load	1200/h
Weight	95 g

### Product References

<b>V AC 50 Hz/60 Hz: 24, 48, 115, (120), 230, (240)</b>	<b>C5-G30/AC ... V</b>	<b>C5-G35/AC ... V</b>
<b>LED</b>	<b>C5-G30X/AC ... V</b>	<b>C5-G35X/AC ... V</b>
<b>RC Suppressor (max 250 V)</b>	<b>C5-G30R/AC ... V</b>	<b>C5-G35R/AC ... V</b>
<b>V DC 12, 24, 48, 110, 220</b>	<b>C5-G30/DC ... V</b>	<b>C5-G35/DC ... V</b>
<b>LED</b>	<b>C5-G30X/DC ... V</b>	<b>C5-G35X/DC ... V</b>
<b>Free wheeling diode</b>	<b>C5-G30DX/DC ... V</b>	<b>C5-G35DX/DC ... V</b>
<b>Polarity and free wheeling diode</b>	<b>C5-G30FX/DC ... V</b>	<b>C5-G35FX/DC ... V</b>
<b>AC/DC bridge rectifier 24 V, 48 V, 60 V</b>	<b>C5-G30BX/UC ... V</b>	<b>C5-G35BX/UC ... V</b>

Other voltages on request

"..." List Coil Voltage to complete Product References

### Accessories

Socket	<b>S5-M, S5-P</b>
Wall Mounting Adapter	<b>S5-R (BAG 5 PCS)</b>
Blanking Plug	<b>SO-NP (BAG 10 PCS)</b>



### Connection diagram

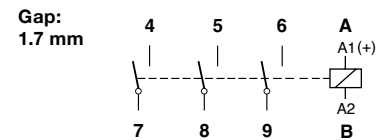


fig. 1 AC voltage endurance

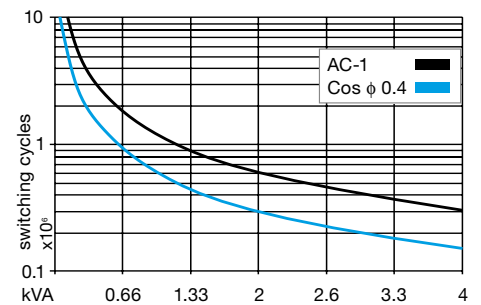
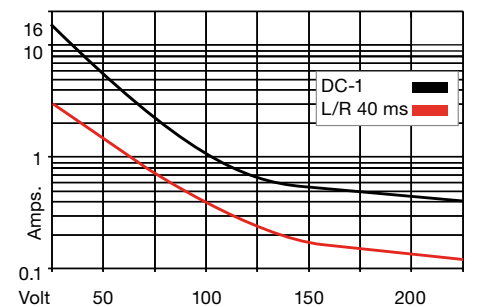
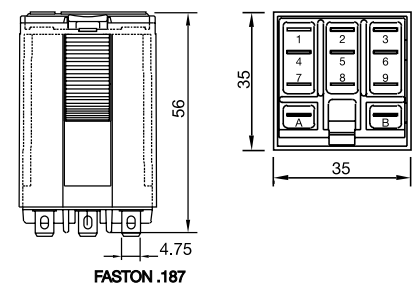


fig. 2 DC load limit curve



### Dimensions (mm)



### Technical approvals, conformities



IEC/EN 61810; IEC/EN 60947

### C5-X1x

1 pole | normally open serial contact | Faston

<b>Maximum contact load</b>	<b>16 A/400 V AC-1</b>	<b>7 A/110 V DC-1</b>
	<b>16 A/30 V DC-1</b>	<b>1.2 A/220V DC-13</b>
<b>Recommended minimum contact load</b>	<b>10mA/10V</b>	

**Contacts**

Material	Standard	Code 0	⚡ AgNi
Rated Load			16 A
Max. inrush current (20 ms)			40 A
Switching voltage max.			400 V
AC load fig. 1			4 kVA
DC load			see fig. 2

**Coil**

Coil resistance	see table; tolerance ± 10 %
Pick-up voltage	≤ 0.8 × U <sub>N</sub>
Release voltage	≥ 0.1 × U <sub>N</sub>
Nominal power	2.4 VA (AC)/1.3 W (DC)

**Coil table**

V AC	Ω	mA	V DC	Ω	mA
24	65	100	12	110	108
48	286	50	24	443	54
115	1K7	21	48	1K7	27
230	6K8	10	110	9K2	12
400	18K8	6	220	30K3	6.2

**Insulation**

Contact open	4 kV
Contact/contact	4 kV
Contact/coil	4 kV
Insulation resistance at 500 V	≥ 3 GΩ
Insulation, IEC 61810-1	4 kV

**Specifications**

Ambient temperature operation/storage	-40...60 °C / -40 ... 80 °C (no ice)
Pick-up time/bounce time	20 ms / ≤ 3 ms
Release time/bounce time	10 ms / ≤ 1 ms
Mechanical life ops	AC: 10 Mill./DC: 20 Mill.
DC voltage endurance at rated load	≥100 000 switching cycles
Max. switching frequency at rated load	1200/h
Weight	90 g

**Product References**

<b>V AC 50 Hz/60 Hz: 24, 48, 115 (120), 230 (240)</b>	<b>C5-X10/AC ... V</b>
<b>LED</b>	<b>C5-X10X/AC ... V</b>
<b>RC Suppressor (max 250 V)</b>	<b>C5-X10R/AC ... V</b>
<b>V DC 12, 24, 48, 110, 220</b>	<b>C5-X10/DC ... V</b>
<b>LED</b>	<b>C5-X10X/DC ... V</b>
<b>Free wheeling diode</b>	<b>C5-X10DX/DC ... V</b>
<b>Polarity and free wheeling diode</b>	<b>C5-X10FX/DC ... V</b>
<b>AC/DC bridge rectifier 24 V, 48 V, 60 V</b>	<b>C5-X10BX/UC ... V</b>

Other voltages on request

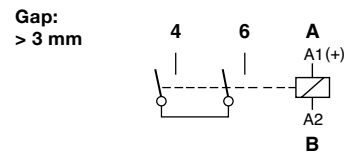
"..." List Coil Voltage to complete Product References

**Accessories**

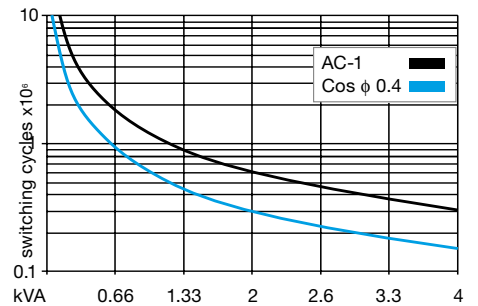
Socket	<b>S5-M, S5-P</b>
Wall Mounting Adapter	<b>S5-R (BAG 5 PCS)</b>
Blanking Plug	<b>SO-NP (BAG 10 PCS)</b>



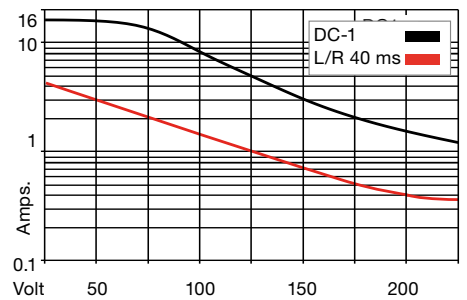
**Connection diagram**



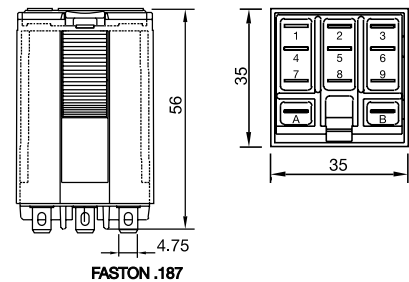
**fig. 1 AC voltage endurance**



**fig. 2 DC load limit curve**



**Dimensions (mm)**



**Technical approvals, conformities**



# C5-M1x

1 pole | normally open serial contact with blow magnet | Faston

<b>Maximum contact load</b>	<b>16 A/400 V AC-1</b>	<b>10 A/220 V DC-1</b>
	<b>3.6 A/110 V DC-13</b>	<b>2 A/220 V DC-13</b>
<b>Recommended minimum contact load</b>	<b>10mA/10V</b>	

### Contacts

Material	Standard	Code 0	⚡ AgNi
Rated Load			16 A
Max. inrush current (20 ms)			40 A
Switching voltage max.			400 V
AC load fig. 1			4 kVA
DC load			see fig. 2

### Coil

Coil resistance	see table; tolerance ± 10 %
Pick-up voltage	≤ 0.8 × U <sub>N</sub>
Release voltage	≥ 0.1 × U <sub>N</sub>
Nominal power	2.4 VA (AC)/1.3 W (DC)

### Coil table

V AC	Ω	mA	V DC	Ω	mA
24	65	100	12	110	108
48	286	50	24	443	54
115	1K7	21	48	1K7	27
230	6K8	10	110	9K2	12
400	18K8	6	220	30K3	6.2

### Insulation

Contact open	4000 V
Contact/contact	4 kV
Contact/coil	4 kV
Insulation resistance at 500 V	≥ 3 G.Ω
Insulation, IEC 61810-1	4 kV

### Specifications

Ambient temperature operation/storage	-40...60 °C / -40 ... 80 °C (no ice)
Pick-up time/bounce time	20 ms / ≤ 3 ms
Release time/bounce time	10 ms / ≤ 1 ms
Mechanical life ops	AC: 10 Mill./DC: 20 Mill.
DC voltage endurance	see fig. 2
Max. switching frequency at rated load	1200/h
Weight	90 g

### Product References

V AC 50 Hz/60 Hz: 24, 48, 115 (120), 230 (240)

LED

RC Suppressor (max 250 V)

V DC 12, 24, 48, 110, 220

LED

Free wheeling diode

Polarity and free wheeling diode

AC/DC bridge rectifier 24 V, 48 V, 60 V

Other voltages on request

C5-M10/AC ... V

C5-M10X/AC ... V

C5-M10R/AC ... V

C5-M10/DC ... V

C5-M10X/DC ... V

C5-M10DX/DC ... V

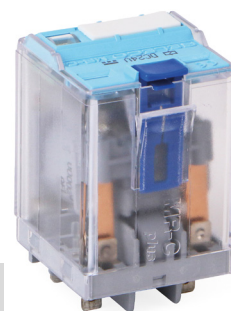
C5-M10FX/DC ... V

C5-M10BX/UC ... V

"..." List Coil Voltage to complete Product References

### Accessories

Socket	S5-M, S5-P
Wall Mounting Adapter	S5-R (BAG 5 PCS)
Blanking Plug	SO-NP (BAG 10 PCS)



### Connection diagram

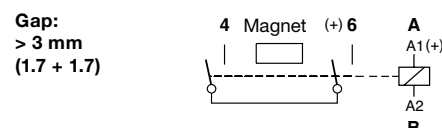


fig. 1 AC voltage endurance

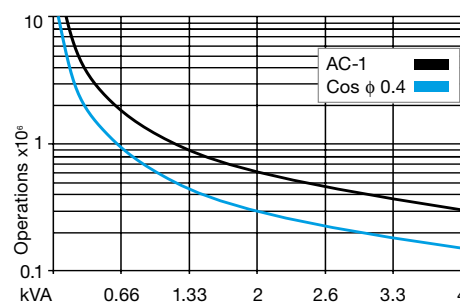
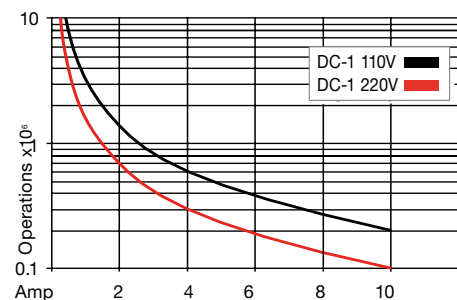
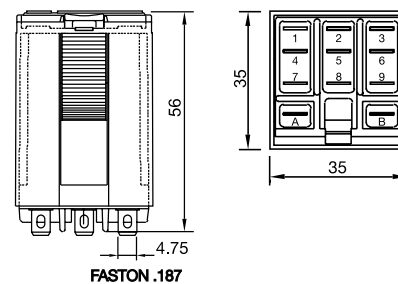


fig. 2 DC voltage endurance



### Dimensions (mm)



### Technical approvals, conformities



IEC/EN 61810; IEC/EN 60947

## C5-M2x

2 pole | normally open contact with blow magnet | Faston

<b>Maximum contact load</b>	<b>16 A / 250 V AC-1</b>	<b>7 A / 110 V DC-1</b>
		<b>3 A / 220 V DC-1</b>
<b>Recommended minimum contact load</b>	<b>10mA/10V</b>	

### Contacts

Material	Standard	Code 0	⚡ AgNi
Rated Load			16 A
Max. inrush current (20 ms)			40 A
Switching voltage max.			250 V
AC load fig. 1			4 kVA
DC load			see fig. 2

### Coil

Coil resistance	see table; tolerance $\pm 10\%$
Pick-up voltage	$\geq 0.8 \times U_N$
Release voltage	$\geq 0.1 \times U_N$
Nominal power	2.4 VA (AC) / 1.6 W (DC)

### Coil table

V AC	$\Omega$	mA	V DC	$\Omega$	mA
24	65	100	12	90	133
48	286	50	24	373	66
115	1K7	21	48	1K4	33
230	6K8	10.4	110	7K6	15

### Insulation

Contact open	2 kV
Contact/contact	4 kV
Contact/coil	3 kV
Insulation resistance at 500 V	$\geq 3 \text{ G}\Omega$
Insulation, EN 60947/IEC 61810-1:	4 kV

### Specifications

Ambient temperature operation/storage	-40...60 °C / -40 ... 80 °C (no ice)
Pick-up time/bounce time	20 ms / $\leq 3$ ms
Release time/bounce time	10 ms / $\leq 1$ ms
Mechanical life ops	AC: 10 Mill./DC: 20 Mill. switching cycles
DC Rated load	$\geq 75$ 000 switching cycles
Max. switching frequency at rated load	1200/h
Weight	90 g

### Product References

V AC 50 Hz/60 Hz: 24, 48, 115 (120), 230 (240)

LED

RC Suppressor

C5-M20/AC ... V

C5-M20X/AC ... V

C5-M20R/AC ... V

V DC 12, 24, 48, 110, 220

LED

Free wheeling diode

Polarity and free wheeling diode

C5-M20/DC ... V

C5-M20X/DC ... V

C5-M20DX/DC ... V

C5-M20FX/DC ... V

AC/DC bridge rectifier 24 V, 48 V, 60 V

Other voltages on request

C5-M20BX/UC ... V

"..." List Coil Voltage to complete Product References

### Accessories

Socket	S5-M, S5-P
Wall Mounting Adapter	S5-R (BAG 5 PCS)
Blanking Plug	SO-NP (BAG 10 PCS)



### Connection diagram

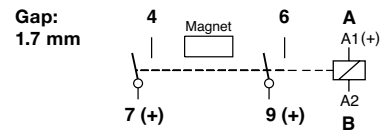


fig. 1 AC voltage endurance

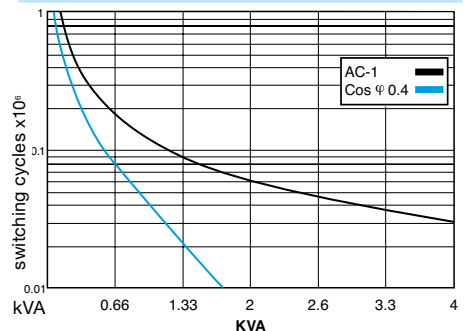
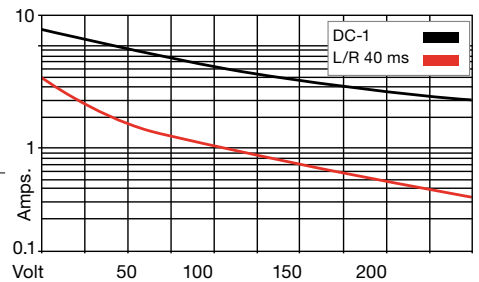
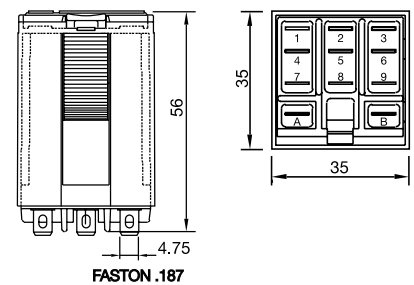


fig. 2 DC load limit curve



### Dimensions (mm)



### Technical approvals, conformities



IEC/EN 61810; IEC/EN 60947

# C5-R2x

2 pole | changeover contact | remanance

<b>Maximum contact load</b>	<b>10 A/400 V AC-1</b>	<b>10 A/30 V DC-1</b>
	<b>0.2 A/250 V DC-1</b>	<b>0.5 A/110 V DC-1</b>
<b>Recommended minimum contact load</b>	<b>10mA/10V</b>	

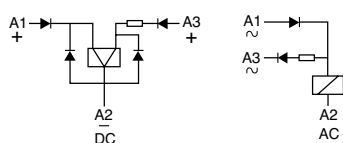
### Contacts

Material	Standard	Code 0	⚡ AgNi
Rated Load			10 A
Max. inrush current (20 ms)			30 A
Switching voltage max.			400 V
AC load fig. 1			4 kVA
DC load			see fig. 2

### Coil

Coil resistance	see table; tolerance ± 10 %
ON pulse power	1.5 VA/W
OFF pulse power	0.5 VA/W 1 winding for AC, 2 winding for DC
Pull-in ON OFF	< 0.8 x U <sub>N</sub>

### Internal Diagram:



### Coil table

V AC	mA ON	mA OFF	V DC	mA ON	mA OFF
24	75	12	12	125	41
48	38	6	24	63	21
115	16	2.5	48	31	10
230	8	1.3	110	14	4.5

### Insulation

Contact open	1000 V
Contact/contact	4 kV
Contact/coil	4 kV
Insulation resistance at 500 V	≥3 GΩ
Insulation, EN 60947/IEC 61810-1	4 kV

### Specifications

Ambient temperature operation/storage	-40...60 °C / -40 ... 80 °C (no ice)
Minimum pulse ON OFF	50 ms
Mechanical life ops	AC: 10 Mill./DC: 20 Mill.
DC voltage endurance at rated load	≥100 000 switching cycles
Max. switching frequency at rated load	1200/h
Weight	95 g

### Product References

V AC 50 Hz/60 Hz: 24, 48, 115, 230

C5-R20/AC ... V

V DC 12, 24, 48, 110,

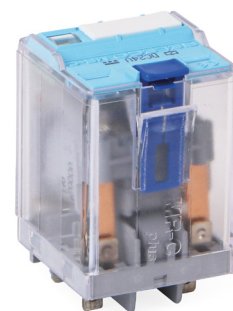
C5-R20/DC ... V

Other voltages on request

"..." List Coil Voltage to complete Product References

### Accessories

Socket	S5-M, S5-P
Wall Mounting Adapter	S5-R (BAG 5 PCS)
Blanking Plug	SO-NP (BAG 10 PCS)



### Connection diagram

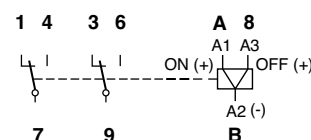


fig. 1 AC voltage endurance

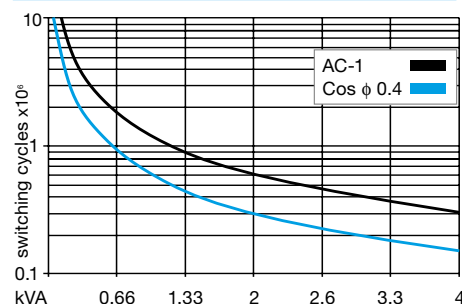
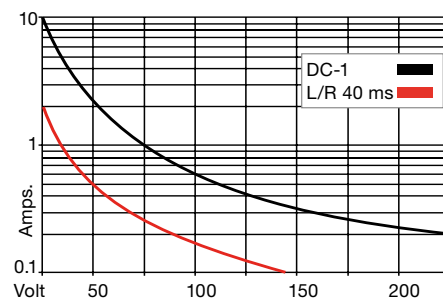
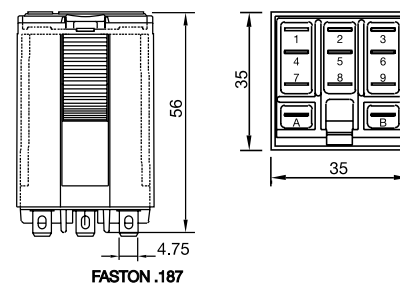


fig. 2 DC load limit curve



### Dimensions (mm)



### Technical approvals, conformities



IEC/EN 61810; IEC/EN 60947

# C7-A1x

## 1 pole | changeover contact | Faston

<b>Maximum contact load</b>	<b>16 A/250 V AC-1</b>	<b>0.5 A/110 V DC-1</b>
	<b>16 A/24 V DC-1</b>	<b>0.2 A/220 V DC-1</b>
<b>Recommended minimum contact load</b>	<b>10mA/10V</b>	

### Contacts

Material	Standard	Code 0	⚡ AgNi
Rated Load			16 A
Max. inrush current (20 ms)			40 A (120 A for code 5)
Switching voltage max.			250 V
AC load fig. 1			4 kVA
DC load			see fig. 2

### Coil

Coil resistance	see table; tolerance ± 10 %
Pick-up voltage	≤ 0.8 × U <sub>N</sub>
Release voltage	≥ 0.1 × U <sub>N</sub>
Nominal power	1.2 VA (AC)/1.3 W (DC)

### Coil table

V AC	Ω	mA	V DC	Ω	mA
24	174	50	12	111	108
48	686	25	24	432	55
115	4K3	10.4	48	1K7	28
230	18K6	5.2	110	9K2	12

### Insulation

Contact open	1000 V
Contact/coil	2.5 kV
Insulation resistance at 500 V	≥ 1 GΩ
Insulation, IEC 61810-1	2.5 kV

### Specifications

Ambient temperature operation/storage	-40...60 °C / -40 ... 80 °C (no ice)
Pick-up time/bounce time	16 ms / ≤ 3 ms
Release time/bounce time	8 ms / ≤ 1 ms
Mechanical life ops	AC: 10 Mill./DC: 20 Mill.
AC/DC voltage endurance at rated load	≥ 100 000 switching cycles
Max. switching frequency at rated load	1200/h
Weight	43 g

### Product References

V AC 50 Hz/60 Hz: 24, 48, 115 (120), 230 (240)

LED

C7-A10X/AC ... V

V DC 12, 24, 48, 110

LED

C7-A10X/DC ... V

Free wheeling diode (only 24 DC)

C7-A10DX/DC 24 V

Polarity and free wheeling diode

C7-A10FX/DC ... V

Other voltages on request

"..." List Coil Voltage to complete Product References

### Accessories

Socket	<b>S7-C, S7-IO, S7-P</b>
Push only	<b>S9-OP (BAG 10 PCS)</b>
Blanking Plug	<b>S9-NP (BAG 10 PCS)</b>



Connection diagram

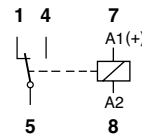


fig. 1 AC voltage endurance

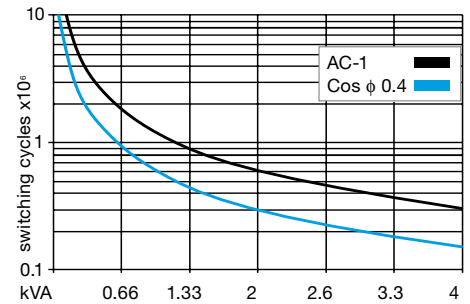
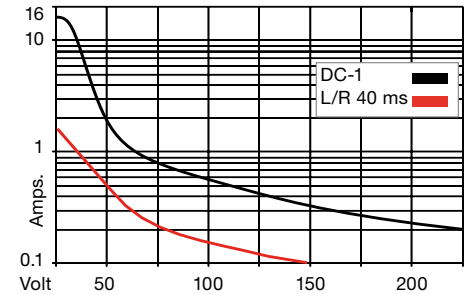
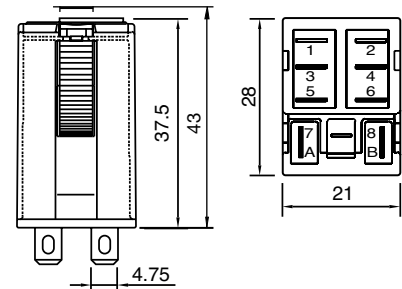


fig. 2 DC load limit curve



Dimensions (mm)



### Technical approvals, conformities



IEC/EN 61810; IEC/EN 60947

## C7-A2x

2 pole | changeover contact | Faston

<b>Maximum contact load</b>	10 A/250 V AC-1	0.5 A/110 V DC-1
	10 A/30 V DC-1	0.2 A/220 V DC-1
<b>Recommended minimum contact load</b>	10 mA/10 V Code 0	
	5 mA/5 V Code 8	

### Contacts

Material	Standard	Code 0	⚡ AgNi
	Optional	Code 8	⚡ AgNi + 5 μ Au
Rated Load			10 A
Max. inrush current (20 ms)			30 A
Switching voltage max.			250 V
AC load fig. 1			2.5 kVA
DC load			see fig. 2

### Coil

Coil resistance	see table; tolerance ± 10 %
Pick-up voltage	≤ 0.8 × U <sub>n</sub>
Release voltage	≥ 0.1 × U <sub>n</sub>
Nominal power	1.2 VA (AC)/1 W (DC)

### Coil table

V AC	Ω	mA	V DC	Ω	mA
24	174	50	12	148	85
48	686	25	24	594	43
115	4K3	10.4	48	2K3	21
230	18K6	5.2	110	11K4	10

### Insulation

Contact open	1000 V
Contact/contact	2.5 kV
Contact/coil	2.5 kV
Insulation resistance at 500 V	≥ 1 GΩ
Insulation, IEC 61810-1	2.5 kV

### Specifications

Ambient temperature operation/storage	-40...60 °C / -40 ... 80 °C (no ice)
Pick-up time/bounce time	16 ms / ≤ 3 ms
Release time/bounce time	8 ms / ≤ 1 ms
Mechanical life ops	AC: 10 Mill./DC: 20 Mill.
DC voltage endurance at rated load	≥ 100 000 switching cycles
Max. switching frequency at rated load	1200/h
Weight	43 g

### Product References

V AC 50 Hz/60 Hz: 24, 48, 115 (120), 230 (240)

#### LED

C7-A20X/AC ... V C7-A28X/AC ... V

V DC 12, 24, 48, 110

#### LED

C7-A20X/DC ... V C7-A28X/DC ... V

Free wheeling diode (only 24 DC)

C7-A20DX/DC 24 V C7-A28DX/DC 24 V

Polarity and free wheeling diode

C7-A20FX/DC ... V C7-A28FX/DC ... V

AC/DC bridge rectifier 24 V, 48 V, 60 V

C7-A20BX/UC ... V C7-A28BX/UC ... V

Other voltages on request

"..." List Coil Voltage to complete Product References

### Accessories

Socket	S7-C, S7-IO, S7-P,
Push only	S9-OP (BAG 10 PCS)
Blanking Plug	S9-NP (BAG 10 PCS)



### Connection diagram

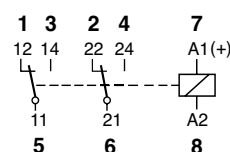


fig. 1 AC voltage endurance

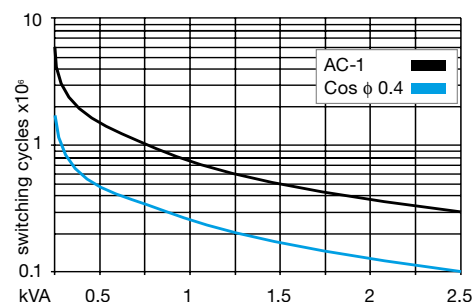
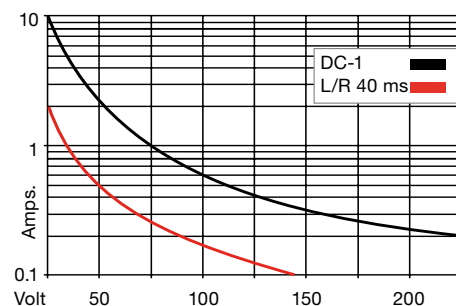
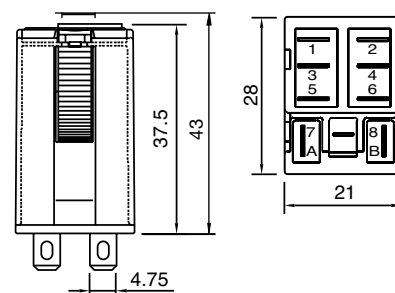


fig. 2 DC load limit curve



### Dimensions (mm)



### Technical approvals, conformities



**C7-T2x**

**2 pole | changeover twin contact**

<b>Maximum contact load</b>	<b>6 A/250 V</b>	<b>AC-1</b>	<b>6 A/30 V</b>	<b>DC-1</b>
<b>Recommended minimum contact load</b>	<b>5 mA/5 V</b>	<b>Code 1</b>		
	<b>1 mA/5 V</b>	<b>Code 2</b>		

**Contacts**

Material	Standard	Code 1	AgNi + 0.2 μ Au
	Optional	Code 2	AgNi + 5 μ Au
Rated Load			6 A
Max. inrush current (20 ms)			15 A
Switching voltage max.			250 V
AC load fig. 1			1.2 kVA
DC load			see fig. 2

**Coil**

Coil resistance	see table; tolerance ± 10 %
Pick-up voltage	≤ 0.8 x U <sub>N</sub>
Release voltage	≥ 0.1 x U <sub>N</sub>
Nominal power	1.2 VA (AC)/1 W (DC)

**Coil table**

V AC	Ω	mA	V DC	Ω	mA
24	174	50	12	148	85
48	686	25	24	594	43
115	4K3	10.4	48	2K3	21
230	18K6	5.2	110	11K4	10

**Insulation**

Contact open	1000 V
Contact/contact	2.5 kV
Contact/coil	2.5 kV
Insulation resistance at 500 V	≥ 1 GΩ
Insulation, IEC 61810-1	2.5 kV

**Specifications**

Ambient temperature operation/storage	-40...60 °C / -40 ... 80 °C (no ice)
Pick-up time/bounce time	16 ms / ≤ 3 ms
Release time/bounce time	8 ms / ≤ 1 ms
Mechanical life ops	AC: 10 Mill./DC: 20 Mill.
DC voltage endurance at rated load	≥ 100 000 switching cycles
Max. switching frequency at rated load	1200/h
Weight	43 g

**Product References**

**V AC 50 Hz/60 Hz: 230 (240)**

**LED**

**C7-T21X/AC ... V**

**C7-T22X/AC230V**

**V DC 12, 24, 48, 110**

**LED**

**C7-T21X/DC ... V**

**C7-T21DX/DC24V**

**C7-T21FX/DC ... V**

**C7-T22FX/DC110V**

**Polarity and free wheeling diode**

**C7-T21BX/UC ... V**

**C7-T22BX/UC24V**

**AC/DC bridge rectifier 24 V, 48 V**

**C7-T22BX/UC48V**

Other voltages on request

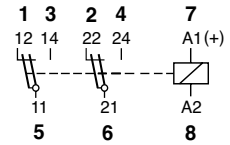
"..." List Coil Voltage to complete Product References

**Accessories**

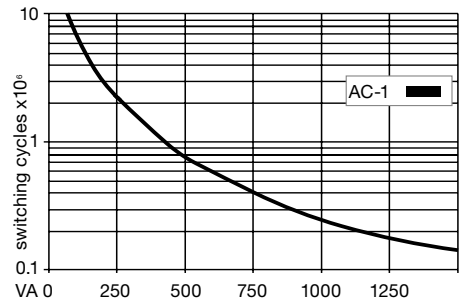
Socket	<b>S7-C, S7-IO, S7-P,</b>
Push only	<b>S9-OP (BAG 10 PCS)</b>
Blanking Plug	<b>S9-NP (BAG 10 PCS)</b>



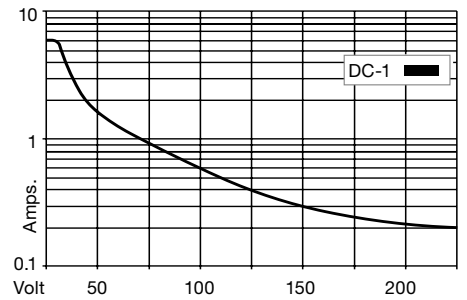
**Connection diagram**



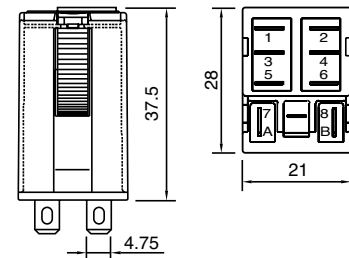
**fig. 1 AC voltage endurance**



**fig. 2 DC load limit curve**



**Dimensions (mm)**



**Technical approvals, conformities**



IEC/EN 61810; IEC/EN 60947



## C7-G2x

2 pole | normally open contact | Faston

<b>Maximum contact load</b>	<b>10 A/250 V AC-1</b>	<b>0.8 A/110 V DC-1</b>
	<b>10 A/30 V DC-1</b>	<b>0.4 A/220 V DC-1</b>
<b>Recommended minimum contact load</b>	<b>10mA/10V</b>	

### Contacts

Material	Standard	Code 0	⚡ AgNi
Rated Load			10 A
Max. inrush current (20 ms)			30 A
Switching voltage max			250 V
AC load fig. 1			2.5 kVA
DC load			see fig. 2

### Coil

Coil resistance	see table; tolerance ± 10 %
Pick-up voltage	≤ 0.8 × U <sub>N</sub>
Release voltage	≥ 0.1 × U <sub>N</sub>
Nominal power	1.5 VA (AC)/1.5 W (DC)

### Coil table

V AC	Ω	mA	V DC	Ω	mA
24	153	62	12	99	121
48	611	31	24	388	61
115	3K6	13	48	1K5	32
230	14K6	6.5	110	8K	14

### Insulation

Contact open	2000 V
Contact/contact	2.5 kV
Contact/coil	2.5 kV
Insulation resistance at 500 V	≥ 1 GΩ
Insulation, IEC 61810-1	2.5 kV

### Specifications

Ambient temperature operation/storage	-40...60 °C / -40 ... 80 °C (no ice)
Pick-up time/bounce time	20 ms / ≤ 3 ms
Release time/bounce time	10 ms / ≤ 1 ms
Mechanical life ops	AC: 10 Mill./DC: 20 Mill.
DC voltage endurance at rated load	≥ 100 000 switching cycles
Max. switching frequency at rated load	1200/h
Weight	43 g

### Product References

**V AC 50 Hz/60 Hz: 24, 48, 115 (120), 230 (240) LED**

**C7-G20X/AC ... V**

**V DC 12, 24, 48, 110**

**LED**

**Polarity and free wheeling diode**

**C7-G20FX/DC ... V**

**AC/DC bridge rectifier 24 V, 48 V, 60 V**

Other voltages on request

**C7-G20BX/UC ... V**

"..." List Coil Voltage to complete Product References

### Accessories

Socket	<b>S7-C, S7-IO, S7-P,</b>
Push only	<b>S9-OP (BAG 10 PCS)</b>
Blanking Plug	<b>S9-NP (BAG 10 PCS)</b>



### Connection diagram

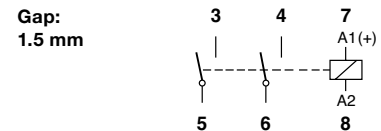


fig. 1 AC voltage endurance

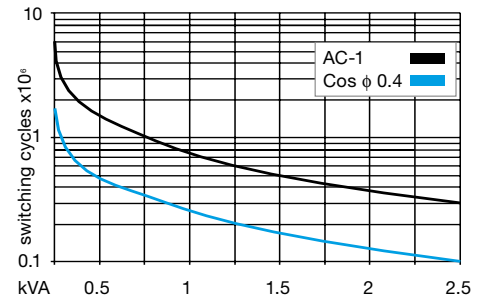
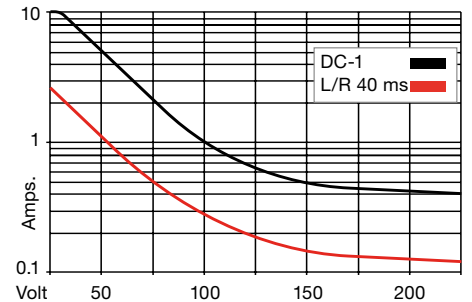
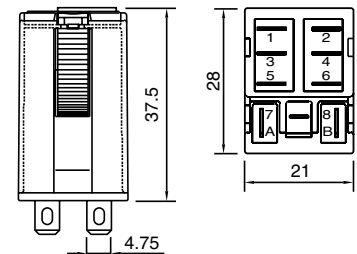


fig. 2 DC load limit curve



### Dimensions (mm)



### Technical approvals, conformities



IEC/EN 61810; IEC/EN 60947

**C7-H2x**

**2 pole | changeover contact | Faston**

<b>Maximum contact load</b>	<b>10 A / 250 V AC-1</b>	<b>6 A / 250 V AC-1</b>
	<b>10 A / 30 V DC-1</b>	<b>6 A / 30 V DC-1</b>
<b>Recommended minimum contact load</b>	<b>10 mA/10 V (Power contacts)</b>	
	<b>5 mA/5V (twin contacts)</b>	

**Contacts**

Material	Standard	Code 3	AgNi + 3 μ Au
Rated Load			10 A
Max. inrush current (20 ms)			30 A
Switching voltage max.			2,5 kV
AC load fig. 1			2,5 VA
DC load			see fig. 2

**Coil**

Coil resistance	see table; tolerance ± 10 %
Pick-up voltage	≤ 0.8 x U <sub>N</sub>
Release voltage	≥ 0.1 x U <sub>N</sub>
Nominal power	1.2 VA (AC)/1 W (DC)

**Coil table**

V AC	Ω	mA	V DC	Ω	mA
230	18K6	5.2	24	594	43

**Insulation**

Contact open	1000 V
Contact/contact	2.5 kV
Contact/coil	2.5 kV
Insulation, IEC 61810-1	2.5 kV

**Specifications**

Ambient temperature operation/storage	-40...60 °C / -40 ... 80 °C (no ice)
Pick-up time/bounce time	16 ms / ≤ 3 ms
Release time/bounce time	8 ms / ≤ 1 ms
Mechanical life ops	AC: 10 Mill./DC: 20 Mill.
DC voltage endurance at rated load	≥100 000 switching cycles
Max. switching frequency at rated load	1200/h
Weight	43 g

**Product References**

**LED (only 230 V AC)**

**C7-H23X/AC 230 V**

**Free wheeling diode (only 24 DC)**

**C7-H23X/DC 24 V**

Other voltages on request

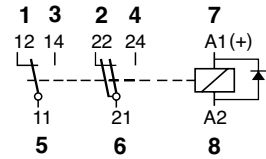
"..." List Coil Voltage to complete Product References

**Accessories**

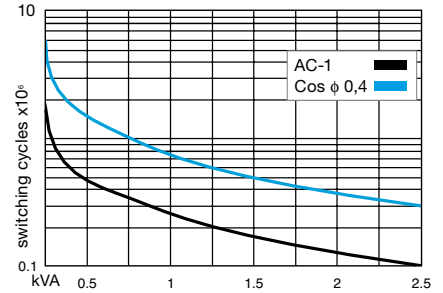
Socket	<b>S7-C, S7-IO, S7-P,</b>
Push only	<b>S9-OP (BAG 10 PCS)</b>
Blanking Plug	<b>S9-NP (BAG 10 PCS)</b>



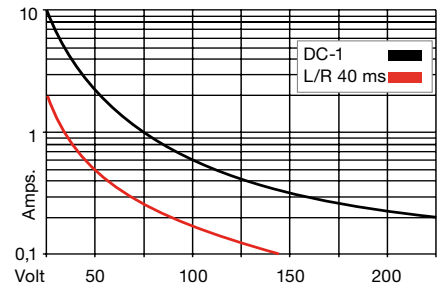
**Connection diagram**



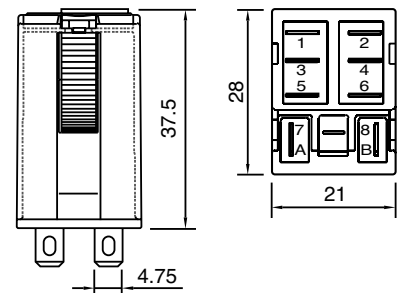
**fig. 1 AC voltage endurance**



**fig. 2 DC load limit curve**



**Dimensions (mm)**



**Technical approvals, conformities**



IEC 61810; EN 60947

# C7-X1x

1 pole | normally open serial contact | Faston

<b>Maximum contact load</b>	<b>10 A/250 V AC-1</b>	<b>6 A/110 V DC-1</b>
	<b>10 A/30 V DC-1</b>	<b>1 A/220 V DC-1</b>
<b>Recommended minimum contact load</b>	<b>10mA/10V</b>	

### Contacts

Material	Standard	Code 0	⚡ AgNi
Rated Load			10 A
Max. inrush current (20 ms)			30 A
Switching voltage max.			250 V
AC load			2.5 kVA
DC load			see fig. 2

### Coil

Coil resistance	see table; tolerance ± 10 %
Pick-up voltage	≤ 0.8 × U <sub>N</sub>
Release voltage	≥ 0.1 × U <sub>N</sub>
Nominal power	1.5 VA (AC)/1.3 W (DC)

### Coil table

V AC	Ω	mA	V DC	Ω	mA
24	153	62	12	111	108
48	611	31	24	432	55
115	3K6	13	48	1K7	27
230	14K6	6.5	110	9K2	12

### Insulation

Contact open	2.5 kV
Contact/coil	2.5 kV
Insulation resistance at 500 V	≥ 1 GΩ
Insulation, IEC 61810-1	2.5 kV

### Specifications

Ambient temperature operation/storage	-40...60 °C / -40 ... 80 °C (no ice)
Pick-up time/bounce time	20 ms / ≤ 3 ms
Release time/bounce time	10 ms / ≤ 1 ms
Mechanical life ops	AC: 10 Mill./DC: 20 Mill.
DC voltage endurance at rated load	≥ 100 000 switching cycles
Max. switching frequency at rated load	1200/h
Weight	43 g

### Product References

V AC 50 Hz/60 Hz: 24, 48, 115 (120), 230 (240)

LED

V DC 12, 24, 48, 110

LED

Free wheeling diode (only 24 DC)

Polarity and free wheeling diode

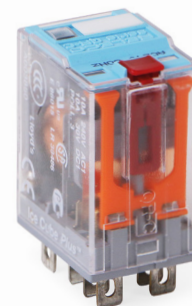
AC/DC bridge rectifier 24 V, 48 V, 60 V

Other voltages on request

"..." List Coil Voltage to complete Product References

### Accessories

Socket	<b>S7-C, S7-IO, S7-P,</b>
Push only	<b>S9-OP (BAG 10 PCS)</b>
Blanking Plug	<b>S9-NP (BAG 10 PCS)</b>



### Connection diagram

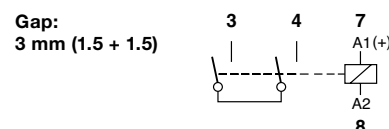


fig. 1 AC voltage endurance

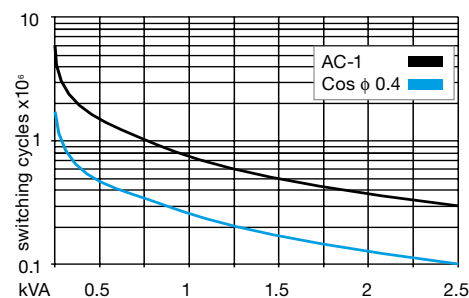
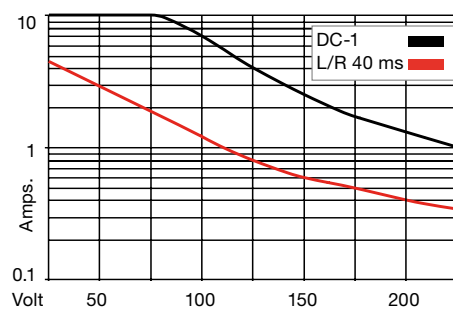
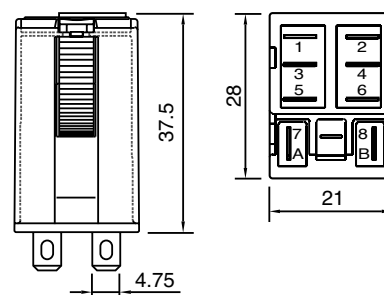


fig. 2 DC load limit curve



### Dimensions (mm)



### Technical approvals, conformities



IEC/EN 61810; IEC/EN 60947

### C7-W1x

1 pole | normally open tungsten pre-contact | Faston

<b>Maximum contact load:</b>	<b>10 A/250 V AC-1</b>	<b>6 A / 250 V AC-5a/b</b>
<b>Recommended minimum contact load:</b>	<b>10 mA/10 V</b>	

#### Contacts

Material	Standard	Code 0	AgNi/W
Rated Load			10 A
Max. inrush current (2.5 ms)			500 A
Switching voltage max.			250 V
AC load fig. 1			2.5 kVA
DC load			see fig. 2

#### Coil

Coil resistance	see table; tolerance $\pm 10\%$
Pick-up voltage	$\leq 0.8 \times U_N$
Release voltage	$\geq 0.1 \times U_N$
Nominal power	1.5 VA (AC)/1.5 W (DC)

#### Coil table

V AC	$\Omega$	mA	V DC	$\Omega$	mA
24	153	62	12	99	121
48	611	31	24	388	61
115	3K6	13	48	1K5	32
230	14K5	6.5	110	8K	14

#### Insulation

Contact open	1000 V
Contact/coil	2.5 kV
Insulation resistance at 500 V	$\geq 1 \text{ G}\Omega$
Insulation, IEC 61810-1	2.5 kV

#### Specifications

Ambient temperature operation/storage	-40...60 °C / -40 ... 80 °C (no ice)
Pick-up time/bounce time	20 ms / $\leq 3$ ms
Release time/bounce time	10 ms / $\leq 1$ ms
Mechanical life ops	AC: 10 Mill./DC: 20 Mill.
DC voltage endurance at rated load	$\geq 100\,000$ switching cycles
Max. switching frequency at rated load	1200/h
Weight	43 g

#### Product References

V AC 50 Hz/60 Hz: 24, 48, 115 (120), 230 (240)  
LED

C7-W10X/AC ... V

V DC 12, 24, 48, 110  
LED

Polarity and free wheeling diode

C7-W10FX/DC ... V

AC/DC bridge rectifier 24 V, 48 V, 60 V

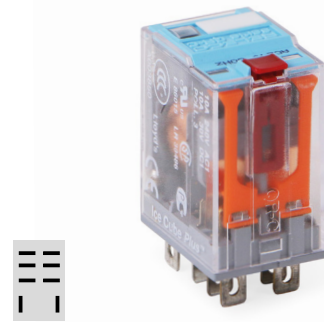
Other voltages on request

C7-W10BX/UC ... V

"..." List Coil Voltage to complete Product References

#### Accessories

Socket	<b>S7-C, S7-IO, S7-P,</b>
Push only	<b>S9-OP (BAG 10 PCS)</b>
Blanking Plug	<b>S9-NP (BAG 10 PCS)</b>



#### Connection diagram

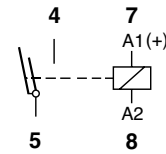


fig. 1 AC voltage endurance

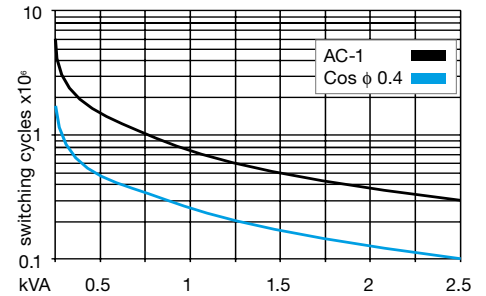
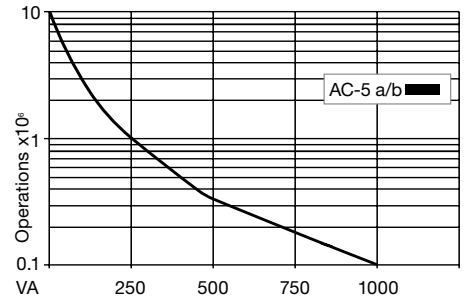
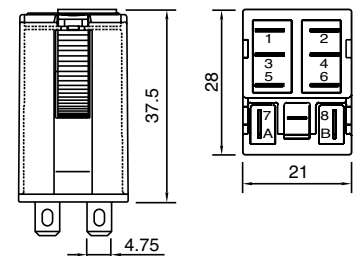


fig. 2 DC load limit curve



#### Dimensions (mm)



#### Technical approvals, conformities



IEC/EN 61810; IEC/EN 60947



## R7-A2x

### 2 pole | changeover contact | Faston

<b>Maximum contact load:</b>	<b>10 A/250 V AC-1</b>	<b>10A/30V DC-1</b>
<b>Recommended minimum contact load</b>	<b>10 mA/10 V Code 0</b>	
	<b>5 mA/5 V Code 8</b>	

#### Contacts

Material	Standard	Code 0	⚡ AgNi
	Optional	Code 8	⚡ AgNi + 5 μ Au
Rated Load	10 A		
Max. inrush current (20 ms)	30 A		
Switching voltage max.	250 V		
AC load	see fig. 1		
DC load	see fig. 2		

#### Coil

Coil resistance	see table; tolerance ± 10 %
Operating range	0,7 U <sub>N</sub> ... 1,25 U <sub>N</sub>
Pick-up voltage	≥ 0,1 x U <sub>N</sub>
Nominal power	1,07 W

#### Coil table

Voltage	Ω ± 10%	mA
24	535	45
48	2004	24
72	4750	15
110	11337	10

#### Insulation

Contact open	1000V
Contact/Contact	4kV / 2200V
Contact/coil	4kV / 2200V
Insulation resistance at 500 V	≥ 1 GΩ
Insulation, IEC 61810-1	2,5 kV

#### Specifications

Ambient temperature operation/storage	-25...70 °C / -40 ... 80 °C (no ice)
Pick-up time/bounce time	16 ms / ≤ 3 ms
Release time/bounce time	8 ms / ≤ 1 ms
Mechanical life ops	AC: 10 Mill./DC: 20 Mill.
DC voltage endurance at rated load	≥ 100 000 switching cycles
Max. switching frequency at rated load	1200/h
Weight	35 g

#### Product References

V DC 12, 24, 48, 72, 110

LED + free wheeling diode

R7-A20DX/DC...V

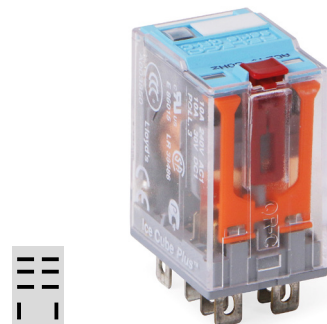
R7-A28DX/DC...V

Other voltages on request

"..." List Coil Voltage to complete Product References

#### Accessories

Socket **S7-C, S7-I/O, S7-P**



#### Connection diagram

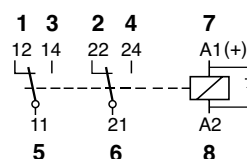


fig. 1 AC voltage endurance

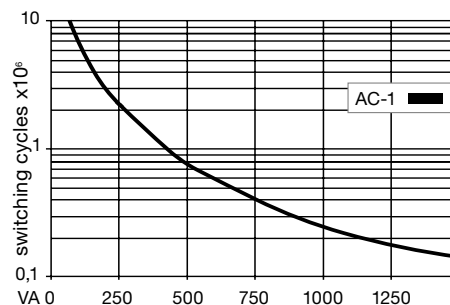
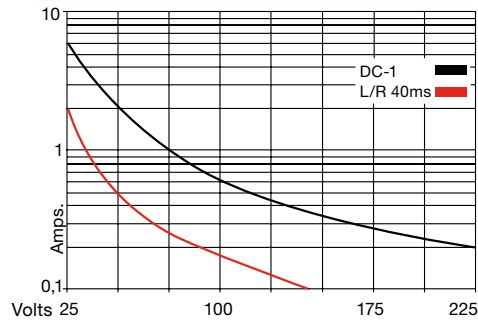
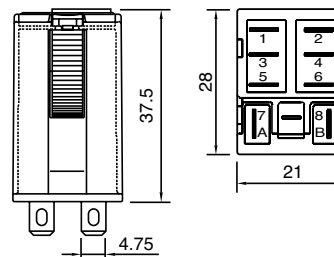


fig. 2 DC load limit curve



#### Dimensions (mm)



#### Technical approvals, conformities



IEC 60077; EN 60077-1-2/99; EN 61373/99

**R7-T2x**

**2 pole | changeover twin contact**



<b>Maximum contact load:</b>	<b>10 A/250 V AC-1</b>	<b>10A/30V DC-1</b>
<b>Recommended minimum contact load</b>	<b>10 mA/10 V Code 2</b>	

**Contacts**

Material	Standard	Code 2	AgNi + 5 μ Au
----------	----------	--------	---------------

Rated Load	6 A
Max. inrush current (20 ms)	30 A
Switching voltage max.	250 V
AC load	see fig. 1
DC load	see fig. 2

**Coil**

Coil resistance	see table; tolerance ± 10 %
Pick-up voltage	0,7 U <sub>N</sub> ... 1,25 U <sub>N</sub>
Release voltage	≥ 0,1 x U <sub>N</sub>
Nominal power	1,07 W

**Coil table**

Voltage	Ω ± 10%	mA
24	535	45
48	2004	24
72	4750	15
110	11337	10

**Insulation**

Contact open	1000V
Contact/Contact	4kV / 2200V
Contact/coil	4kV / 2200V
Insulation resistance at 500 V	≥1 GΩ
Insulation, IEC 61810-1	2,5 kV

**Specifications**

Ambient temperature operation/storage	-25...70 °C / -40 ... 80 °C (no ice)
Pick-up time/bounce time	16 ms / ≤ 3 ms
Release time/bounce time	8 ms / ≤ 1 ms
Mechanical life ops	AC: 10 Mill./DC: 20 Mill.
DC voltage endurance at rated load	≥100 000 switching cycles
Max. switching frequency at rated load	1200/h
Weight	35 g

**Product References**

**V DC 12, 24, 72, 110**

**LED + free wheeling diode**

**R7-T22DX/DC...V**

Other voltages on request

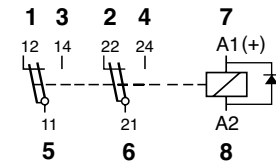
"..." List Coil Voltage to complete Product References

**Accessories**

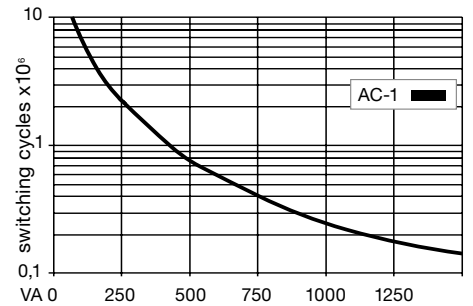
Socket **S7-C, S7-I/O, S7-P**



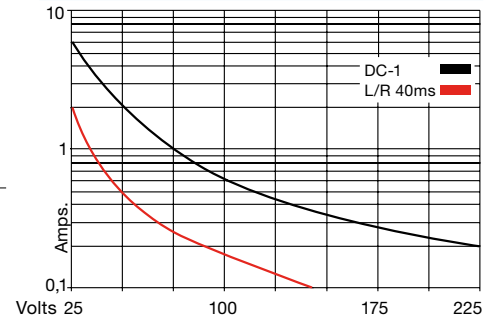
**Connection diagram**



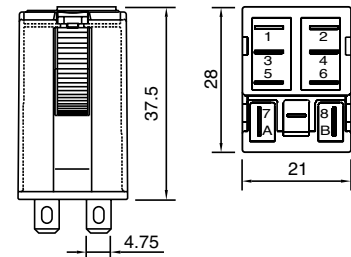
**fig. 1 AC voltage endurance**



**fig. 2 DC load limit curve**



**Dimensions (mm)**



**Technical approvals, conformities**



IEC 60077; EN 60077-1-2/99; EN 61373/99

# C9-A4x

4 pole | changeover contact | Faston

<b>Maximum contact load</b>	<b>5 A/250 V AC-1</b>	<b>5 A/30 V DC-1</b>
<b>Recommended minimum contact load</b>	<b>10 mA/10 V Code 1</b>	<b>1 mA/5 V Code 2</b>

### Contacts

Material	Standard	Code 1	AgNi + 0.2 μ Au
	Optional	Code 2	AgNi + 5 μ Au
Rated Load	5 A		
Max. inrush current (20 ms)	15 A		
Switching voltage max (same polarity)	250 V		
AC load fig. 1	1250 VA		
DC load	see fig. 2		

### Coil

Coil resistance	see table; tolerance ± 10 %
Pick-up voltage	≤ 0.8 × U <sub>n</sub>
Release voltage	≥ 0.1 × U <sub>n</sub>
Nominal power	1.2 VA (AC)/1 W (DC)

### Coil table

V AC	Ω	mA	V DC	Ω	mA
24	174	50	12	148	81
48	686	25	24	594	40
115	4K3	10.4	48	2K3	21
230	18K6	5.2	110	11K4	11

### Insulation

Contact open	1000 V
Contact/contact	2 kV
Contact/coil	2.5 kV
Insulation resistance at 500 V	≥ 1 GΩ
Insulation, IEC 61810-1	2.5 kV

### Specifications

Ambient temperature operation/storage	-40...60 °C / -40 ... 80 °C (no ice)
Pick-up time/bounce time	10 ms / ≤ 3 ms
Release time/bounce time	6 ms / ≤ 1 ms
Mechanical life ops	AC: 10 Mill./DC: 20 Mill.
DC voltage endurance at rated load	≥ 100 000 switching cycles
Max. switching frequency at rated load	1200/h
Weight	43 g

### Product References

V AC 50 Hz/60 Hz: 24, 48, 115, 230 (240)

#### LED

C9-A41X/AC ... V

C9-A42X/AC ... V

V DC 12, 24, 48, 110

#### LED

C9-A41X/DC ... V

C9-A42X/DC ... V

Free wheeling diode (only 24 DC)

C9-A41DX/DC 24 V

C9-A42DX/DC 24 V

Polarity and free wheeling diode

C9-A41FX/DC ... V

C9-A42FX/DC ... V

AC/DC bridge rectifier 24 V, 48 V, 60 V

C9-A41BX/UC ... V

C9-A42BX/UC ... V

Other voltages on request

"..." List Coil Voltage to complete Product References

### Accessories

Socket	S9-M, S9-P
Push only	S9-OP (BAG 10 PCS)
Blanking Plug	S9-NP (BAG 10 PCS)



Maximum voltage between two separate circuits on neighbouring contacts: 150 V  
**Not permitted:** 24 V DC next to 230 V AC, 230 V AC next to neutral, 230 V AC next to 230 V AC of different phases  
**Permitted:** 230 V AC next to 230 V AC same phase



### Connection diagram

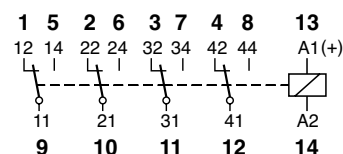


fig. 1 AC voltage endurance

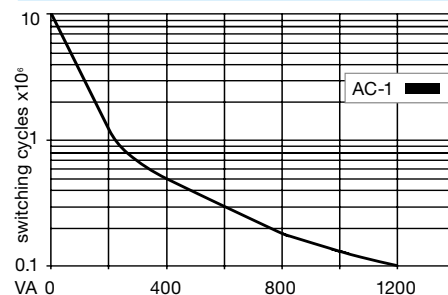
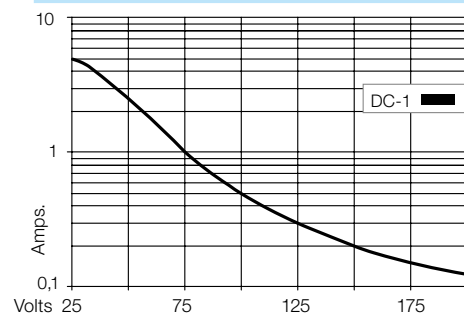
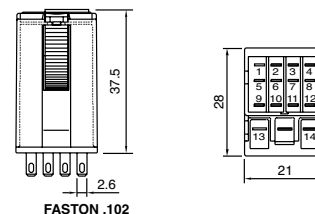


fig. 2 DC load limit curve



### Dimensions (mm)



### Technical approvals, conformities



IEC/EN 61810; IEC/EN 60947

### C9-E2x

2 pole | changeover contact | sensitive coil | Faston

<b>Maximum contact load</b>	<b>5 A/250 V AC-1</b>	<b>5 A/30 V DC-1</b>
<b>Recommended minimum contact load</b>	<b>10 mA/10 V Code 1</b>	

#### Contacts

Material	Standard	Code 1	AgNi + 0.2 μ Au
Rated Load			5 A
Max. inrush current (20 ms)			15 A
Switching voltage max.			250 V
AC load fig. 1			1200 VA
DC load			see fig. 2

#### Coil

Coil resistance	see table; tolerance ± 10 %
Pick-up voltage	≤ 0.8 × U <sub>N</sub>
Release voltage	≥ 0.1 × U <sub>N</sub>
Nominal power	0.8 VA (AC)/0.5 W (DC)

#### Coil table

V AC	Ω	mA	V DC	Ω	mA
24	238	33	12	288	42
48	1K	17	24	1K1	21
115	5K9	7	48	4K6	10
230	23K9	3.5	110	24K2	4.5

#### Insulation

Contact open	1000 V
Contact/contact	2.5 kV
Contact/coil	2.5 kV
Insulation resistance at 500 V	≥ 1 GΩ
Insulation, IEC 61810-1	2.5 kV

#### Specifications

Ambient temperature operation/storage	-40...60 °C / -40 ... 80 °C (no ice)
Pick-up time/bounce time	10 ms / ≤ 3 ms
Release time/bounce time	6 ms / ≤ 1 ms
Mechanical life	AC: 10 Mill./DC: 20 Mill.
DC voltage endurance at rated load	≥ 100 000 switching cycles
Max. switching frequency at rated load	1200/h
Weight	40 g

#### Product References

V AC 50 Hz/60 Hz: 24, 48, 115, 230 (240)

LED

C9-E21X/AC ... V

V DC 12, 24, 48, 110, 220

LED

C9-E21X/DC ... V

Free wheeling diode (only 24 DC)

C9-E21DX/DC 24 V

Polarity and free wheeling diode

C9-E21FX/DC ... V

AC/DC bridge rectifier 24 V, 48 V, 60 V

C9-E21BX/UC ... V

Other voltages on request

"..." List Coil Voltage to complete Product References

#### Accessories

Socket	S9-M, S9-P
Push only	S9-OP (BAG 10 PCS)
Blanking Plug	S9-NP (BAG 10 PCS)



#### Connection diagram

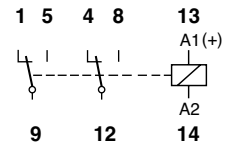


fig. 1 AC voltage endurance

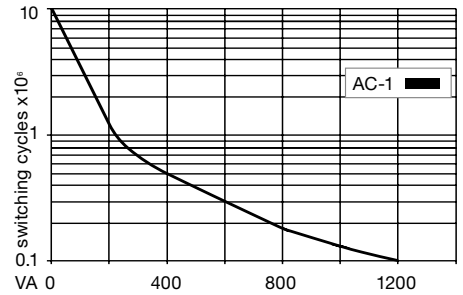
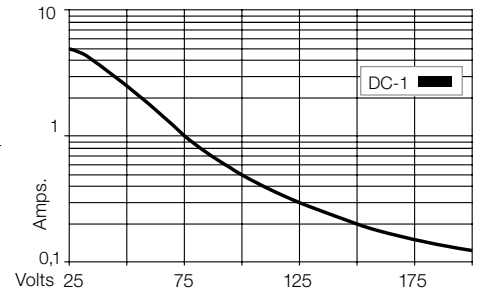
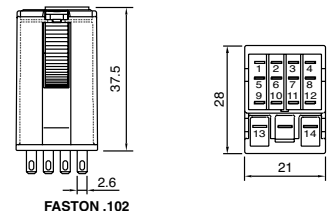


fig. 2 DC load limit curve



#### Dimensions (mm)



#### Technical approvals, conformities



IEC/EN 61810; IEC/EN 60947



# C9-R2x

2 pole | changeover contact | remanance | Faston

<b>Maximum contact load</b>	<b>5 A/120V AC-1</b>	<b>5 A/30 V DC-1</b>
<b>Recommended minimum contact load</b>	<b>10 mA/10 V</b>	

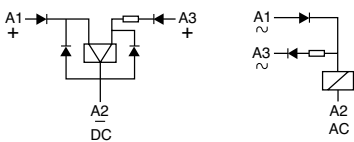
### Contacts

Material	Standard	Code 1	AgNi + 0.2 μ Au
Rated Load			5 A
Max. inrush current (20 ms)			15 A
Switching voltage max.			120V
AC load			600 VA
DC load			see fig. 2

### Coil

Coil resistance	see table; tolerance ± 10 %
ON pulse power	1.2 VA/W
OFF pulse power	0.3 VA/W
1 winding for AC, 2 winding for DC	

### Internal Diagram:



### Coil table

V AC	mA ON	mA OFF	V DC	mA ON	mA OFF
24	50	8	12	100	25
48	25	4	24	50	12
115	10	2	48	25	6
230	5	1	60	20	5

### Insulation

Contact open	1000 V
Contact/contact	2 kV
Contact/coil	2 kV
Insulation resistance at 500 V	≥1 GΩ
Insulation, IEC 61810-1	2.5 kV

### Specifications

Ambient temperature operation/storage	-40...60 °C / -40 ... 80 °C (no ice)
Minimum pulse ON OFF	50 ms
Mechanical life	AC: 10 Mill./DC: 20 Mill.
DC voltage endurance at rated load	≥100 000 switching cycles
Max. switching frequency at rated load	1200/h
Weight	43 g

### Product References

AC 50 Hz/60 Hz: 24, 48, 115, 230

C9-R21N/AC ... V

DC 12, 24, 48, 60

C9-R21N/DC ... V

Other voltages on request

"..." List Coil Voltage to complete Product References

### Accessories

Socket	S9-M, S9-P
Push only	S9-OP (BAG 10 PCS)
Blanking Plug	S9-NP (BAG 10 PCS)



### Connection diagram

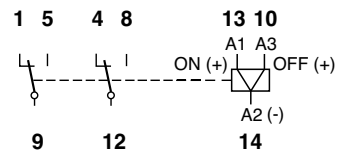


fig. 1 AC voltage endurance

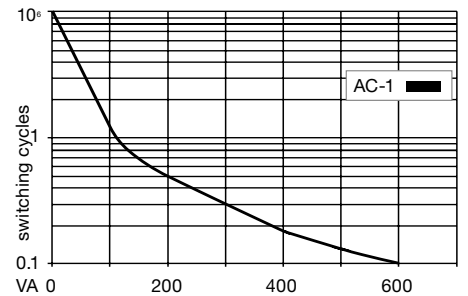
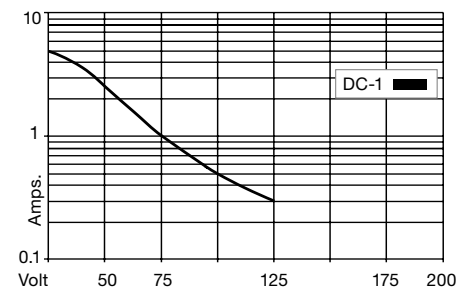
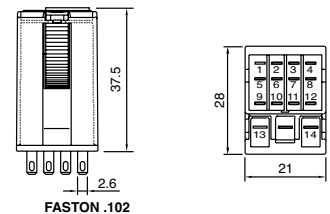


fig. 2 DC load limit curve



### Dimensions (mm)



### Technical approvals, conformities







IEC/EN 61810; IEC/EN 60947



## 1.4 Extended Lifetime Relays

---

Application	Type	Pin	Page
<b>C2x Series</b>			
Power relay	C21		68
Control relay	C22		69
<b>C3x Series</b>			
Power relay	C31		70
Control relay	C32		71

**C21**

**Power relay**

<b>Maximum contact load</b>	<b>10 A / 250 V AC-1, 10 A / 30 V DC-1</b>
<b>Recommended minimum contact load</b>	<b>50 mA / 10 V</b>

<b>Contacts</b>	
Material	⚡ AgCuNi
Rated operational current	10 A
Max. inrush current (20 ms)	40 A
Rated switching voltage AC-1	250 V
Max. AC load	2500 VA AC-1
Max. DC load 30 V / 230 V DC-1 fig. 2	300 W / 90 W

<b>Coil</b>	
Pick-up voltage	$\leq 0.8 \times U_N$
Release voltage AC / DC	$> 0.15 \times U_N / > 0.05 \times U_N$
Nominal power AC / DC	2.5 VA / 1.2 W

<b>Coil Table</b>					
$V_N$ AC	$\Omega$	mA	$V_N$ DC	$\Omega$	mA
24	52	104	12	115	104
48	240	55	24	480	50
115	1350	23	48	1850	26
230	5600	11.5	110	9000	12
			220	29000	7.6

Types with LED indicator take additional 5 ... 10 mA @ < 80 V

<b>Insulation</b>	
Contact Open	1.5 kV rms / 1 min
Contact Contact	1.5 kV rms / 1 min
Contact Coil	2 kV rms / 1 min

<b>Specifications</b>	
Ambient temperature operation, storage	-40 ... 70 °C (no ice)
Pickup time AC / DC	3 ... 10 ms / $\leq 12$ ms
Release time AC / DC	2 ... 15 ms / $\leq 3.5$ ms
Bounce time NO contact AC / DC	3 ... 6 ms / approx. 3.5 ms
Mechanical life	$\geq 100\ 000\ 000$ operations
Max. switching frequency at rated load	360/h
Weight	80 g

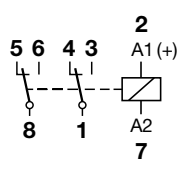
<b>Product References</b>	
<b>AC 50 Hz / 60 Hz: 24, 48, 115, 230</b>	<b>C21L/AC...V</b>
<b>LED</b>	
<b>DC: 12, 24, 48, 110, 220</b>	<b>C21DL/DC...V</b>
<b>LED + Free wheeling diode</b>	

"..." List Coil Voltage to complete Product References

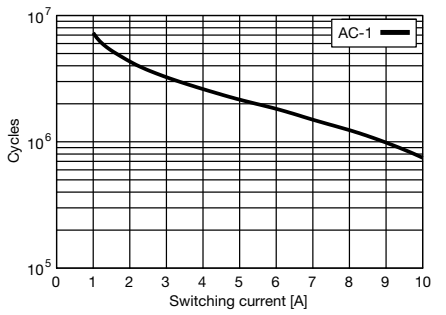
<b>Accessories</b>	
Socket	<b>S2-B, S2-PO</b>



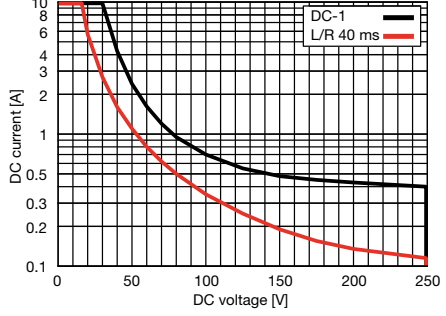
**Connection diagram**



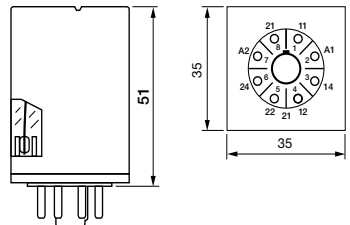
**fig. 1 AC voltage endurance**



**fig. 2 DC load limit curve**



**Dimensions (mm)**



**Technical approvals, conformities**



IEC/EN 61810; IEC/EN 60947

**C22**

**Control relay**

<b>Maximum contact load</b>	<b>6 A / 250 V AC-1</b>
	<b>6 A / 30 V DC-1</b>
<b>Recommended minimum contact load</b>	<b>10 mA / 5 V</b>

---

<b>Contacts</b>	
Material	AgCuNi
Rated operational current	6 A
Max. inrush current (20 ms)	15 A
Rated switching voltage AC-1	250 V
Max. AC load	1500 VA AC-1
Max. DC load 30V / 230V DC-1 fig. 2	200 W / 90 W

<b>Coil</b>	
Pick-up voltage	$\leq 0.8 \times U_N$
Release voltage AC / DC	$> 0.15 \times U_N / > 0.05 \times U_N$
Nominal power AC / DC	2.5 VA / 1.2 W

<b>Coil Table</b>					
$V_N$ AC	$\Omega$	mA	$V_N$ DC	$\Omega$	mA
24	52	104	12	115	104
48	240	55	24	480	50
115	1350	23	48	1850	26
230	5600	11.5	110	9000	12
			220	29000	7.6

Types with LED indicator take additional 5 ... 10 mA @ < 80 V

<b>Insulation</b>	
Contact Open	1.5 kV rms / 1 min
Contact Contact	1.5 kV rms / 1 min
Contact Coil	2 kV rms / 1 min

<b>Specifications</b>	
Ambient temperature operation, storage	-40 ... 70 °C (no ice)
Pickup time AC / DC	3 ... 10 ms / $\leq 12$ ms
Release time AC / DC	2 ... 15 ms / $\leq 3.5$ ms
Bounce time NO contact AC / DC	3 ... 6 ms / approx. 3.5 ms
Mechanical life	$\geq 100\,000\,000$ operations
Max. switching frequency at rated load	360/h
Weight	80 g

**Product References**

**AC 50 Hz / 60 Hz: 24, 48, 115, 230**

**LED**

**DC: 12, 24, 48, 110, 220**

**LED + Free wheeling diode**

**C22L/AC...V**

**C22DL/DC...V**

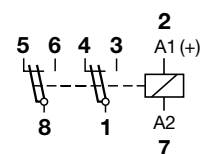
"..." List Coil Voltage to complete Product References

**Accessories**

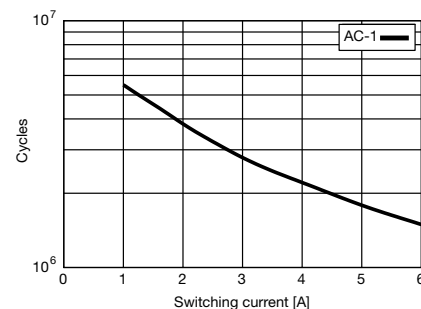
Socket **S2-B, S2-PO**



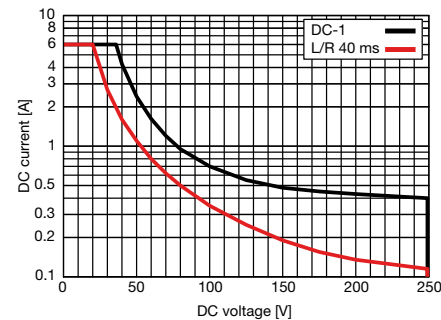
**Connection diagram**



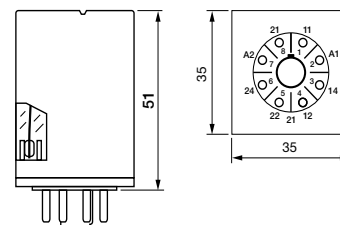
**fig. 1 AC voltage endurance**



**fig. 2 DC load limit curve**



**Dimensions (mm)**



**Technical approvals, conformities**



**C31**

**Power relay**



<b>Maximum contact load</b>	<b>10 A / 250 V AC-1</b>
	<b>10 A / 30 V DC-1</b>
<b>Recommended minimum contact load</b>	<b>50 mA / 10 V</b>

**Contacts**

Material ⚡ AgCuNi

Rated operational current 10 A

Max. inrush current (20 ms) 40 A

Rated switching voltage 250 V

Max. AC load 2500 VA AC-1

Max. DC load 30V / 230V DC-1 fig. 2 300W / 90 W

**Coil**

Pick-up voltage  $\leq 0.8 \times U_N$

Release voltage AC / DC  $> 0.15 \times U_N / > 0.05 \times U_N$

Nominal power AC / DC 2.5 VA / 1.2 W

Types with LED indicator take additional 5 ... 10 mA @ < 80 V

**Insulation**

Contact Open 1.5 kV rms / 1 min

Contact Contact 1.5 kV rms / 1 min

Contact Coil 2 kV rms / 1 min

**Specifications**

Ambient temperature operation, storage -40 ... 70 °C (no ice)

Pickup time AC / DC 3 ... 10 ms /  $\leq 12$  ms

Release time AC / DC 2 ... 15 ms /  $\leq 3.5$  ms

Bounce time NO contact AC / DC 3 ... 6 ms / approx. 3.5 ms

Mechanical life  $\geq 100\ 000\ 000$  operations

Max. switching frequency at rated load 360/h

Weight 80 g

**Product References**

**AC 50 Hz / 60 Hz: 24, 48, 115, 230 (240)**

**LED**

**DC: 12, 24, 48, 110, 220**

**LED + Free wheeling diode**

**Railway EN 50155**

**C31L/AC...V**

**C31/DC...V**

**C31DL/DC...V**

**C31D/R DC...V**

"..." List Coil Voltage to complete Product References

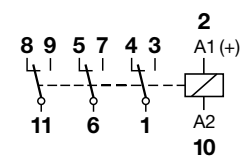
**Accessories**

Socket **S3-B, S3-S, S3-PO, S3-M0, S3-M1**

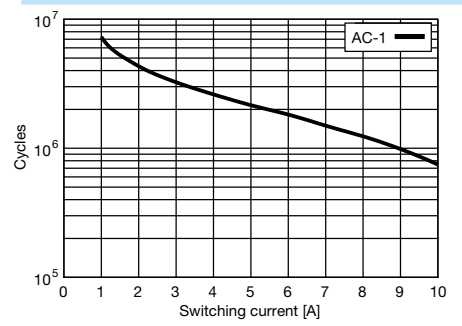
Blanking Plug **SO-NP (BAG 10 PCS)**



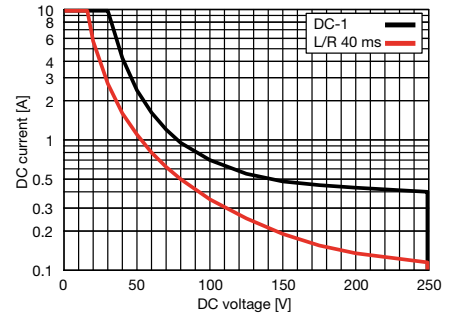
**Connection diagram**



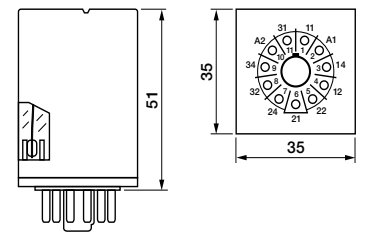
**fig. 1 AC voltage endurance**



**fig. 2 DC load limit curve**



**Dimensions (mm)**



**Technical approvals, conformities**

**UL** **us** **EAC** **CE** **RoHS** **CCC**

IEC/EN 61810; IEC/EN 60947; IEC/EN 50155  
 IEC/EN 61373; IEC/EN 45545  
 NF F 16-101/102

**C32**

**Control relay**

<b>Maximum contact load</b>	<b>6 A / 250 V AC-1</b>
	<b>6 A / 30 V DC-1</b>
<b>Recommended minimum contact load</b>	<b>1 mA / 5 V</b>

<b>Contacts</b>	
Material	AgCuNi
Rated operational current	6 A
Max. inrush current (20 ms)	15 A
Rated switching voltage AC-1	250 V
Max. AC load	1500 VA AC-1
Max. DC load 30V / 230V DC-1 fig. 2	200 W / 90 W

<b>Coil</b>	
Pick-up voltage	$\leq 0.8 \times U_N$
Release voltage AC / DC	$> 0.15 \times U_N / > 0.05 \times U_N$
Nominal power AC / DC	2.5 VA / 1.2 W

<b>Coil Table</b>					
$V_N$ AC	$\Omega$	mA	$V_N$ DC	$\Omega$	mA
24	52	104	12	115	104
48	240	55	24	480	50
115	1350	23	48	1850	26
230	5600	11.5	110	9000	12
			220	29000	7.6

Types with LED indicator take additional 5 ... 10 mA @ < 80 V

<b>Insulation</b>	
Contact Open	1.5 kV rms / 1 min
Contact Contact	1.5 kV rms / 1 min
Contact Coil	2 kV rms / 1 min

<b>Specifications</b>	
Ambient temperature operation, storage	-40 ... 70 °C (no ice)
Pickup time AC / DC	3 ... 10 ms / $\leq 12$ ms
Release time AC / DC	2 ... 15 ms / $\leq 3.5$ ms
Bounce time NO contact AC / DC	3 ... 6 ms / approx. 3.5 ms
Mechanical life	$\geq 100\ 000\ 000$ operations
Max. switching frequency at rated load	360/h
Weight	80 g

**Product References**

**AC 50 Hz / 60 Hz: 24, 48, 115, 230 (240)**

**LED**

**DC: 12, 24, 48, 110, 220**

**LED + Free wheeling diode**

**Railway EN 50155**

**C32L/AC...V**  
**C32/DC...V**  
**C32DL/DC...V**  
**C32D/R DC...V**

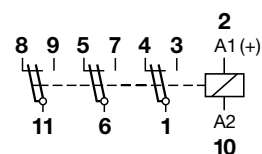
"..." List Coil Voltage to complete Product References

**Accessories**

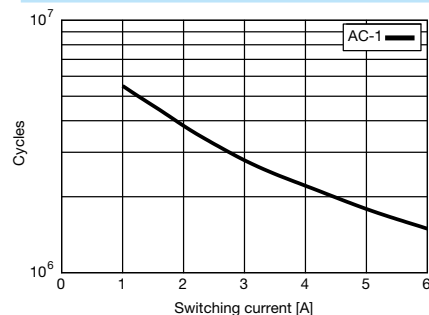
Socket **S3-B, S3-S, S3-PO, S3-M0, S3-M1**  
 Blanking Plug **SO-NP (BAG 10 PCS)**



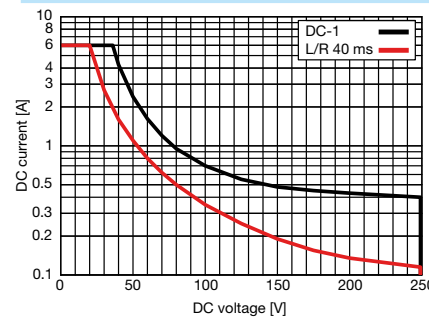
**Connection diagram**



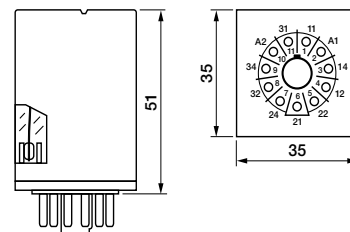
**fig. 1 AC voltage endurance**



**fig. 2 DC load limit curve**



**Dimensions (mm)**



**Technical approvals, conformities**







IEC/EN 61810; IEC/EN 60947; IEC/EN 50155  
 IEC/EN 61373; IEC/EN 45545  
 NF F 16-101/102





## 1.5 Solid State Relays

---

Application	Type	Pin	Page
<b>CSS Series</b>			
1 pole   normally open solid state AC   Faston	CSS-I		74
1 pole   normally open solid state AC   Faston	CSS-Z		75
1 pole   normally open solid state DC   Faston	CSS-N		76
1 pole   normally open solid state DC   Faston	CSS-P		77
<b>CRINT Series</b>			
1 pole   normally open solid state DC	CRINT-1x5	-	78
1 pole   normally open solid state AC	CRINT-1x8	-	79

# CSS-I

## 1 pole | normally open solid state AC | Faston

Output	1 NO
Operating range	3 A, 24 ... 250 V AC, 50/60 Hz
Minimum contact load	35 mA

### Contact

Type	1 NO (Solid state AC)
Material	 Triac
Rated Load	3 A AC

### Control circuit

Input voltage range	5 ... 48 V DC
Input current	10 mA

### Output circuit

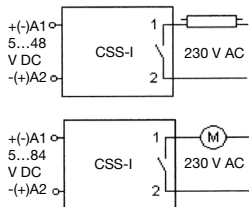
Max. output current	Instantaneous
Min. output current	3 A
Output voltage range	35 mA
Inrush current	24...250 V AC
Residual current	150 A/10 ms
I <sup>2</sup> t value	1 mA
	210 A <sup>2</sup> s

### Specifications

Ambient temperature operation/storage	-40 ... 70 °C / -40 ... 85 °C (no ice)
Pick-up time	0.06 ms
Release time	0.06 ms
Weight	28 g

### Applications

It is specially suitable to switch inductive loads up to 3A/250 V AC. For switching loads with a high inrush or overcurrent as transformers, motors or fluorescents, the maximum output current will limit to 2 A.



### Product References

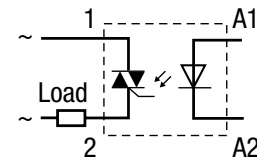
V DC 5-48 **CSS-I12X/DC5-48V**

### Accessories

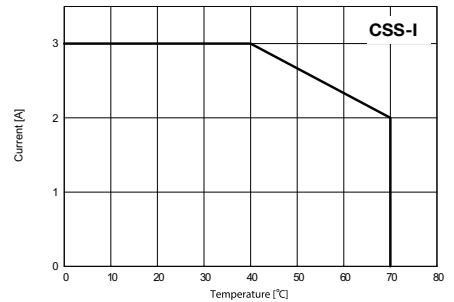
Socket **S10, S10-P**



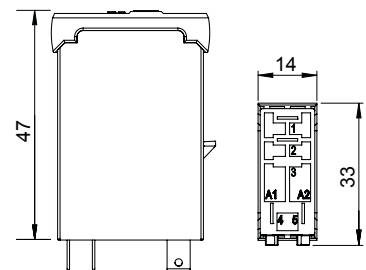
fig. 1 CSS-I diagram



Tab. 2 AC derating curve



### Dimensions (mm)



### Technical approvals, conformities



IEC/EN 60947

# CSS-Z

1 pole | normally open solid state AC | Faston

Output	1 NO
Operating range	3 A, 24 ... 250 V AC, 50/60 Hz
Minimum contact load	35 mA

### Contact

Type	1 NO (Solid state AC)
Material	⚡ Triac
Rated Load	3 A AC

### Control circuit

Input voltage range	5 ... 48 V DC
Input current	10 mA

### Output circuit

Max. output current	Synchronized zero
Min. output current	3 A
Output voltage range	35 mA
Inrush current	24 ... 250 V AC
Residual current	150 A/10 ms
I <sub>t</sub> value	1 mA
	210 A <sup>2</sup> s

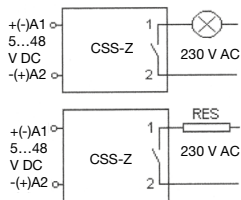
### Specifications

Ambient temperature operation/storage	-40...70 °C / -40 ... 85 °C (no ice)
Pick-up time	10 ms
Release time	10 ms
Weight	28 g

### Applications

Switches ohmic AC loads up to 3 A/250 V AC in the zero-point of the tension and avoids any over-current peak in the connection.

Suitable for switching resistors, incandescent lamps, signalling equipment, etc. Not suitable for inductive loads



### Product References

V DC 5-48

CSS-Z12X/DC5-48V

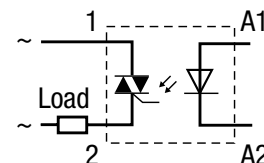
### Accessories

Socket

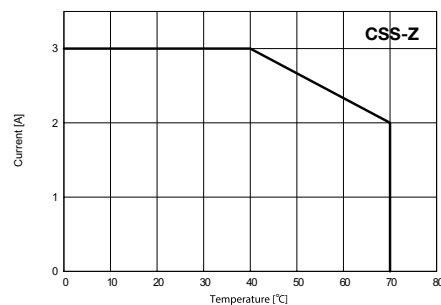
S10, S10-P



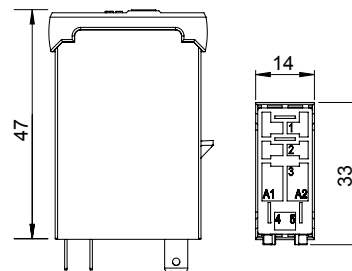
fig. 1 CSS-Z diagram



Tab. 2 AC derating curve



### Dimensions (mm)



### Technical approvals, conformities




IEC/EN 60947

# CSS-N

1 pole | normally open solid state DC | Faston

Output	1 NO
Operating range	6 A, 5 ... 48 V DC
Minimum contact load	1 mA

<b>Contact</b>	
Type	1 NO (Solid state AC)
Material	 Triac
Rated Load	3 A AC

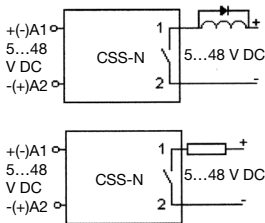
<b>Control circuit</b>	
Input voltage range	5 ... 48 V DC
Input current	4 mA

<b>Output circuit</b>	
Type	NPN
Max. output current	6 A
Output voltage range	5 ... 48 V DC
Max. inrush current	40 A / 10 ms
Max. voltage drop	≤ 0.14 V DC
Residual current	0.1 mA

<b>Specifications</b>	
Ambient temperature operation/storage	-40 ... 70 °C / -40 ... 85 °C (no ice)
Test voltage between input/output	4 kV rms / 1 min.
Turn-on delay	0.06 ms
Release delay	0.06 ms
Weight	28 g

**Applications**  
For switching heating elements, electro valves, motors, PLC input/output signals, solenoids, incandescent and fluorescent lamps, etc. (up to 48 V DC).

**Inductive loads must be shunted with an antiparallel diode.**

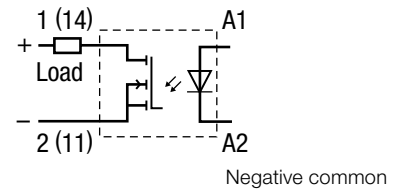


<b>Product References</b>	
V DC 5-48	<b>CSS-N13X/DC5-48V</b>

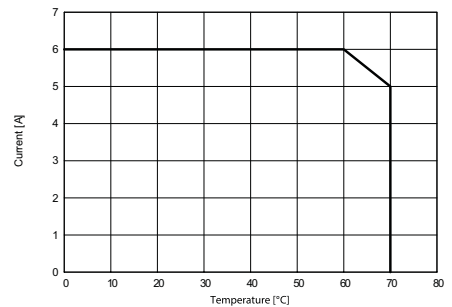
<b>Accessories</b>	
Socket	<b>S10, S10-P</b>



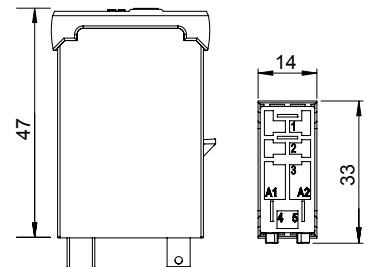
fig. 1 CSS-N diagram



Tab. 2 AC derating curve



Dimensions (mm)



Technical approvals, conformities



IEC/EN 60947

# CSS-P

1 pole | normally open solid state DC | Faston

Output	1 NO
Operating range	6 A, 5 ... 48 V DC
Minimum contact load	1 mA

### Contact

Type	1 NO (Solid state AC)
Material	⚡ Triac
Rated Load	3 A AC

### Control circuit

Input voltage range	5 ... 48 V DC
Input current	4 mA

### Output circuit

Type	PNP
Max. output current	6 A
Output voltage range	5 ... 48 V DC
Max. switch-on current	40 A / 10 ms
Max. voltage drop	0.14 V DC
Residual current	0.1 mA

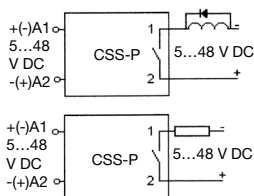
### Specifications

Ambient temperature operation/storage	-40 ... 70 °C / -40 ... 85 °C (no ice)
Turn-on delay	0.06 ms
Release delay	0.06 ms
Weight	28 g

### Applications

For switching heating elements, electro valves, motors, PLC input/output signals, solenoids, incandescent and fluorescent lamps, etc. (up to 48 V DC).

**Inductive loads must be shunted with an antiparallel diode.**



### Product References

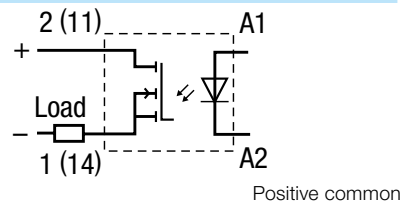
V DC 5-48 **CSS-P13X/DC5-48V**

### Accessories

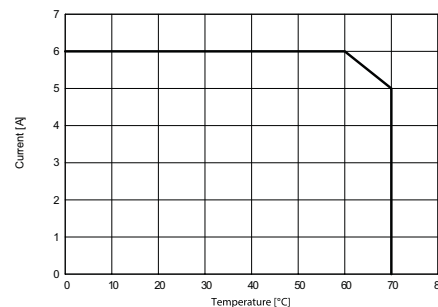
Socket **S10, S10-P**



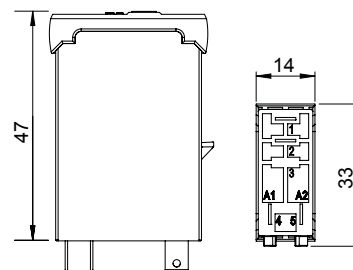
fig. 1 CSS-P diagram



Tab. 2 AC derating curve



### Dimensions (mm)



### Technical approvals, conformities



IEC/EN 60947



<b>Maximum contact load</b>	<b>2 A / 24 V DC-1</b>
<b>Recommended minimum contact load</b>	<b>20 mA / 5 V</b>
<b>Contact</b>	
Type	1 NO (Solid state DC)
Material	Mosfet
Max. inrush current (10ms)	48 A

<b>Coil</b>	
Operation voltage DC	0.8 ... 1.25 U <sub>N</sub>
Nominal power DC	160 mW

<b>Insulation</b>	
Test voltage I / O	2.5 kV rms / 1 min
Pollution degree	3
Over voltage category	III
Open contact Standard	1000 Vrms dielectric strength 1 min EN61810-5

<b>Specifications</b>	
Ambient temperature: operation / storage	-30 ... 70 °C / -40 ... 85 °C (no ice)
Typical response time @ V <sub>n</sub>	1 ms
Typical release time @ V <sub>n</sub>	1 ms
Cond. cross section screw terminal	2.5 mm <sup>2</sup>
Cond. cross section spring cage	0.75 ... 2.5 mm <sup>2</sup>
Protection degree	IP 20
Mounting position	any, TS-35 or Back Panel Mounting
Housing material	Polyamide PA 6

<b>Product References</b>	
Screw terminal	<b>CRINT-C115/DC...V</b>
<b>DC 12V, 24V, 60V, 110-125V, 220-240V</b>	

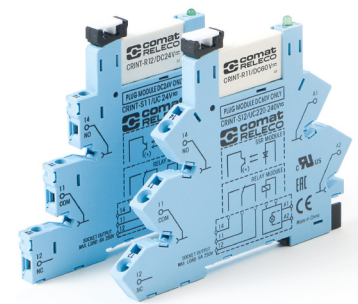
Cage clamp terminal	<b>CRINT-C125/DC...V</b>
<b>DC 12V, 24V, 60V, 110-125V, 220-240V</b>	

<b>Railway EN 50155</b>	<b>CRINT-C125R/DC...V</b>
„...“ List Coil Voltage to complete Product References	

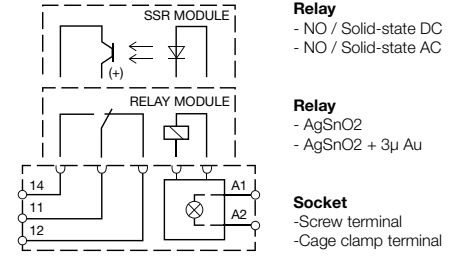
<b>Accessories</b>	
Jumper link	blue: <b>CRINT-BR20-BU (BAG 5 PCS)</b> red: <b>CRINT-BR20-RD (BAG 5 PCS)</b> black: <b>CRINT-BR20-BK (BAG 5 PCS)</b>
Label plate	<b>CRINT-LAB (BAG 4x16 PCS)</b>
Spacer	<b>CRINT-SEP (BAG 5 PCS)</b>

<b>Replacement relays</b>	
<b>DC 12V, 24V, 48V, 60V*</b>	<b>CRINT-R15/DC...V</b>
„...“ List Coil Voltage to complete Product References	

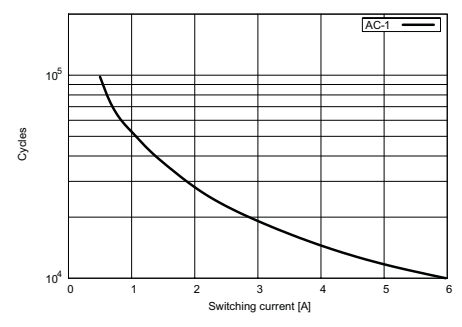
\*60V Relay used for all sockets with a nominal voltage higher or equal 60V



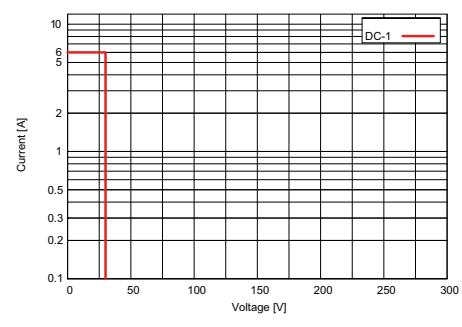
**Connection diagram**



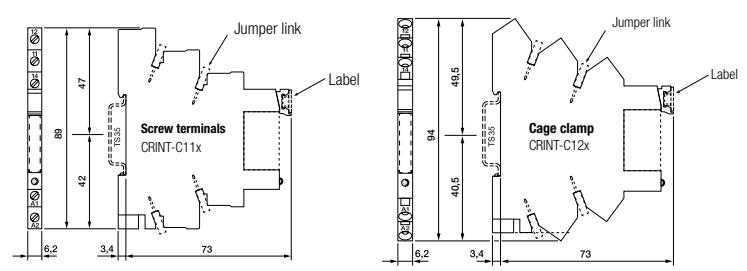
**fig. 1 AC voltage endurance**



**fig. 2 DC load limit curve**



**Dimensions (mm)**



**Technical approvals, conformities**



IEC/EN 61810, IEC/EN 50155, IEC/EN 45545



<b>Maximum contact load</b>	<b>2 A</b>
<b>Recommended minimum contact load</b>	<b>20 mA / 5 V</b>
<b>Contact</b>	
Type	1 NO (Solid state AC)
Material	⚡ Triac
Max. inrush current (10 ms)	80 A

<b>Coil</b>	
Operation voltage DC	0.8 ... 1.25 U <sub>N</sub>
Nominal power DC	150 mW

<b>Insulation</b>	
Test voltage I / O	2.5 kV rms / 1 min
Pollution degree	3
Over voltage category	III
Open contact	1000 Vrms dielectric strength 1 min
Standard	EN61810-5

<b>Specifications</b>	
Ambient temperature: operation / storage	-30 ... 70 °C / -40 ... 85 °C (no ice)
Typical response time @ V <sub>n</sub>	1 ms
Typical release time @ V <sub>n</sub>	1 ms
Cond. cross section screw terminal	2.5 mm <sup>2</sup>
Cond. cross section spring cage	0.75 ... 2.5 mm <sup>2</sup>
Protection degree	IP 20
Mounting position	any, TS-35 or Back Panel Mounting
Housing material	Polyamide PA 6

**Product References**

Screw terminal  
**DC 12V, 24V, 60V, 110-125V, 220-240V**      **CRINT-C118/DC...V**

Cage clamp terminal  
**DC 12V, 24V, 60V, 110-125V, 220-240V**      **CRINT-C128/DC...V**

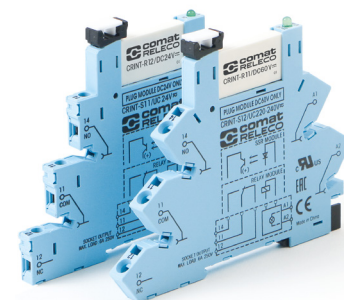
**Railway EN 50155**  
 "...“ List Coil Voltage to complete  
 Product References      **CRINT-C128R/DC...V**

<b>Accessories</b>	
Jumper link	blue: <b>CRINT-BR20-BU (BAG 5 PCS)</b> red: <b>CRINT-BR20-RD (BAG 5 PCS)</b> black: <b>CRINT-BR20-BK (BAG 5 PCS)</b>
Label plate	<b>CRINT-LAB (BAG 4x16 PCS)</b>
Spacer	<b>CRINT-SEP (BAG 5 PCS)</b>

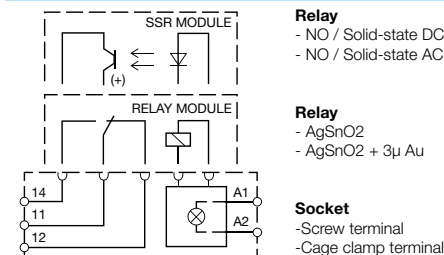
**Replacement relays**  
**DC 12V, 24V, 60V\***      **CRINT-R18/DC...V**

"..." List Coil Voltage to complete  
 Product References

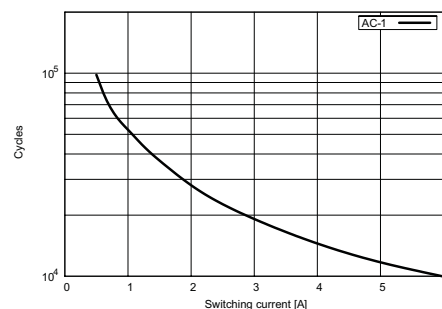
\*60V Relay used for all sockets with a nominal voltage higher or equal 60V



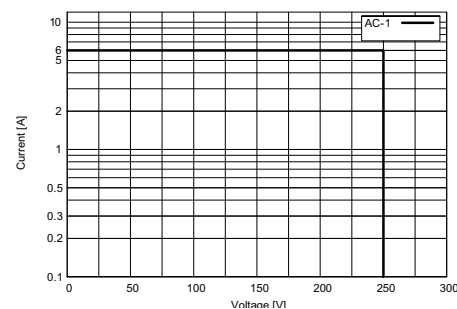
**Connection diagram**



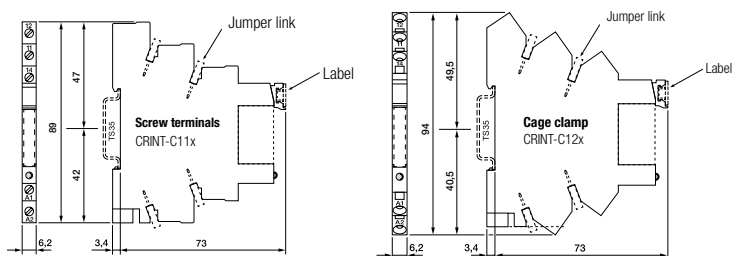
**fig. 1 AC voltage endurance**



**fig. 2 DC load limit curve**



**Dimensions (mm)**



**Technical approvals, conformities**



IEC/EN 61810, IEC/EN 50155, IEC/EN 45545





## 1.6 Installation Relays

---

Application	Type	Page
<b>CHI Series</b>		
1 pole   High Inrush Relay	CHI14	82
3 pole   High Inrush Relay	CHI34	83
<b>C100/200/300 Series</b>		
2 pole   Power Relay	C133.01	84
2 pole   2 Coil   Control Relay	C203.01	85
2 pole   2 Coil   Control Relay	C203.04	86
2 pole   2 Coil   Signal Relay	C203.06	87
3 pole   3 Coil   Signal Relay	C301.04	88
<b>CR Series</b>		
2 pole   Signal Relay	CR11C	89
1 pole   Power Relay	CR16CX	90
1 pole   Power Relay   Step Switch	CRS1C	91
<b>B Series</b>		
1 pole   Power Relay	B103	92

# CHI14

## 1 pole | High Inrush Relay

<b>Maximum contact load</b>	<b>16 A / 250 V AC-1</b>
<b>Recommended minimum contact load</b>	<b>100 mA / 12 V</b>

### Contacts

Number of contacts	1
Material	W / AgSnO <sub>2</sub>
Max. inrush current (20 ms)	165 A
(200 μs)	800 A / 200
Max. switching voltage AC-1	250 V
Max. AC load AC-1 fig. 1	4 kVA

### Power supply- and control input

Nominal voltage (A1, B1)	<b>UC 24-240 V (UC = AC / DC)</b>
Operating voltage range	16.8 ... 250 V
Power consumption	1.2 VA / 0.43 W
Frequency range	16 ... 60 Hz

### Insulation

Test voltage open contact	1 kV rms / 1 min
Test voltage between contacts and control input	2.5 kV rms / 1 min

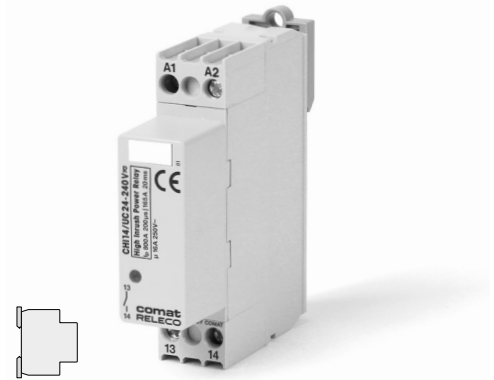
### General Specifications

Ambient temperature storage /operation	-40 ... 85 °C / -40 ...60 °C (no ice)
Mechanical life of contact	5 x 1 000 000 operations
Conductor cross section	Stranded wire 2.5 mm <sup>2</sup> , 2 x 1.5 mm <sup>2</sup>
Protection degree	IP 20
Nominal screw torque	0.4 Nm
Housing material	Lexan
Weight	70 g

### Product References

UC (AC/DC) 15...60 Hz

**CHI14/UC24-240V**



Connection diagram

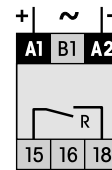


fig. 1 AC voltage endurance

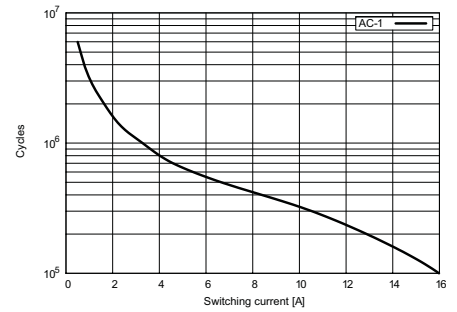
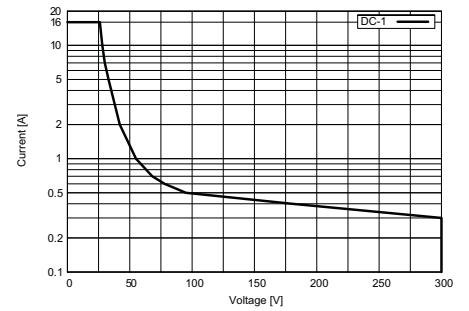
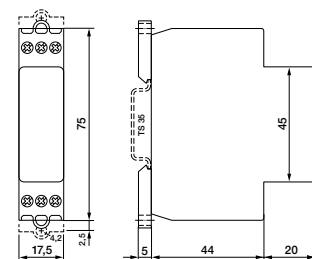


fig. 2 DC load limit curve



### Dimensions (mm)



### Technical approvals, conformities




# CHI34

## 3 pole | High Inrush Relay

**Maximum contact load** 16 A / 250 V AC-1  
**Recommended minimum contact load** 100 mA / 12 V

### Contacts

Number of contacts 3  
 Material  W / AgSnO<sub>2</sub>  
 Max. inrush current (20 ms) 165 A  
 (200 μs) 800 A  
 Max. switching voltage AC-1 250 V  
 Max. AC load AC-1 fig. 1 4 kVA

### Auxiliary Contacts

Number of contacts 1  
 Nominal current at 25°C/60°C 90 mA/60 mA  
 Inrush current 1 A/100 μs  
 Nominal voltage AC/DC 24 V  
 Contact Material Semiconductor

### Supply U<sub>B</sub> (1-N)

Nominal operating voltage (AC/DC) 110...240 V  
 Operating voltage (AC/DC) 80...250 V  
 Frequency range 47...63 Hz  
 Power consumption 3.45 VA

### Power supply- and control input

Nominal voltage (A1, A2) **UC 24-240 V (UC = AC / DC)**  
 Operating voltage range 16.8 ... 250 V  
 Power consumption 30 VA / 30 mW  
 Frequency range 47...63 Hz

### Insulation

Test voltage open contact 1 kV rms / 1 min  
 Test voltage between contacts and control input 2.5 kV rms / 1 min  
 Test voltage between contacts 2.5 kV rms / 1 min

### General Specifications

Ambient temperature storage /operation -40 ... 85 °C / -25 ...60 °C (no ice)  
 Mechanical life of contact 5 x 1 000 000 operations  
 Conductor cross section Stranded wire 2.5 mm<sup>2</sup>, 2 x 1.5 mm<sup>2</sup>  
 Protection degree IP 20  
 Nominal screw torque 0.6 Nm  
 Housing material Lexan  
 Weight 125 g

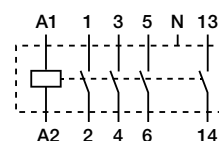
### Product References

**UC (AC/DC) 47...63 Hz**

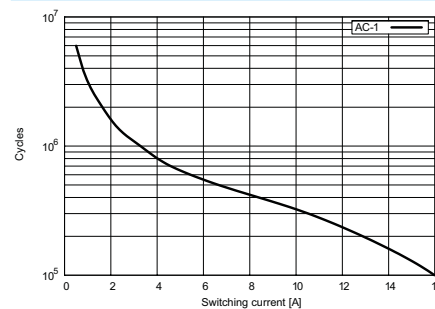
**CHI34/UC24-240V**



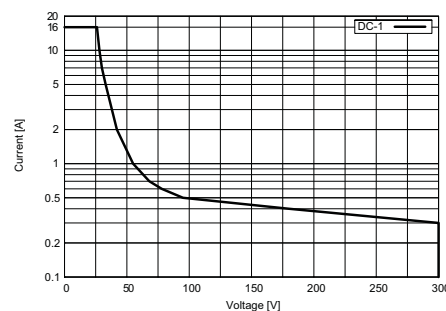
**Connection diagram**



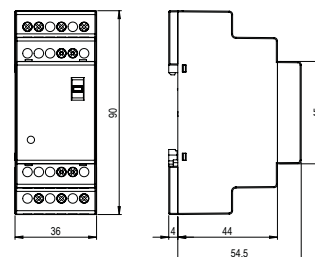
**fig. 1 AC voltage endurance**



**fig. 2 DC load limit curve**



**Dimensions (mm)**



**Technical approvals, conformities**

EN 61000-6-3; EN 61000-6-2

# C133.01

## 2 pole | Power Relay



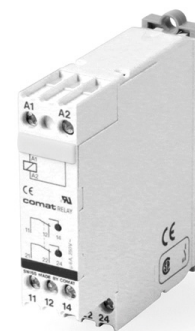
<b>Maximum contact load</b>	<b>6 A / 250 V AC-1</b>
<b>Recommended minimum contact load</b>	<b>100 mA / 12 V</b>
<b>Contacts</b>	
Type	2 CO
Material	⚡ AgNi
Max. inrush current (20 ms)	15 A
<b>Coil</b>	
Operation voltage AC 50/60 Hz / DC	0.85 ... 1.15 U <sub>N</sub>
Nominal power DC / AC	1.1 W / 1.1 VA
<b>Insulation</b>	
Test voltage I / O	2000 Vrms / 1min
Pollution degree	3
Over voltage category	III
Open contact	1000 Vrms
Standard	EN61810-1
<b>Specifications</b>	
Ambient temperature: operation / storage	-20 ... 55 °C / -40 ... 85 °C (no ice)
Typical response time @ V <sub>n</sub>	10 ms
Typical release time @ V <sub>n</sub>	10 ms
Cond. cross section screw terminal	2.5 mm <sup>2</sup>
Protection degree	IP 20
Mounting position	any
Weight	89 g

### Product References

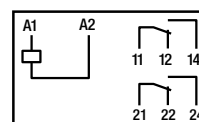
**AC220-240V, DC12V, UC24V, UC48V**

**C133.01/...V**

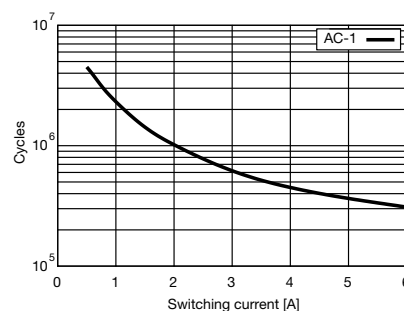
"..." List Coil Voltage to complete Product References



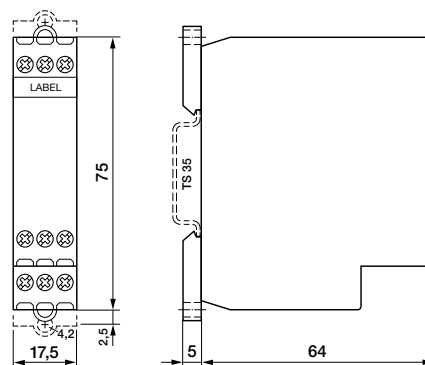
### Connection diagram



**fig. 1 AC voltage endurance**



### Dimensions (mm)



### Technical approvals, conformities



EN 61810

## C203.01

### 2 pole | 2 Coil | Control Relay

<b>Maximum contact load</b>	<b>6 A / 250 V AC-1</b>	<b>6 A 25 V DC-1</b>
<b>Recommended minimum contact load</b>	<b>100 mA / 12 V</b>	

#### Contacts

Type	2 x 1 CO
Material	AgNi
Max. inrush current (20 ms)	15 A

#### Coil

Operation voltage AC 50/60 Hz / DC	0.85 ... 1.15 U <sub>N</sub>
Nominal power DC/AC	1.1 W / 1.1 VA

#### Insulation

Test voltage I / O	2000 Vrms / 1min
Pollution degree	3
Over voltage category	III
Open contact	1000 Vrms
Standard	EN61810-1

#### Specifications

Ambient temperature: operation / storage	-20 ... 55 °C / -40 ... 85 °C (no ice)
Typical response time @ V <sub>n</sub>	10 ms
Typical release time @ V <sub>n</sub>	10 ms
Cond. cross section screw terminal	2.5 mm <sup>2</sup>
Protection degree	IP 20
Mounting position	any
Weight	89 g

#### Product References

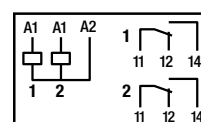
**AC220-240V, UC24V**

**C203.01/...V**

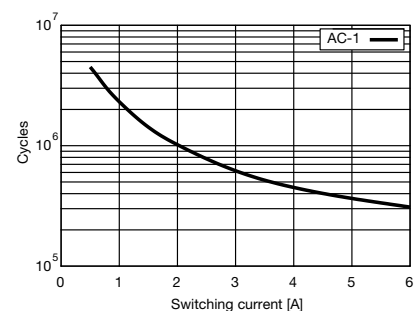
"..." List Coil Voltage to complete Product References



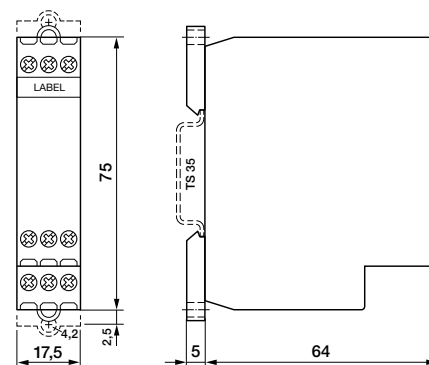
#### Connection diagram



**fig. 1 AC voltage endurance 250 V**



#### Dimensions (mm)



#### Technical approvals, conformities



EN 61810

**C203.04**

**2 pole | 2 Coil | Control Relay**

<b>Maximum contact load</b>	<b>5 A / 250 V AC-1</b>	<b>5 A 30 V DC-1</b>
<b>Recommended minimum contact load</b>	<b>1 mA / 0.1 V</b>	

**Contacts**

Type	2 CO
Material	Ag Alloy
Max. inrush current	-

**Coil**

Operation voltage DC	0.8 ... 1.2 U <sub>N</sub>
Nominal power DC	2 x 0.25 W

**Insulation**

Test voltage I / O	2000 Vrms / 1min
Pollution degree	3
Over voltage category	III
Open contact	1000 Vrms
Standard	EN61810-1

**Specifications**

Ambient temperature: operation / storage	-20 ... 55 °C / -40 ... 85 °C (no ice)
Typical response time @ V <sub>n</sub>	6 ms
Typical release time @ V <sub>n</sub>	30 ms
Cond. cross section screw terminal	2.5 mm <sup>2</sup>
Protection degree	IP 20
Mounting position	any
Weight	65 g

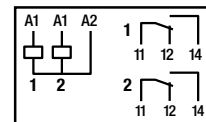
**Product References**

**DC24V** C203.04...V

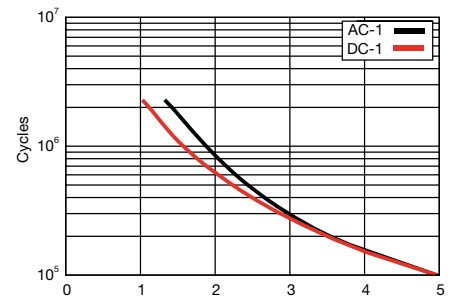
"..." List Coil Voltage to complete Product References



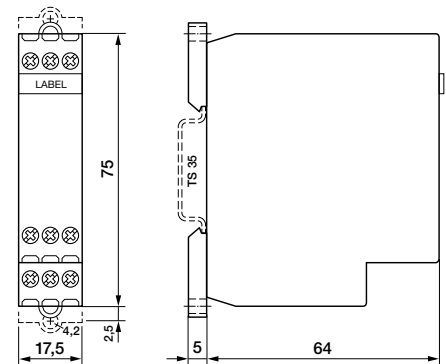
**Connection diagram**



**fig. 1 Contact endurance**



**Dimensions (mm)**



**Technical approvals, conformities**



EN 61810

## C203.06

### 2 pole | 2 Coil | Signal Relay

<b>Maximum contact load</b>	<b>0.5 A / 125 V AC-1</b>	<b>2 A 30 V DC-1</b>
<b>Recommended minimum contact load</b>	<b>10 µA / 10 mV</b>	

#### Contacts

Type	2 x 1 CO
Material	AgAu
Max. inrush current	-

#### Coil

Operation voltage DC	0.8 ... 1.2 U <sub>N</sub>
Nominal power DC	2 x 0.25 W

#### Insulation

Test voltage I / O	2000 Vrms / 1min
Pollution degree	3
Over voltage category	III
Open contact	1000 Vrms
Standard	EN61810-1

#### Specifications

Ambient temperature: operation / storage	-20 ... 55 °C / -40 ... 85 °C (no ice)
Typical response time @ V <sub>n</sub>	10 ms
Typical release time @ V <sub>n</sub>	20 ms
Cond. cross section screw terminal	2.5 mm <sup>2</sup>
Protection degree	IP 20
Mounting position	any
Weight	65 g

#### Product References

**AC220-240V, UC24V, UC48V  
UC24V**

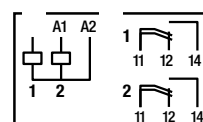
„...“ List Coil Voltage to complete  
Product References

**C203.06/...V**

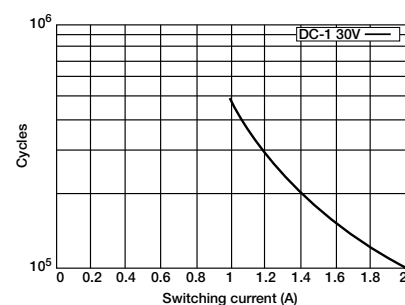
**C203.06R/...V**



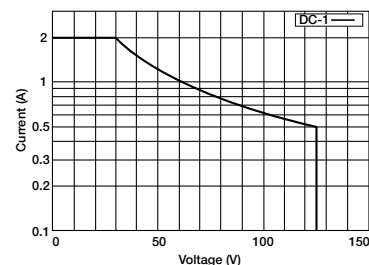
#### Connection diagram



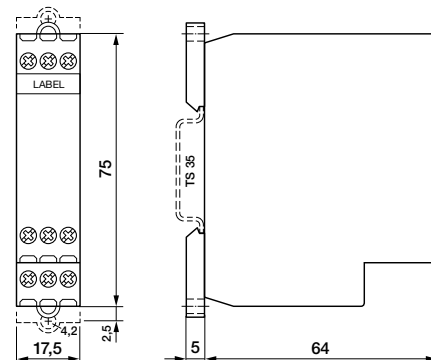
**fig. 1 DC Voltage Endurance**



**fig. 2 DC load limit curve**



#### Dimensions (mm)



#### Technical approvals, conformities



EN 61810

**C301.04**

**3 pole | 3 Coil | Signal Relay**

<b>Maximum contact load</b>	<b>5 A / 250 V AC-1</b>	<b>5 A 30 V DC-1</b>
<b>Recommended minimum contact load</b>	<b>1 mA / 0.1 V</b>	

**Contacts**

Type	3 x 1 NO
Material	Ag Alloy
Max. inrush current	-

**Coil**

Operation voltage DC	0.8 ... 1.2 U <sub>N</sub>
Nominal power DC	3 x 0.25 W

**Insulation**

Test voltage I / O	2000 Vrms / 1min
Pollution degree	3
Over voltage category	III
Open contact	1000 Vrms
Standard	EN61810-1

**Specifications**

Ambient temperature: operation / storage	-20 ... 55 °C / -40 ... 85 °C (no ice)
Typical response time @ V <sub>n</sub>	6 ms
Typical release time @ V <sub>n</sub>	30 ms
Cond. cross section screw terminal	2.5 mm <sup>2</sup>
Protection degree	IP 20
Mounting position	any
Weight	65 g

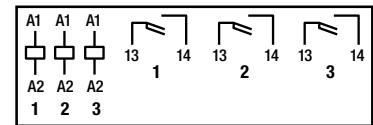
**Product References**

**DC24V** C301.04...V

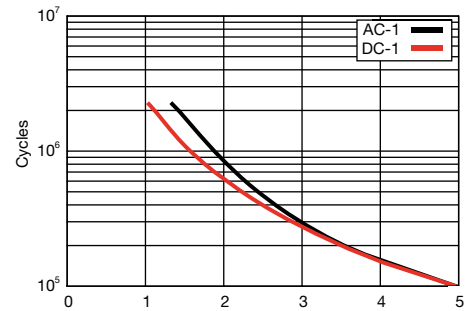
"..." List Coil Voltage to complete Product References



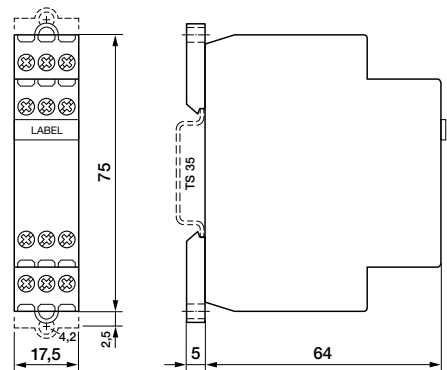
**Connection diagram**



**fig. 1 Contact endurance**



**Dimensions (mm)**



**Technical approvals, conformities**



EN 61810



# CR11C

## 2 pole | Signal Relay

<b>Maximum contact load</b>	<b>0.5 A / 125 V AC-1</b>	<b>1 A 30 V DC-1</b>
<b>Recommended minimum contact load</b>	<b>10 µA / 10 mV</b>	

### Contacts

Type	2 CO
Material	AgAu
Max. inrush current	-

### Coil

Operation voltage DC	0.8 ... 1.2 U <sub>N</sub>
Nominal power DC	0.25 W

### Insulation

Test voltage I / O	2000 Vrms / 1min
Pollution degree	3
Over voltage category	III
Open contact	1000 Vrms
Standard	EN61810-1

### Specifications

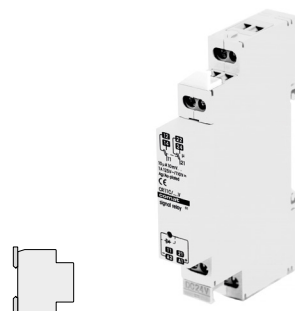
Ambient temperature: operation / storage	-20 ... 55 °C / -40 ... 85 °C (no ice)
Typical response time @ V <sub>n</sub>	3 ms
Typical release time @ V <sub>n</sub>	4 ms
Cond. cross section screw terminal	2.5 mm <sup>2</sup>
Protection degree	IP 20
Mounting position	any
Weight	38 g

### Product References

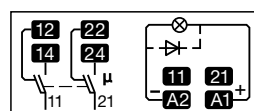
#### DC24V

**CR11C/...V**

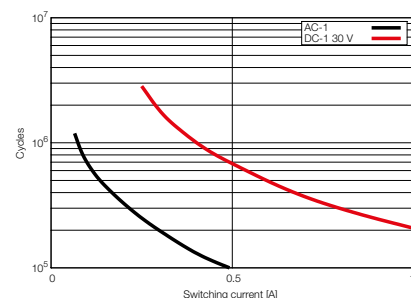
"..." List Coil Voltage to complete Product References



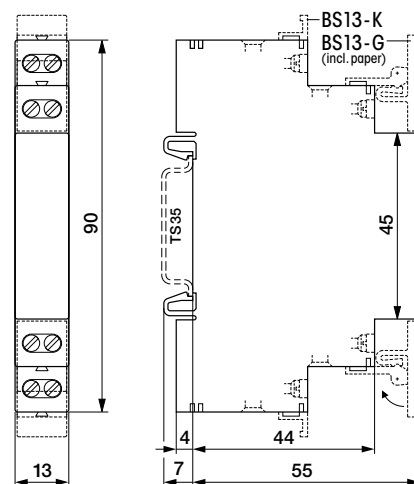
**Connection diagram**



**fig. 1 Contact endurance**



### Dimension



### Technical approvals, conformities



EN 61810

**CR16CX**

**1 pole | Power Relay**

<b>Maximum contact load</b>	<b>6 A / 250 V AC-1</b>	<b>6 A 30 V DC-1</b>
<b>Recommended minimum contact load</b>	<b>10 mA / 12 V</b>	

**Contacts**

Type	1 CO
Material	⚡ AgNi
Max. inrush current	-

**Coil**

Operation voltage AC / DC	0.8 ... 1.1 U <sub>N</sub> / 0.85 ... 1.15 U <sub>N</sub>
Nominal power AC / DC	2.5 VA / 0.25 W

**Insulation**

Test voltage I / O	2000 Vrms / 1min
Pollution degree	3
Over voltage category	III
Open contact	1000 Vrms
Standard	EN61810-1

**Specifications**

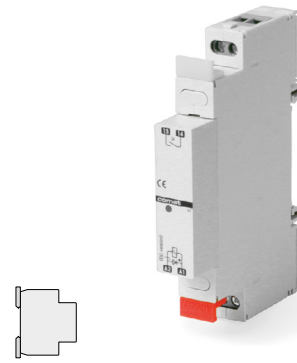
Ambient temperature: operation / storage	-20 ... +60 °C / -40 ... 85 °C (no ice)
Typical response time @ V <sub>n</sub>	10 ms
Typical release time @ V <sub>n</sub>	20 ms
Cond. cross section screw terminal	2.5 mm <sup>2</sup>
Protection degree	IP 20
Mounting position	any
Weight	45 g

**Product References**

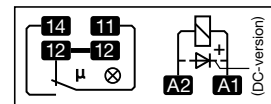
**DC24V, AC230V**

**CR16CX/...V**

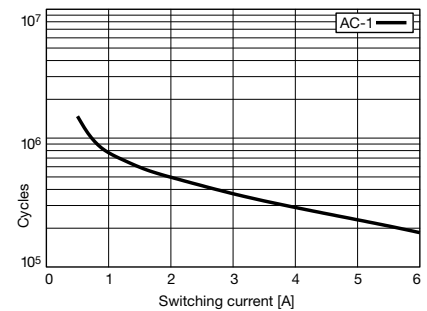
"..." List Coil Voltage to complete Product References



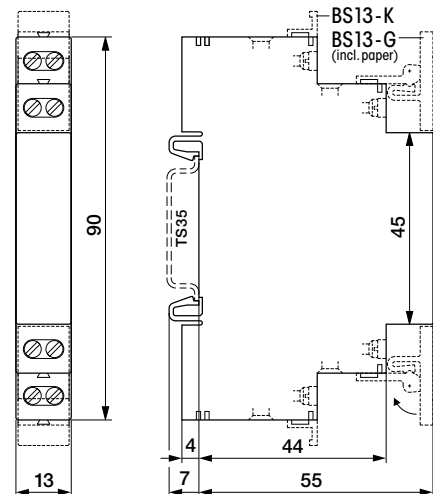
**Connection diagram**



**fig. 1 AC voltage endurance 250 V**



**Dimensions (mm)**



**Technical approvals, conformities**



IEC 61810

# CRS1C

## 1 pole | Power Relay | Step Switch

<b>Maximum contact load</b>	<b>6 A / 250 V AC-1</b>	<b>6 A 30 V DC-1</b>
<b>Recommended minimum contact load</b>	<b>10 mA / 12 V</b>	

### Contacts

Type	1 CO
Material	⚡ AgNi
Max. inrush current	-

### Coil

Operation voltage AC / DC	0.85 ... 1.15 U <sub>N</sub> / 0.85 ... 1.15 U <sub>N</sub>
Nominal power AC / DC	2 VA / 1.5 W

### Insulation

Test voltage I / O	2000 Vrms / 1min
Pollution degree	3
Over voltage category	III
Open contact	1000 Vrms
Standard	EN61810-1

### Specifications

Ambient temperature: operation / storage	-20 ... +60 °C / -40 ... 85 °C (no ice)
Typical response time @ V <sub>n</sub>	≥ 50 ms
Typical release time @ V <sub>n</sub>	≥ 50 ms
Cond. cross section screw terminal	2.5 mm <sup>2</sup>
Protection degree	IP 20
Mounting position	any
Weight	45 g

### Product References

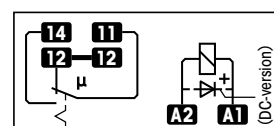
**DC24V, AC230V**

**CRS1C/...V**

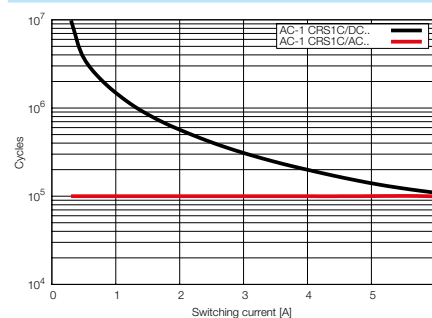
"..." List Coil Voltage to complete Product References



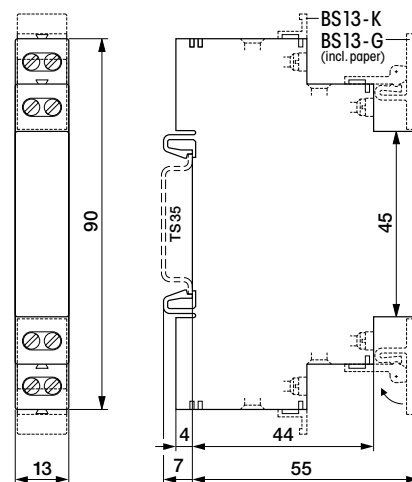
### Connection diagram



**fig. 1 AC voltage endurance 250 V**



### Dimension



### Technical approvals, conformities



IEC 61810

**B103**

**1 pole | Power Relay**

<b>Maximum contact load</b>	<b>10 A / 250 V AC-1</b>	<b>6 A 30 V DC-1</b>
<b>Recommended minimum contact load</b>	<b>10 mA / 12 V</b>	

**Contacts**

Type	1 CO
Material	⚡ AgSnO <sub>2</sub>
Max. inrush current (20 ms)	16 A

**Coil**

Operation voltage AC / DC	0.85 ... 1.15 U <sub>N</sub> / 0.85 ... 1.15 U <sub>N</sub>
Nominal power AC / DC	0.5 ... 5.5 VA / 1.2 W

**Insulation**

Test voltage I / O	2000 Vrms / 1min
Pollution degree	3
Over voltage category	III
Open contact	1000 Vrms
Standard	EN61810-1

**Specifications**

Ambient temperature: operation / storage	-20 ... 55 °C / -40 ... 85 °C (no ice)
Typical response time @ V <sub>n</sub>	20 ms
Typical release time @ V <sub>n</sub>	12 ms
Cond. cross section screw terminal	2.5 mm <sup>2</sup>
Protection degree	IP 20
Mounting position	any
Weight	60 g

**Product References**

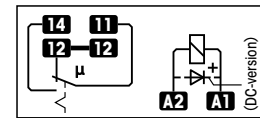
**AC220-240V, UC8-12V, UC24V**

**B103/...V**

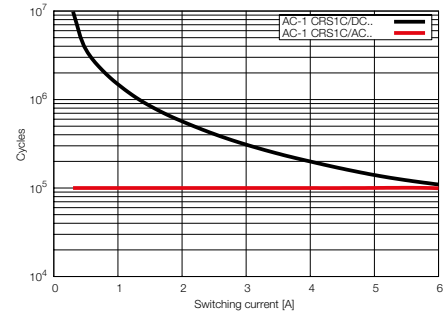
"..." List Coil Voltage to complete Product References



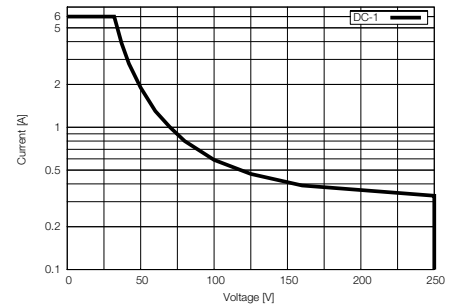
**Connection diagram**



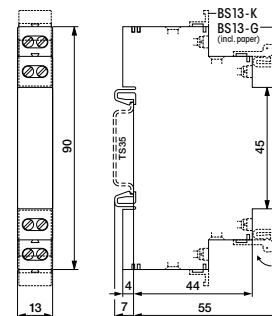
**fig. 1 AC voltage endurance 250 V**



**fig. 2 DC load limit curve**



**Dimensions (mm)**



**Technical approvals, conformities**



IEC 61810

## 1.7 Installation Contactors

Application	Type	Page
<b>RIC Series</b>		
Installation Contactor   1, 2 or 4 pole   16 A   3.5 kW	RIC16	94
Installation Contactor   2 pole   20 A   4 kW	RIC20	95
Installation Contactor   2 pole   20 A   7 kW   Railway	RIC20-xxx-R4A	96
Installation Contactor   2 or 4 pole   25 A   5.4 kW	RIC25	97
Installation Contactor   2 or 4 pole   32 A   7 kW	RIC32	98
Installation Contactor   4 pole   40 A   8.7 kW	RIC40	99
Installation Contactor   4 pole   63 A   13.3 kW	RIC63	100
<b>RAC Series</b> – manual lever Auto – 1 – Lock		
Installation Contactor   2 pole   20 A   4 kW	RAC20	101
Installation Contactor   2 pole   25 A   5.4 kW	RAC25	102
Installation Contactor   4 pole   40 A   8.7 kW	RAC40	103
Installation Contactor   4 pole   63 A   13.3 kW	RAC63	104
<b>RBC Series</b> – Step switch – manual lever 0 – 1 – Lock		
Installation Contactor   2 or 4 pole   20 A   4.4 kW	RBC20	105
Installation Contactor   4 pole   32 A   7 kW	RBC32	106
<b>Accessories</b>		
Auxiliary module   2 pole   6 A	RIC-AUX	107
Auxiliary module   2 pole   6 A	RBC-AUX	108
Auxiliary centralized control   On – Off	RBC-AUX-CM	109
Auxiliary group control   On – Off	RBC-AUX-GM	110
Spacer	RIC-DIST	111
Sealing cover	RIC-SEAL	112

# RIC16

## Installation Contactor | 1, 2 or 4 pole | 16 A | 3.5kW

### Main circuit

Contact material	AgNi
Rated voltage	400 V
Rated current AC-1	16 A
Minimum contact load	50 mA, 17 V
Inrush current	50 A, 100 ms
Rated load AC-1, 230 V	3.5 kW
Rated load AC-3, 230 V	1.1 kW (NO) / 0.55 kW (NC)
Rated load DC-1, DC-3, DC-5	fig. 2
Mechanical endurance (cycles)	$\geq 1 \times 10^7$
Electrical endurance at rated load AC-1 (cycles)	$\geq 2 \times 10^5$
Electrical endurance at rated load AC-3 (cycles)	$\geq 3 \times 10^5$
Electrical endurance at rated load DC-1 (cycles)	$\geq 1 \times 10^5$
Switching frequency at rated load AC-1 (cycles/h)	$\leq 600$
Switching frequency at rated load AC-3 (cycles/h)	$\leq 600$
Switching frequency at rated load DC-1 (cycles/h)	$\leq 300$

### Control circuit

Nominal voltage	230 V UC
Operating voltage range	0.85 ... 1.1 $U_N$
Typ. pick-up voltage	$\leq 0.85 U_N$
Typ. release voltage	$\geq 0.1 U_N$
Pick-up time	15 ... 45 ms
Release time	20 ... 50 ms
Power consumption AC / DC	2.1 VA / 2.1 W
Rated frequency	40 ... 500 Hz

### Insulation

Rated insulation voltage	440 V
Rated impulse withstand voltage open contact	4 kV
Pollution degree	3
Overvoltage category	III
Clearance of open contact	3.6 mm

### General data

Ambient temperature storage	-30 ... 80 °C
Ambient temperature operation 2 Device / 1 Spacer	-15 ... 55 °C
Ambient temperature operation 3 Device / 1 Spacer	-15 ... 40 °C
Conductor cross section Control / Main Circuit	2.5 mm <sup>2</sup> / 6 mm <sup>2</sup>
Nominal screw torque Control / Main Circuit	0.6 Nm / 3.5 Nm
Module width	fig. 3
Weight	130 g (1, 2 pole) / 170 g (4 pole)
Protection degree	IP 20
Housing material	PA 6

### Product references

Main circuit	Product reference	230
1 NO	RIC16-100/UC...V	✓
1 NC	RIC16-010/UC...V	✓
1 NO + 1 NC	RIC16-110/UC...V	✓
2 NO	RIC16-200/UC...V	✓
2 NC	RIC16-020/UC...V	✓
2 NO + 2 NC	RIC16-220/UC...V	✓
3 NO + 1 NC	RIC16-310/UC...V	✓
4 NO	RIC16-400/UC...V	✓
4 NC	RIC16-040/UC...V	✓

"..." list control circuit voltage to complete product references.  
Other voltages on request. Please contact support@comatreleco.com.

### Accessories

Sealing cover	RIC-SEAL20 / RIC-SEAL25
Spacer	RIC-DIST



fig. 1. Wiring diagram

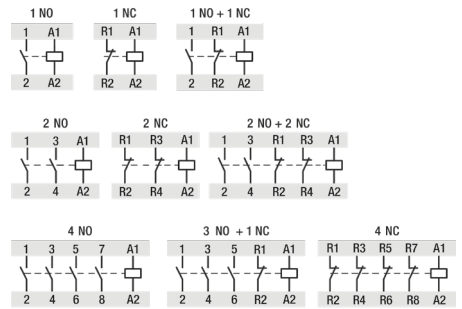


fig. 2. DC load limit curve

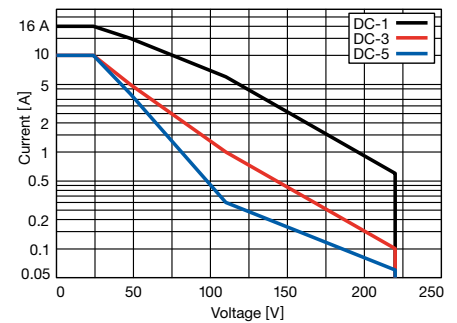
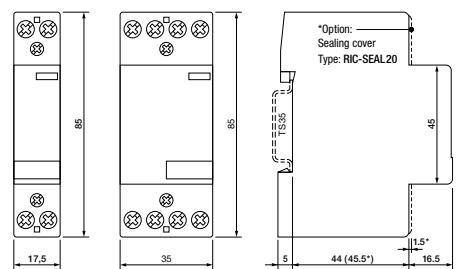


fig. 3. Dimensions (mm)



### Standards and approvals

Standards IEC/EN 60947, IEC/EN 61095

Approvals

# RIC20

## Installation Contactor | 2 pole | 20 A | 4 kW

### Main circuit

Contact material	AgNi
Rated voltage	400 V
Rated current AC-1	20 A
Minimum contact load	50 mA, 17 V
Inrush current	50 A, 100 ms / 180 A, 300 μs
Rated load AC-1, 230 V	4 kW
Rated load AC-3, 230 V	1.3 kW (NO) / 0.75 kW (NC)
Rated load DC-1, DC-3, DC-5	fig. 2
Mechanical endurance (cycles)	≥ 1 × 10 <sup>7</sup>
Electrical endurance at rated load AC-1 (cycles)	≥ 2 × 10 <sup>5</sup>
Electrical endurance at rated load AC-3 (cycles)	≥ 3 × 10 <sup>5</sup>
Electrical endurance at rated load DC-1 (cycles)	≥ 1 × 10 <sup>5</sup>
Switching frequency at rated load AC-1 (cycles/h)	≤ 600
Switching frequency at rated load AC-3 (cycles/h)	≤ 600
Switching frequency at rated load DC-1 (cycles/h)	≤ 300

### Control circuit

Nominal voltage	24V UC, 36 V UC, 110 V UC, 230 V UC
Operating voltage range	0.85 ... 1.1 U <sub>N</sub>
Typ. pick-up voltage	≤ 0.85 U <sub>N</sub>
Typ. release voltage	≥ 0.1 U <sub>N</sub>
Pick-up time	15 ... 45 ms
Release time	20 ... 50 ms
Power consumption AC / DC	2.1 VA / 2.1 W
Rated frequency	40 ... 500 Hz

### Insulation

Rated insulation voltage	440 V
Rated impulse withstand voltage open contact	4 kV
Pollution degree	3
Overvoltage category	III
Clearance of open contact	3.6 mm

### General data

Ambient temperature storage	-30 ... 80 °C
Ambient temperature operation 2 Device / 1 Spacer	-15 ... 55 °C
Ambient temperature operation 3 Device / 1 Spacer	-15 ... 40 °C
Conductor cross section Control / Main Circuit	2.5 mm <sup>2</sup> / 6 mm <sup>2</sup>
Nominal screw torque Control / Main Circuit	0.6 Nm / 1.2 Nm
Module width	fig. 3
Weight	130 g
Protection degree	IP 20
Housing material	PA 6

### Product references

Main circuit	Product reference	24	36	110	230
2 NO	RIC20-200/UC...V	✓	✓	✓	✓
2 NC	RIC20-020/UC...V	✓	✓		✓
1 NO + 1 NC	RIC20-110/UC...V	✓	✓		✓

"..." list control circuit voltage to complete product references.  
Other voltages on request. Please contact support@comatreleco.com.

### Accessories

Sealing cover	RIC-SEAL20
Spacer	RIC-DIST

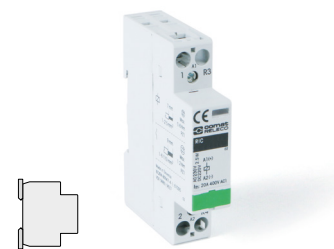


fig. 1. Wiring diagram

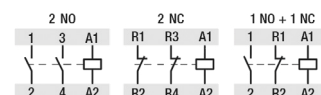


fig. 2. DC load limit curve

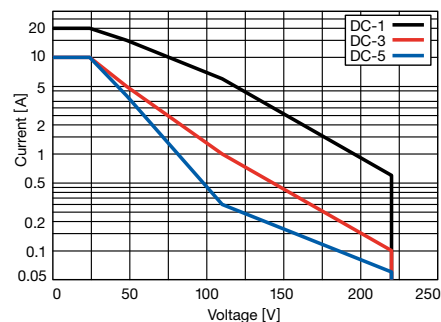
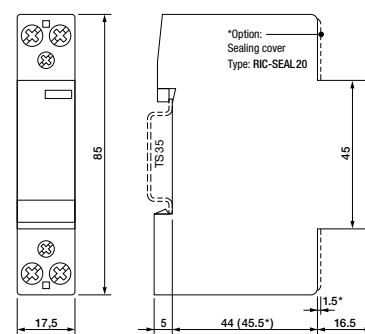


fig. 3. Dimensions (mm)



### Standards and approvals

Standards IEC/EN 60947, IEC/EN 61095

Approvals



**RIC20-xxx-R4A110V**

**Installation Contactor | 2 pole | 20 A | 7 kW**



**Main circuit**

Contact material	AgNi
Rated voltage	400 V
Rated current AC-1	20 A
Minimum contact load	50 mA, 17 V
Inrush current	50 A, 100 ms / 180 A, 300 μs
Rated load AC-1, 230 V	7 kW
Rated load AC-3, 230 V	1.3 kW (NO) / 0.75 kW (NC)
Rated load DC-1, DC-3, DC-5	fig. 2
Mechanical endurance (cycles)	≥ 1 x 10 <sup>7</sup>
Electrical endurance at rated load AC-1 (cycles)	≥ 1.5 x 10 <sup>5</sup>
Electrical endurance at rated load AC-3 (cycles)	≥ 2 x 10 <sup>5</sup>
Electrical endurance at rated load DC-1 (cycles)	≥ 2 x 10 <sup>5</sup>
Electrical endurance at rated load DC-5 (cycles)	≥ 3 x 10 <sup>5</sup>
Switching frequency at rated load AC-1 (cycles/h)	≤ 600
Switching frequency at rated load AC-3 (cycles/h)	≤ 600
Switching frequency at rated load DC-3 (cycles/h)	≤ 300
Switching frequency at rated load DC-5 (cycles/h)	≤ 300

**Control circuit**

Nominal voltage	24 V DC, 36 V DC, 72V DC, 110 V DC
Operating voltage range	0.70 ... 1.25 U <sub>N</sub>
Typ. pick-up voltage	≤ 0.7 U <sub>N</sub>
Typ. release voltage	≥ 0.1 U <sub>N</sub>
Pick-up time	15 ... 45 ms
Release time	20 ... 50 ms
Power consumption DC	2.6 W

**Insulation**

Rated insulation voltage	440 V
Rated impulse withstand voltage open contact	4 kV
Pollution degree	3
Overvoltage category	III
Clearance of open contact	3.6 mm

**General data**

Ambient temperature storage	-40 ... 80 °C
Ambient temperature operation	-40 ... 70 °C
Conductor cross section Control / Main Circuit	2.5 mm <sup>2</sup> / 6 mm <sup>2</sup>
Nominal screw torque Control / Main Circuit	0.6 Nm / 1.2 Nm
Module width	fig. 3
Weight	135 g
Protection degree	IP 20
Housing material	PA 6
Spacer	Integrated

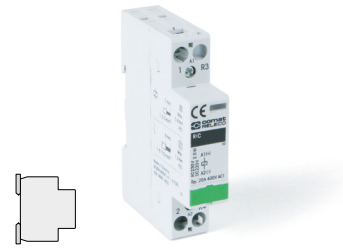
**Product references**

Main circuit	Product reference	24	36	72	110
2 NO	RIC20-200-R4A110V/DC...V	✓	✓	✓	✓
2 NC	RIC20-020-R4A110V/DC...V	✓	✓	✓	✓
1 NO + 1 NC	RIC20-110-R4A110V/DC...V	✓	✓	✓	✓

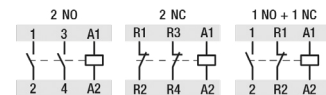
"..." list control circuit voltage to complete product references.  
Other voltages on request. Please contact support@comatreleco.com.

**Accessories**

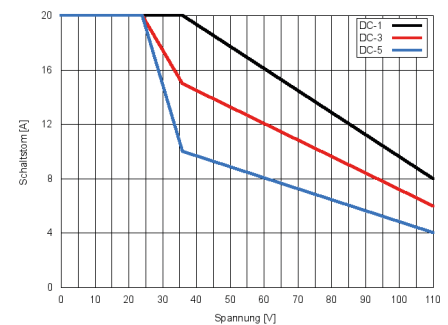
Sealing cover	RIC-SEAL20
---------------	------------



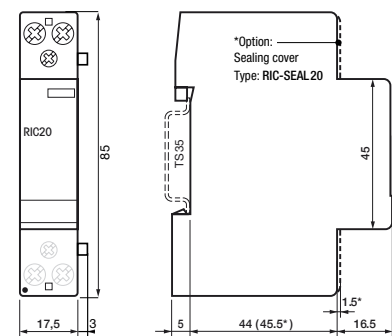
**fig. 1. Wiring diagram**



**fig. 2. DC load limit curve**



**fig. 3. Dimensions (mm)**



**Standards and approvals**

Standards IEC/EN 50155, IEC/EN 61373, IEC/EN 45545-2, IEC/EN 60947

Approvals **CE**



# RIC25

## Installation Contactor | 2 or 4 pole | 25 A | 5.4 kW

### Main circuit

Contact material	AgNi
Rated voltage	400 V
Rated current AC-1	25 A
Minimum contact load	50 mA, 17 V
Inrush current	60 A, 100 ms / 280 A, 300 μs
Rated load AC-1, 230 V	5.4 kW
Rated load AC-3, 230 V	1.3 kW
Rated load DC-1, DC-3, DC-5	fig. 2
Mechanical endurance (cycles)	≥ 1 × 10 <sup>7</sup>
Electrical endurance at rated load AC-1 (cycles)	≥ 2 × 10 <sup>5</sup>
Electrical endurance at rated load AC-3 (cycles)	≥ 5 × 10 <sup>7</sup>
Electrical endurance at rated load DC-1 (cycles)	≥ 1 × 10 <sup>5</sup>
Switching frequency at rated load AC-1 (cycles/h)	≤ 600
Switching frequency at rated load AC-3 (cycles/h)	≤ 600
Switching frequency at rated load DC-1 (cycles/h)	≤ 300

### Control circuit

Nominal voltage	48 V AC, 400 V AC	24 V UC, 36 V UC, 110 V UC, 230 V UC
Operating voltage range	0.85 ... 1.1 U <sub>N</sub>	
Typ. pick-up voltage	≤ 0.85 U <sub>N</sub>	
Typ. release voltage	≥ 0.1 U <sub>N</sub>	
Pick-up time	15 ... 45 ms	
Release time	20 ... 70 ms	
Power consumption AC / DC	2.6 VA / 2.6 W	
Rated frequency	50 / 60 Hz	40 ... 500Hz

### Insulation

Rated insulation voltage	440 V
Rated impulse withstand voltage open contact	4 kV
Pollution degree	3
Overvoltage category	III
Clearance of open contact	3.6 mm

### General data

Ambient temperature storage	-30 ... 80 °C
Ambient temperature operation 2 Device / 1 Spacer	-15 ... 55 °C
Ambient temperature operation 3 Device / 1 Spacer	-15 ... 40 °C
Conductor cross section Control / Main Circuit	2.5 mm <sup>2</sup> / 6 mm <sup>2</sup>
Nominal screw torque Control / Main Circuit	0.6 Nm / 1.2 Nm
Module width	fig. 3
Weight	250 g
Protection degree	IP 20
Housing material	PA 6

### Product references

Main circuit	Product reference	48	400	24	36	72	110	230
4 NO	RIC25-400/AC...V	✓	✓					
4 NC	RIC25-040/AC...V		✓					
4 NO	RIC25-400/UC...V			✓	✓			✓
4 NC	RIC25-040/UC...V			✓	✓	✓		✓
2 NO + 2 NC	RIC25-220/UC...V			✓	✓	✓	✓	✓
2 CO	RIC25-002/UC...V			✓				✓

"..." list control circuit voltage to complete product references.  
Other voltages on request. Please contact support@comatreleco.com.

### Accessories

Auxiliary module	RIC-AUX
Sealing cover	RIC-SEAL25
Spacer	RIC-DIST

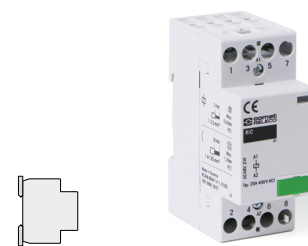


fig. 1. Wiring diagram

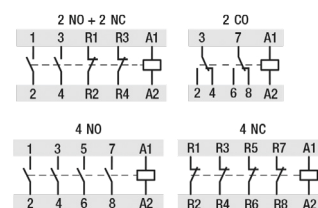


fig. 2. DC load limit curve

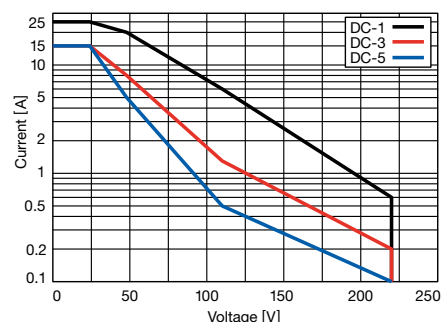
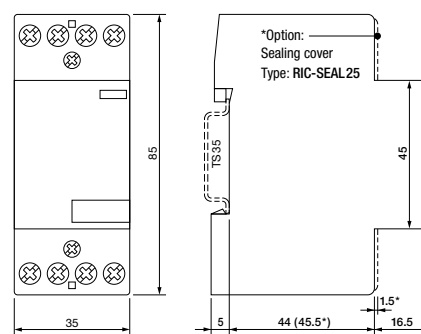


fig. 3. Dimensions (mm)



### Standards and approvals

Standards IEC/EN 60947, IEC/EN 61095

Approvals

**RIC32**

**Installation Contactor | 2 or 4 pole | 32 A | 7 kW**

**Main circuit**

Contact material	AgNi
Rated voltage	400 V
Rated current AC-1	32 A
Minimum contact load	50 mA, 17 V
Inrush current	60 A, 100 ms
Rated load AC-1, 230 V	7 kW
Rated load AC-3, 230 V	1.3 kW
Rated load DC-1, DC-3, DC-5	fig. 2
Mechanical endurance (cycles)	$\geq 1 \times 10^7$
Electrical endurance at rated load AC-1 (cycles)	$\geq 2 \times 10^5$
Electrical endurance at rated load AC-3 (cycles)	$\geq 5 \times 10^5$
Electrical endurance at rated load DC-1 (cycles)	$\geq 1 \times 10^5$
Switching frequency at rated load AC-1 (cycles/h)	$\leq 600$
Switching frequency at rated load AC-3 (cycles/h)	$\leq 600$
Switching frequency at rated load DC-1 (cycles/h)	$\leq 300$

**Control circuit**

Nominal voltage	230 V UC
Operating voltage range	0.85 ... 1.1 $U_N$
Typ. pick-up voltage	$\leq 0.85 U_N$
Typ. release voltage	$\geq 0.1 U_N$
Pick-up time	15 ... 45 ms
Release time	20 ... 70 ms
Power consumption AC / DC	2.6 VA / 2.6 W
Rated frequency	40 ... 500Hz

**Insulation**

Rated insulation voltage	440 V
Rated impulse withstand voltage open contact	4 kV
Pollution degree	3
Overvoltage category	III
Clearance of open contact	3.6 mm

**General data**

Ambient temperature storage	-30 ... 80 °C
Ambient temperature operation 2 Device / 1 Spacer	-15 ... 55 °C
Ambient temperature operation 3 Device / 1 Spacer	-15 ... 40 °C
Conductor cross section Control / Main Circuit	2.5 mm <sup>2</sup> / 6 mm <sup>2</sup>
Nominal screw torque Control / Main Circuit	0.6 Nm / 1.2 Nm
Module width	fig. 3
Weight	140 g (2 pole) / 250 g (4 pole)
Protection degree	IP 20
Housing material	PA 6

**Product references**

Main circuit	Product reference	230
2 NO	RIC32-200/UC...V	✓
2 NC	RIC32-020/UC...V	✓
1 NO + 1 NC	RIC32-110/UC...V	✓
4 NO	RIC32-400/UC...V	✓
4 NC	RIC32-040/UC...V	✓
2 NO + 2 NC	RIC32-220/UC...V	✓
3 NO + 1 NC	RIC32-310/UC...V	✓

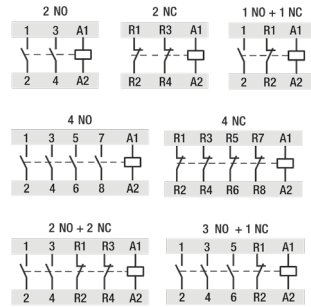
"..." list control circuit voltage to complete product references.  
Other voltages on request. Please contact support@comatreleco.com.

**Accessories**

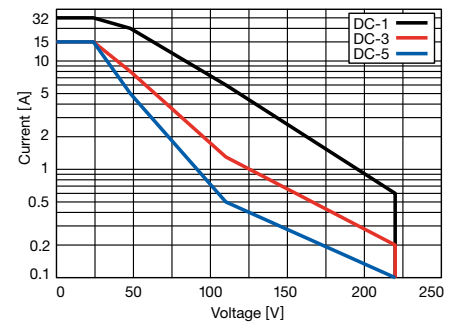
Auxiliary module	RIC-AUX
Sealing cover	RIC-SEAL20 / RIC-SEAL25
Spacer	RIC-DIST



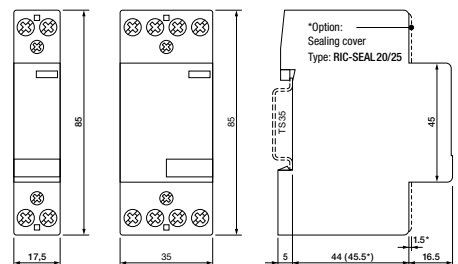
**fig. 1. Wiring diagram**



**fig. 2. DC load limit curve**



**fig. 3. Dimensions (mm)**



**Standards and approvals**

Standards IEC/EN 60947, IEC/EN 61095

Approvals

1.7 Installation Contactors

**RIC40**

**Installation Contactor | 4 pole | 40 A | 8.7 kW**

**Main circuit**

Contact material	⚡ AgSnO <sub>2</sub>
Rated voltage	400 V
Rated current AC-1	40 A
Minimum contact load	50 mA, 17 V
Inrush current	170 A, 100 ms / 970 A, 300 μs
Rated load AC-1, 230 V	8.7 kW
Rated load AC-3, 230 V	3.7 kW
Rated load DC-1, DC-3, DC-5	fig. 2
Mechanical endurance (cycles)	≥ 1 x 10 <sup>7</sup>
Electrical endurance at rated load AC-1 (cycles)	≥ 1 x 10 <sup>5</sup>
Electrical endurance at rated load AC-3 (cycles)	≥ 1.5 x 10 <sup>5</sup>
Electrical endurance at rated load DC-1 (cycles)	≥ 1 x 10 <sup>5</sup>
Switching frequency at rated load AC-1 (cycles/h)	≤ 600
Switching frequency at rated load AC-3 (cycles/h)	≤ 600
Switching frequency at rated load DC-1 (cycles/h)	≤ 300

**Control circuit**

Nominal voltage	230 V AC	24 V UC, 48 V UC, 230 V UC
Operating voltage range	0.85 ... 1.1 U <sub>N</sub>	
Typ. pick-up voltage	≤ 0.85 U <sub>N</sub>	
Typ. release voltage	≥ 0.1 U <sub>N</sub>	
Pick-up time	15 ... 20 ms	
Release time	35 ... 45 ms	
Power consumption AC / DC	5 VA / 5 W	
Rated frequency	50 / 60 Hz	40 ... 500 Hz

**Insulation**

Rated insulation voltage	440 V
Rated impulse withstand voltage open contact	6 kV
Pollution degree	3
Overtoltage category	III
Clearance of open contact	3.6 mm

**General data**

Ambient temperature storage	-30 ... 80 °C
Ambient temperature operation 2 Device / 1 Spacer	-15 ... 55 °C
Ambient temperature operation 3 Device / 1 Spacer	-15 ... 40 °C
Conductor cross section Control / Main Circuit	2.5 mm <sup>2</sup> / 16 mm <sup>2</sup>
Nominal screw torque Control / Main Circuit	0.6 Nm / 3.5 Nm
Module width	fig. 3
Weight	420 g
Protection degree	IP 20
Housing material	PA 6

**Product references**

Main circuit	Product reference	230	24	48
4 NC	RIC40-040/AC...V	✓		
4 NO	RIC40-400/UC...V	✓	✓	
4 NC	RIC40-040/UC...V	✓	✓	
4 NC	RIC40-040/UC...V	✓	✓	✓
2 NO + 2 NC	RIC40-220/UC...V	✓	✓	✓

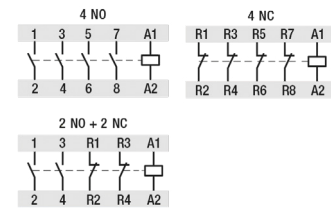
"..." list control circuit voltage to complete product references.  
Other voltages on request. Please contact support@comatreleco.com.

**Accessories**

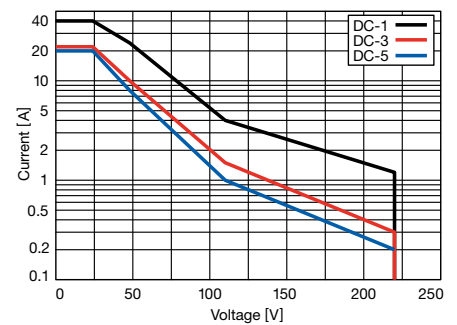
Auxiliary module	RIC-AUX
Sealing cover	RIC-SEAL40/63
Spacer	RIC-DIST



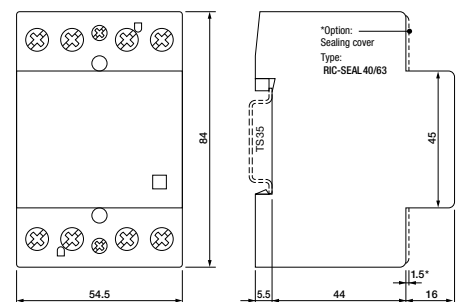
**fig. 1. Wiring diagram**



**fig. 2. DC load limit curve**



**fig. 3. Dimensions (mm)**



**Standards and approvals**

Standards IEC/EN 60947, IEC/EN 61095

Approvals **CE EAC**

### RIC63

#### Installation Contactor | 4 pole | 63 A | 13.3 kW

##### Main circuit

Contact material	AgSnO <sub>2</sub>
Rated voltage	400 V
Rated current AC-1	63A
Minimum contact load	50 mA, 17 V
Inrush current	240 A, 100 ms / 1500 A, 300 μs
Rated load AC-1, 230 V	13.3 kW
Rated load AC-3, 230 V	6 kW
Rated load DC-1, DC-3, DC-5	fig. 2
Mechanical endurance (cycles)	≥ 1 x 10 <sup>7</sup>
Electrical endurance at rated load AC-1 (cycles)	≥ 1 x 10 <sup>5</sup>
Electrical endurance at rated load AC-3 (cycles)	≥ 1.5 x 10 <sup>5</sup>
Electrical endurance at rated load DC-1 (cycles)	≥ 1 x 10 <sup>5</sup>
Switching frequency at rated load AC-1 (cycles/h)	≤ 600
Switching frequency at rated load AC-3 (cycles/h)	≤ 600
Switching frequency at rated load DC-1 (cycles/h)	≤ 300

##### Control circuit

Nominal voltage	230 V AC	24 V UC, 230 V UC
Operating voltage range	0.85 ... 1.1 U <sub>N</sub>	
Typ. pick-up voltage	≤ 0.85 U <sub>N</sub>	
Typ. release voltage	≥ 0.1 U <sub>N</sub>	
Pick-up time	15 ... 20 ms	
Release time	35 ... 45 ms	
Power consumption AC / DC	5 VA / 5 W	
Rated frequency	50 / 60 Hz	40 ... 500 Hz

##### Insulation

Rated insulation voltage	440 V
Rated impulse withstand voltage open contact	6 kV
Pollution degree	3
Overvoltage category	III
Clearance of open contact	3.6 mm

##### General data

Ambient temperature storage	-30 ... 80 °C
Ambient temperature operation 2 Device / 1 Spacer	-15 ... 55 °C
Ambient temperature operation 3 Device / 1 Spacer	-15 ... 40 °C
Conductor cross section Control / Main Circuit	2.5 mm <sup>2</sup> / 16 mm <sup>2</sup>
Nominal screw torque Control / Main Circuit	0.6 Nm / 3.5 Nm
Module width	fig. 3
Weight	420 g
Protection degree	IP 20
Housing material	PA 6

##### Product references

Main circuit	Product reference	230	24
4 NC	RIC63-040/AC...V	✓	
4 NO	RIC63-400/UC...V	✓	✓
4 NC	RIC63-040/UC...V		✓
2 NO + 2 NC	RIC63-220/UC...V	✓	✓

"..." list control circuit voltage to complete product references.  
Other voltages on request. Please contact support@comatreleco.com.

##### Accessories

Auxiliary module	RIC-AUX
Sealing cover	RIC-SEAL40/63
Spacer	RIC-DIST



fig. 1. Wiring diagram

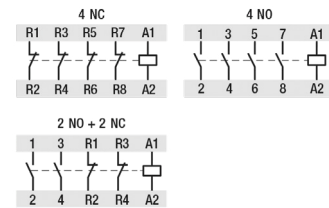


fig. 2. DC load limit curve

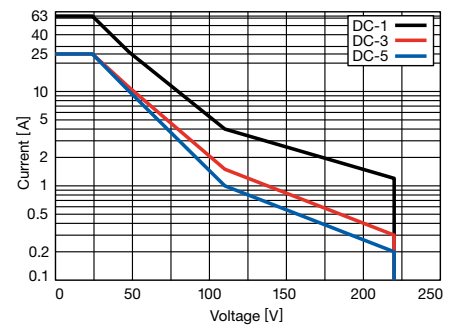
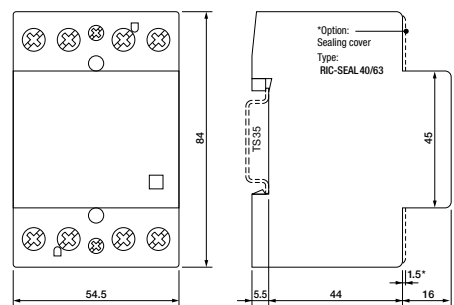


fig. 3. Dimensions (mm)



##### Standards and approvals

Standards IEC/EN 60947, IEC/EN 61095

Approvals

# RAC20

## Installation Contactor – manual lever Auto - 1 - Lock | 2 pole | 20 A | 4 kW

### Main circuit

Contact material	⚡ AgNi
Rated voltage	400 V
Rated current AC-1	20 A
Minimum contact load	50 mA, 17 V
Inrush current	50 A, 100 ms / 180 A, 300 μs
Rated load AC-1, 230 V	4 kW
Rated load AC-3, 230 V	1.3 kW (NO) / 0.75 kW (NC)
Rated load DC-1, DC-3, DC-5	fig. 2
Mechanical endurance (cycles)	≥ 1 × 10 <sup>7</sup>
Electrical endurance at rated load AC-1 (cycles)	≥ 2 × 10 <sup>5</sup>
Electrical endurance at rated load AC-3 (cycles)	≥ 3 × 10 <sup>5</sup>
Electrical endurance at rated load DC-1 (cycles)	≥ 1 × 10 <sup>5</sup>
Switching frequency at rated load AC-1 (cycles/h)	≤ 600
Switching frequency at rated load AC-3 (cycles/h)	≤ 600
Switching frequency at rated load DC-1 (cycles/h)	≤ 300

### Control circuit

Nominal voltage	24 V UC, 230 V UC
Operating voltage range	0.85 ... 1.1 U <sub>N</sub>
Typ. pick-up voltage	≤ 0.85 U <sub>N</sub>
Typ. release voltage	≥ 0.1 U <sub>N</sub>
Pick-up time	15 ... 45 ms
Release time	20 ... 50 ms
Power consumption AC / DC	2.1 VA / 2.1 W
Rated frequency	40 ... 500Hz

### Insulation

Rated insulation voltage	440 V
Rated impulse withstand voltage open contact	4 kV
Pollution degree	3
Overvoltage category	III
Clearance of open contact	3.6 mm

### General data

Ambient temperature storage	-30 ... 80 °C
Ambient temperature operation 2 Device / 1 Spacer	-15 ... 55 °C
Ambient temperature operation 3 Device / 1 Spacer	-15 ... 40 °C
Conductor cross section Control / Main Circuit	2.5 mm <sup>2</sup> / 6 mm <sup>2</sup>
Nominal screw torque Control / Main Circuit	0.6 Nm / 1.2 Nm
Module width	fig. 3
Weight	130 g
Protection degree	IP 20
Housing material	PA 6

### Product references

Main circuit	Product reference	24	230
2 NO	RAC20-200/UC...V	✓	✓
2 NC	RAC20-020/UC...V	✓	✓
1 NO + 1 NC	RAC20-110/UC...V	✓	✓

"..." list control circuit voltage to complete product references.  
Other voltages on request. Please contact support@comatreleco.com.

### Accessories

Sealing cover	RIC-SEAL20
Spacer	RIC-DIST

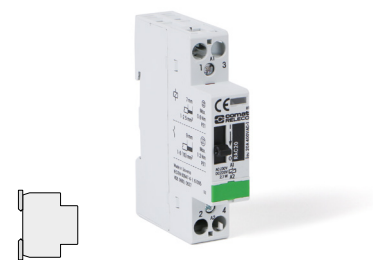


fig. 1. Wiring diagram

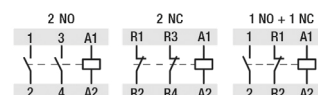


fig. 2. DC load limit curve

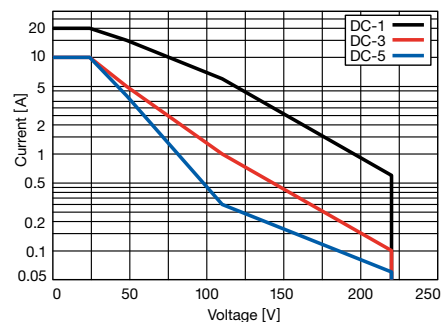
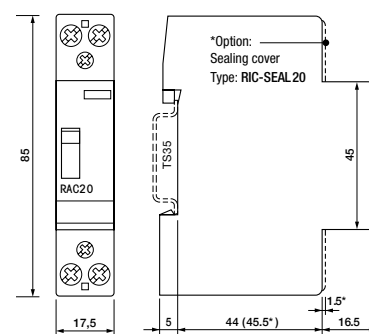


fig. 3. Dimensions (mm)



### Standards and approvals

Standards IEC/EN 60947, IEC/EN 61095

Approvals



## RAC25

### Installation Contactor – manual lever Auto - 1 - Lock | 2 pole | 25 A | 5.4 kW

#### Main circuit

Contact material	AgNi
Rated voltage	400 V
Rated current AC-1	25 A
Minimum contact load	50 mA, 17 V
Inrush current	60 A, 100 ms / 280 A, 300 μs
Rated load AC-1, 230 V	5.4 kW
Rated load AC-3, 230 V	1.3 kW
Rated load DC-1, DC-3, DC-5	fig. 2
Mechanical endurance (cycles)	$\geq 1 \times 10^7$
Electrical endurance at rated load AC-1 (cycles)	$\geq 2 \times 10^5$
Electrical endurance at rated load AC-3 (cycles)	$\geq 5 \times 10^5$
Electrical endurance at rated load DC-1 (cycles)	$\geq 1 \times 10^5$
Switching frequency at rated load AC-1 (cycles/h)	$\leq 600$
Switching frequency at rated load AC-3 (cycles/h)	$\leq 600$
Switching frequency at rated load DC-1 (cycles/h)	$\leq 300$

#### Control circuit

Nominal voltage	24 V UC, 230 V UC
Operating voltage range	0.85 ... 1.1 $U_N$
Typ. pick-up voltage	$\leq 0.85 U_N$
Typ. release voltage	$\geq 0.1 U_N$
Pick-up time	15 ... 45 ms
Release time	20 ... 70 ms
Power consumption AC / DC	2.6 VA / 2.6 W
Rated frequency	40 ... 500Hz

#### Insulation

Rated insulation voltage	440 V
Rated impulse withstand voltage open contact	4 kV
Pollution degree	3
Overvoltage category	III
Clearance of open contact	3.6 mm

#### General data

Ambient temperature storage	-30 ... 80 °C
Ambient temperature operation 2 Device / 1 Spacer	-15 ... 55 °C
Ambient temperature operation 3 Device / 1 Spacer	-15 ... 40 °C
Conductor cross section Control / Main Circuit	2.5 mm <sup>2</sup> / 6 mm <sup>2</sup>
Nominal screw torque Control / Main Circuit	0.6 Nm / 1.2 Nm
Module width	fig. 3
Weight	250 g
Protection degree	IP 20
Housing material	PA 6

#### Product references

Main circuit	Product reference	24	230
4 NO	RAC25-400/UC...V	✓	✓
2 NO + 2 NC	RAC25-220/UC...V	✓	✓

"..." list control circuit voltage to complete product references.  
Other voltages on request. Please contact support@comatreleco.com.

#### Accessories

Auxiliary module	RIC-AUX
Sealing cover	RIC-SEAL25
Spacer	RIC-DIST

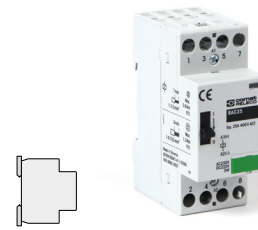


fig. 1. Wiring diagram

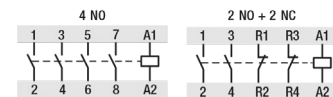


fig. 2. DC load limit curve

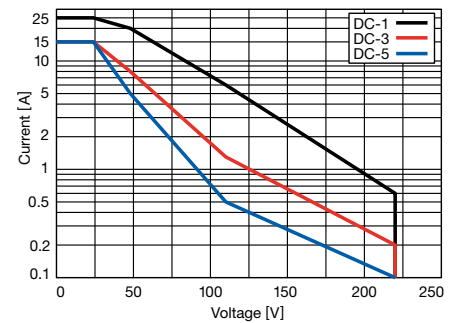
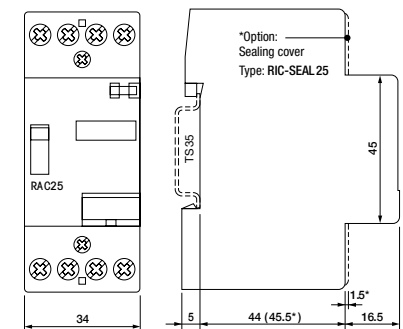


fig. 3. Dimensions (mm)



#### Standards and approvals

Standards IEC/EN 60947, IEC/EN 61095

Approvals

## RAC40

### Installation Contactor – manual lever Auto - 1 - Lock | 4 pole | 40 A | 8.7 kW

#### Main circuit

Contact material	AgSnO <sub>2</sub>
Rated voltage	400 V
Rated current AC-1	40 A
Minimum contact load	50 mA, 17 V
Inrush current	170 A, 100 ms / 970 A, 300 μs
Rated load AC-1, 230 V	8.7 kW
Rated load AC-3, 230 V	3.7 kW
Rated load DC-1, DC-3, DC-5	fig. 2
Mechanical endurance (cycles)	≥ 1 × 10 <sup>7</sup>
Electrical endurance at rated load AC-1 (cycles)	≥ 1 × 10 <sup>5</sup>
Electrical endurance at rated load AC-3 (cycles)	≥ 1.5 × 10 <sup>5</sup>
Electrical endurance at rated load DC-1 (cycles)	≥ 1 × 10 <sup>5</sup>
Switching frequency at rated load AC-1 (cycles/h)	≤ 600
Switching frequency at rated load AC-3 (cycles/h)	≤ 600
Switching frequency at rated load DC-1 (cycles/h)	≤ 300

#### Control circuit

Nominal voltage	230 V AC
Operating voltage range	0.85 ... 1.1 U <sub>N</sub>
Typ. pick-up voltage	≤ 0.85 U <sub>N</sub>
Typ. release voltage	≥ 0.1 U <sub>N</sub>
Pick-up time	15 ... 20 ms
Release time	35 ... 45 ms
Power consumption AC / DC	5 VA / 5 W
Rated frequency	50 / 60 Hz

#### Insulation

Rated insulation voltage	440 V
Rated impulse withstand voltage open contact	6 kV
Pollution degree	3
Overvoltage category	III
Clearance of open contact	3.6 mm

#### General data

Ambient temperature storage	-30 ... 80 °C
Ambient temperature operation 2 Device / 1 Spacer	-15 ... 55 °C
Ambient temperature operation 3 Device / 1 Spacer	-15 ... 40 °C
Conductor cross section Control / Main Circuit	2.5 mm <sup>2</sup> / 16 mm <sup>2</sup>
Nominal screw torque Control / Main Circuit	0.6 Nm / 3.5 Nm
Module width	fig. 3
Weight	420 g
Protection degree	IP 20
Housing material	PA 6

#### Product references

Main circuit	Product reference	230
4 NO	RAC40-400/AC...V	✓
3 NO + 1 NC	RAC40-310/AC...V	✓

"..." list control circuit voltage to complete product references.

Other voltages on request. Please contact support@comatreleco.com.

#### Accessories

Auxiliary module	RIC-AUX
Sealing cover	RIC-SEAL40/63
Spacer	RIC-DIST



fig. 1. Wiring diagram

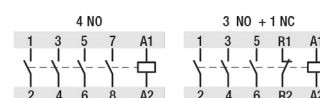


fig. 2. DC load limit curve

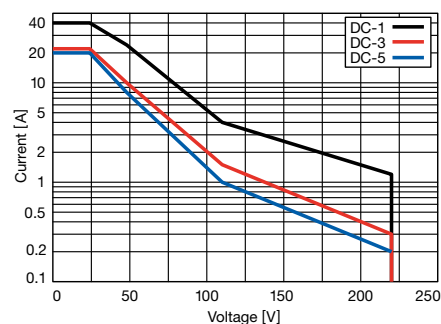
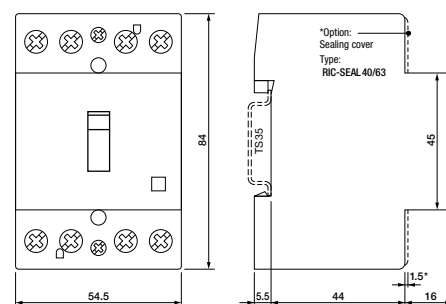


fig. 3. Dimensions (mm)



#### Standards and approvals

Standards IEC/EN 60947, IEC/EN 61095

Approvals



## RAC63

### Installation Contactor – manual lever Auto - 1 - Lock | 4 pole | 63 A | 13.3 kW

#### Main circuit

Contact material	AgSnO <sub>2</sub>
Rated voltage	400 V
Rated current AC-1	63 A
Minimum contact load	50 mA, 17 V
Inrush current	240 A, 100 ms / 1500 A, 300 μs
Rated load AC-1, 230 V	13.3 kW
Rated load AC-3, 230 V	6 kW
Rated load DC-1, DC-3, DC-5	fig. 2
Mechanical endurance (cycles)	≥ 1 x 10 <sup>7</sup>
Electrical endurance at rated load AC-1 (cycles)	≥ 1 x 10 <sup>5</sup>
Electrical endurance at rated load AC-3 (cycles)	≥ 1.5 x 10 <sup>5</sup>
Electrical endurance at rated load DC-1 (cycles)	≥ 1 x 10 <sup>5</sup>
Switching frequency at rated load AC-1 (cycles/h)	≤ 600
Switching frequency at rated load AC-3 (cycles/h)	≤ 600
Switching frequency at rated load DC-1 (cycles/h)	≤ 300

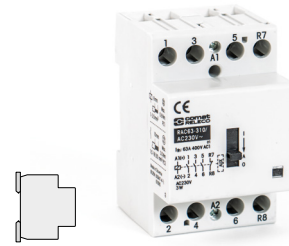
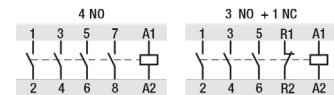


fig. 1. Wiring diagram



#### Control circuit

Nominal voltage	230 V AC
Operating voltage range	0.85 ... 1.1 U <sub>N</sub>
Typ. pick-up voltage	≤ 0.85 U <sub>N</sub>
Typ. release voltage	≥ 0.1 U <sub>N</sub>
Pick-up time	15 ... 20 ms
Release time	35 ... 45 ms
Power consumption AC / DC	5 VA / 5 W
Rated frequency	50 / 60 Hz

#### Insulation

Rated insulation voltage	440 V
Rated impulse withstand voltage open contact	6 kV
Pollution degree	3
Overvoltage category	III
Clearance of open contact	3.6 mm

#### General data

Ambient temperature storage	-30 ... 80 °C
Ambient temperature operation 2 Device / 1 Spacer	-15 ... 55 °C
Ambient temperature operation 3 Device / 1 Spacer	-15 ... 40 °C
Conductor cross section Control / Main Circuit	2.5 mm <sup>2</sup> / 16 mm <sup>2</sup>
Nominal screw torque Control / Main Circuit	0.6 Nm / 3.5 Nm
Module width	fig. 3
Weight	420 g
Protection degree	IP 20
Housing material	PA 6

#### Product references

Main circuit	Product reference	230
4 NO	RAC63-400/AC...V	✓
3 NO + 1 NC	RAC63-310/AC...V	✓

"..." list control circuit voltage to complete product references.  
Other voltages on request. Please contact support@comatreleco.com.

#### Accessories

Auxiliary module	RIC-AUX
Sealing cover	RIC-SEAL40/63
Spacer	RIC-DIST

fig. 2. DC load limit curve

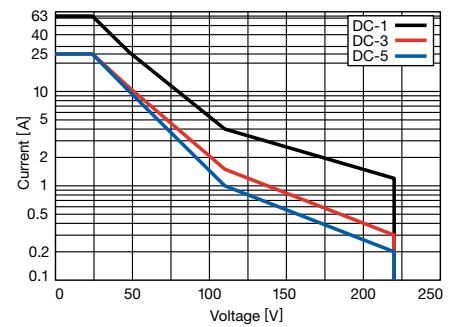
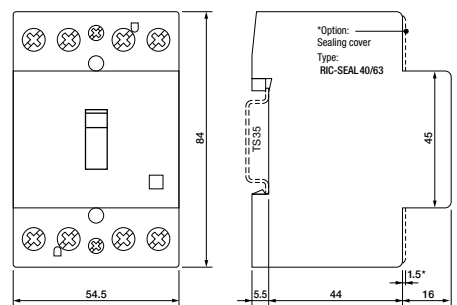


fig. 3. Dimensions (mm)



#### Standards and approvals

Standards IEC/EN 60947, IEC/EN 61095

Approvals



## RBC20

### Installation Contactor – Step switch - manual lever 0 - 1 - Lock | 2 or 4 pole | 20 A | 4.4 kW

#### Main circuit

Contact material	AgNi
Rated voltage	400 V
Rated current AC-1	20 A
Minimum contact load	100 mA, 10 V
Inrush current	50 A, 100 ms / 180 A, 300 μs
Rated load AC-1, 230 V	4.4 kW
Rated load AC-3, 230 V	0.55 kW
Rated load DC-1, DC-3, DC-5	fig. 2
Mechanical endurance (cycles)	≥ 1 x 10 <sup>6</sup>
Electrical endurance at rated load AC-1 (cycles)	≥ 1 x 10 <sup>5</sup>
Electrical endurance at rated load AC-3 (cycles)	≥ 1 x 10 <sup>5</sup>
Electrical endurance at rated load DC-1 (cycles)	≥ 1 x 10 <sup>5</sup>
Switching frequency at rated load AC-1 (cycles/h)	≤ 600
Switching frequency at rated load AC-3 (cycles/h)	≤ 600
Switching frequency at rated load DC-1 (cycles/h)	≤ 300

#### Control circuit

Nominal voltage	24 V AC, 230 V AC
Operating voltage range	0.9 ... 1.1 U <sub>N</sub>
Typ. pick-up voltage	≤ 0.75 U <sub>N</sub>
Typ. release voltage	≥ 0.1 U <sub>N</sub>
Minimal impulse duration at rated voltage U <sub>N</sub>	50 ms
Minimal impulse duration at 0.9 U <sub>N</sub>	100 ms
Minimal pause between two impulses	150 ms
Maximal number of impulses	≤ 15 / min
Maximal impulse duration	≤ 60 / min
Pick-up time	5 ... 35 ms
Release time	5 ... 35 ms
Power consumption AC / DC	9 VA / - W
Rated frequency	50 / 60 Hz

#### Insulation

Rated insulation voltage	440 V
Rated impulse withstand voltage open contact	4 kV
Pollution degree	3
Overvoltage category	III
Clearance of open contact	> 3 mm

#### General data

Ambient temperature storage	-30 ... 80 °C
Ambient temperature operation 2 Device / 1 Spacer	55 ° ... 70 °C
Ambient temperature operation 3 Device / 1 Spacer	40 ° ... 55 °C
Conductor cross section Control / Main Circuit	4 mm <sup>2</sup> / 10 mm <sup>2</sup>
Nominal screw torque Control / Main Circuit	0.6 Nm / 1.2 Nm
Module width	fig. 3
Weight	132 g (2 pole) / 250 g (4 pole)
Protection degree	IP 20
Housing material	PA 6

#### Product references

Main circuit	Product reference	24	230
2 NO	RBC20-200/AC...V	✓	✓
1 NO + 1 NC	RBC20-110/AC...V	✓	
4 NO	RBC20-400/AC...V	✓	✓

“...” list control circuit voltage to complete product references.  
Other voltages on request. Please contact support@comatreleco.com.

#### Accessories

Auxiliary module	RBC-AUX
Auxiliary module for centralised control	RBC-AUX-CM
Auxiliary module for group control	RBC-AUX-GM
Spacer	RIC-DIST

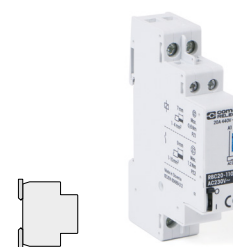


fig. 1. Wiring diagram

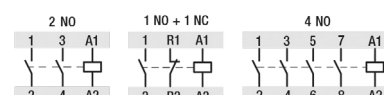


fig. 2. DC load limit curve

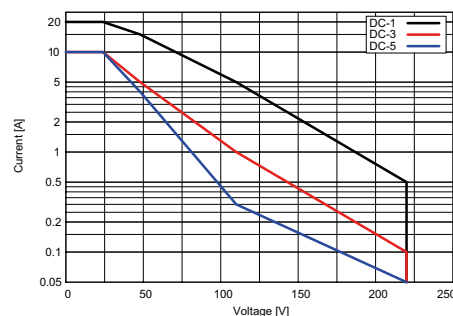
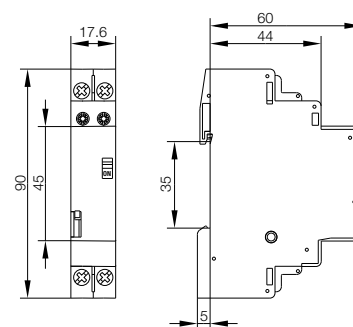


fig. 3. Dimensions (mm)



#### Standards and approvals

Standards IEC/EN 60947, IEC/EN 61095

Approvals CE EAC

## RBC32

### Installation Contactor – Step switch - manual lever 0 - 1 - Lock | 4 pole | 32 A | 7 kW

#### Main circuit

Contact material	AgNi
Rated voltage	440 V
Rated current AC-1	32 A
Minimum contact load	100 mA, 10 V
Inrush current	50 A, 100 ms / 180 A, 300 μs
Rated load AC-1, 230 V	7 kW
Rated load AC-3, 230 V	1.1 kW
Rated load DC-1, DC-3, DC-5	fig. 2
Mechanical endurance (cycles)	≥ 1 x 10 <sup>6</sup>
Electrical endurance at rated load AC-1 (cycles)	≥ 1 x 10 <sup>5</sup>
Electrical endurance at rated load AC-3 (cycles)	≥ 1 x 10 <sup>5</sup>
Electrical endurance at rated load DC-1 (cycles)	≥ 1 x 10 <sup>5</sup>
Switching frequency at rated load AC-1 (cycles/h)	≤ 450
Switching frequency at rated load AC-3 (cycles/h)	≤ 450
Switching frequency at rated load DC-1 (cycles/h)	≤ 300

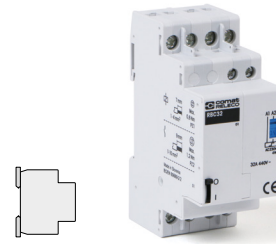
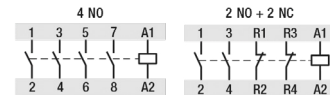


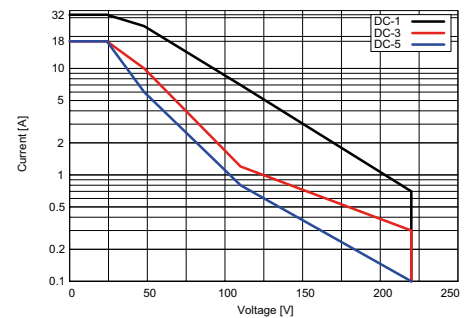
fig. 1. Wiring diagram



#### Control circuit

Nominal voltage	230 V AC
Operating voltage range	0.9 ... 1.1 U <sub>N</sub>
Typ. pick-up voltage	≤ 0.75 U <sub>N</sub>
Typ. release voltage	≥ 0.1 U <sub>N</sub>
Minimal impulse duration at rated voltage U <sub>N</sub>	50 ms
Minimal impulse duration at 0.9 U <sub>N</sub>	100 ms
Minimal pause between two impulses	150 ms
Maximal number of impulses	≤ 8 / min
Maximal impulse duration	≤ 60 / min
Pick-up time	5 ... 35 ms
Release time	5 ... 35 ms
Power consumption AC / DC	9 VA / - W
Rated frequency	50 / 60 Hz

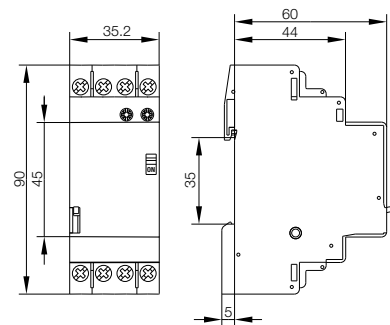
fig. 2. DC load limit curve



#### Insulation

Rated insulation voltage	440 V
Rated impulse withstand voltage open contact	4 kV
Pollution degree	3
Overvoltage category	III
Clearance of open contact	> 3 mm

fig. 3. Dimensions (mm)



#### General data

Ambient temperature storage	-30 ... 80 °C
Ambient temperature operation 2 Device / 1 Spacer	55 ° ... 70 °C
Ambient temperature operation 3 Device / 1 Spacer	40 ° ... 55 °C
Conductor cross section Control / Main Circuit	4 mm <sup>2</sup> / 10 mm <sup>2</sup>
Nominal screw torque Control / Main Circuit	0.6 Nm / 1.2 Nm
Module width	fig. 3
Weight	192 g
Protection degree	IP 20
Housing material	PA 6

#### Standards and approvals

Standards IEC/EN 60947, IEC/EN 61095

Approvals

#### Product references

Main circuit	Product reference	230
4 NO	RBC32-400/AC...V	✓
2 NO + 2 NC	RBC32-220/AC...V	✓

"..." list control circuit voltage to complete product references.

Other voltages on request. Please contact support@comatreleco.com.

#### Accessories

Auxiliary module	RBC-AUX
Auxiliary module for centralised control	RBC-AUX-CM
Auxiliary module for group control	RBC-AUX-GM
Spacer	RIC-DIST

## RIC-AUX

Auxiliary module for RIC | RAC Installation contactors | 2 pole | 6 A

### Main circuit

Contact material	AgNi
Rated voltage	230 V / 400 V
Rated current AC-1	6 A / 4 A
Minimum contact load	5 mA, 12 V

### Insulation

Rated insulation voltage	500 V
Rated impulse withstand voltage	4 kV
Pollution degree	3
Overvoltage category	III
Clearance of open contact	3.6 mm

### General data

Ambient temperature storage	-30 ... 80 °C
Ambient temperature operation	-25 ... 55 °C
Conductor cross section main circuit	2.5 mm <sup>2</sup>
Nominal screw torque Control / Main Circuit	- Nm / 0.8 Nm
Module width	fig. 2
Weight	30 g
Protection degree	IP 20
Housing material	PA 6

### Product references

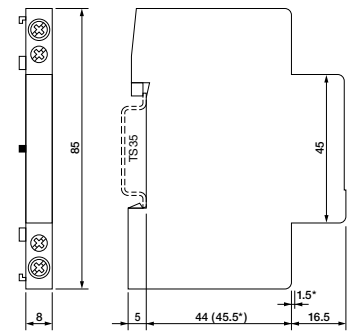
Main circuit	Product reference
2 NO	RIC-AUX20
2 NC	RIC-AUX02
1 NO + 1 NC	RIC-AUX11



fig. 1. Wiring diagram



fig. 2. Dimensions (mm)



### Standards and approvals

Standards IEC/EN 60947

Approvals

## RBC-AUX

Auxiliary module for step switch Installation contactors | 2 pole | 6 A

### Main circuit

Contact material	AgNi
Rated voltage	250 V
Rated current AC-1	6 A
Minimum contact load	5 mA, 12 V

### Insulation

Rated insulation voltage	440 V
Rated impulse withstand voltage open contact	4 kV
Rated impulse withstand voltage	4 kV
Pollution degree	3
Overvoltage category	III
Clearance of open contact	> 3 mm

### General data

Ambient temperature storage	-30 ... 80 °C
Ambient temperature operation open contact	-25 ... 70 °C
Conductor cross section main circuit	2.5 mm <sup>2</sup>
Nominal screw torque Control / Main Circuit	- Nm / 0.8 Nm
Module width	fig. 2
Weight	30 g
Protection degree	IP 20
Housing material	PA 6

### Product references

Main circuit	Product reference
2 NO	RBC-AUX20
1 NO + 1 NC	RBC-AUX11

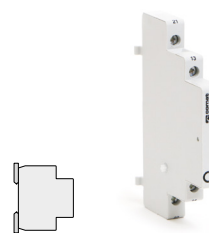


fig. 1. Wiring diagram

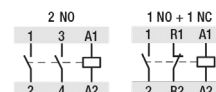
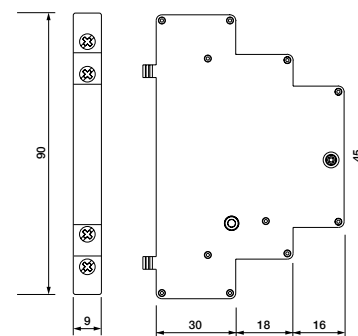


fig. 2. Dimensions (mm)



### Standards and approvals

Standards IEC/EN 60947

Approvals

## RBC-AUX-CM

### Auxiliary module for step switch Installation contactors - centralized control ON - OFF

#### Main circuit

Rated voltage 250 V

#### Insulation

Rated insulation voltage 440 V

Pollution degree 3

#### General data

Ambient temperature storage -30 ... 80 °C

Ambient temperature operation open contact -25 ... 70 °C

Conductor cross section main circuit 2.5 mm<sup>2</sup>

Nominal screw torque Control / Main Circuit - Nm / 0.8 Nm

Module width fig. 2

Weight 30 g

Protection degree IP 20

Housing material PA 6

#### Product references

Description	Product reference
Centralized control ON – OFF	RBC-AUX-CM

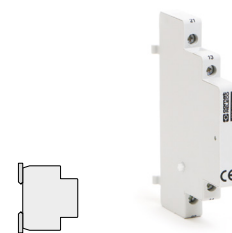


fig. 1. Wiring diagram

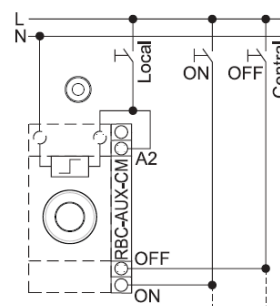
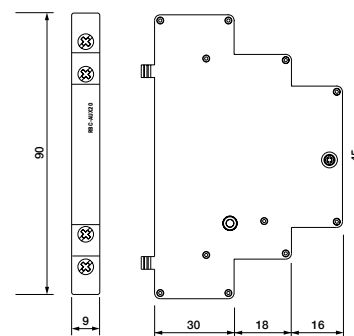


fig. 2. Dimensions (mm)



#### Standards and approvals

Standards IEC/EN 60947

Approvals

## RBC-AUX-GM

Auxiliary module for step switch Installation contactors - group control ON - OFF

### Main circuit

Rated voltage 250 V

### Insulation

Rated insulation voltage 440 V

Pollution degree 3

### General data

Ambient temperature storage -30 ... 80 °C

Ambient temperature operation open contact -25 ... 70 °C

Conductor cross section main circuit 2.5 mm<sup>2</sup>

Nominal screw torque Control / Main Circuit - Nm / 0.8 Nm

Module width fig. 2

Weight 30 g

Protection degree IP 20

Housing material PA 6

### Product references

Description	Product reference
Group control ON – OFF	RBC-AUX-GM

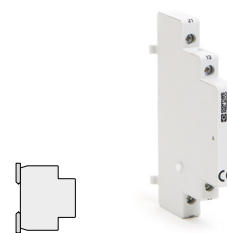


fig. 1. Wiring diagram

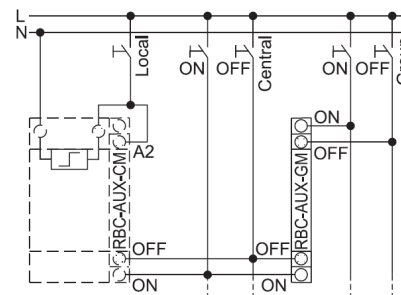
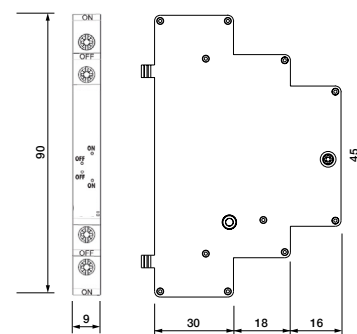


fig. 2. Dimensions (mm)



### Standards and approvals

Standards IEC/EN 60947

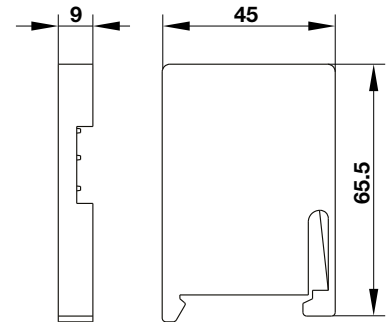
Approvals

**RIC-DIST****Auxiliary spacer module for RIC / RAC installation contactors****General data**

Ambient temperature storage	-30 ... 80 °C
Module width	fig. 1
Weight	13 g
Material	PA 6

**Product references**

Description	Product reference
Spacer	RIC-DIST

**fig. 1. Dimensions (mm)**

**RIC-SEAL****Auxiliary sealing cover for RIC / RAC installation contactors****General data**

Ambient temperature storage	-30 ... 80 °C
Weight RIC-SEAL20, RIC-SEAL25, RIC-SEAL 40/63	1 g, 2 g, 3 g
Material	PA 6

**Product references**

Description	Product reference
Sealing cover	RIC-SEAL20
Sealing cover	RIC-SEAL25
Sealing cover	RIC-SEAL40/63



## 1.8 Industrial Contactors

Application	Type	Page
<b>RMC Series</b>		
Industrial Contactor   4 pole   8.5 A   4 kW	RMC08	114
Industrial Contactor   4 pole   11.3 A   5.5 kW	RMC11	115
<b>RSC Series</b>		
Industrial Contactor   3 or 4 pole   9 A   4 kW	RSC09	116
Industrial Contactor   3 or 4 pole   12 A   5.5 kW	RSC12	117
Industrial Contactor   3 or 4 pole   16 A   7.5 kW	RSC16	118
Industrial Contactor   3 pole   22 A   11 kW	RSC22	119
Industrial Contactor   3 pole   30 A   15 kW	RSC30	120
Industrial Contactor   3 pole   38 A   18.5 kW	RSC38	121
Industrial Contactor   5 pole   43 A   22 kW	RSC43	122
Industrial Contactor   5 pole   63 A   30 kW	RSC63	123
Bimetallic thermal relay   5 pole   01 ... 10 A	RSC-MP	124
<b>Accessories</b>		
Auxiliary module   2 or 4 pole   6 A	RMC-AUX	125
Auxiliary module   2 or 4 pole   6 A	RSC-AUX	126
Supressor	RMC-RC	127
Supressor	RSC-RC	128
Supressor	RMC-DI	129
Mechanical interlock	RSC-MBL	130

# RMC08

Industrial Contactor | 4 pole | 8.5 A | 4 kW

### Main circuit

Contact material	AgNi
Rated voltage	690 V
Rated current AC-1	20 A
Rated current AC-3	8.5 A, 400 V
Rated current DC-13	0.25 A, 110 VDC
Minimum contact load	50 mA, 17 V
Rated load AC-1, 400 V	13 kW
Rated load AC-3, 400 V	4 kW
Mechanical endurance (cycles)	$\geq 1 \times 10^7$
Electrical endurance at rated load AC-1 (cycles)	$\geq 2 \times 10^5$
Electrical endurance at rated load AC-3 (cycles)	fig. 2
Switching frequency at rated load AC-1 (cycles/h)	$\leq 600$
Switching frequency at rated load AC-3 (cycles/h)	$\leq 600$
Switching frequency at rated load DC-3	$\leq 300$

### Control circuit

Nominal voltage	24 V AC, 230 V AC	24 V DC
Operating voltage range	0.85 ... 1.1 U <sub>N</sub>	
Typ. pick-up voltage	$\leq 0.85 U_N$	
Typ. release voltage	$\geq 0.2 U_N$ AC	$\geq 0.1 U_N$ DC
Pick-up time	10 ... 15 ms	
Release time	6 ... 15 ms	
Power consumption AC / DC	8.1 VA / 4 W	
Rated frequency	50 / 60 Hz	

### Insulation

Rated insulation voltage	690 V
Rated impulse withstand voltage	6 kV
Pollution degree	3
Overvoltage category	III
Clearance of open contact	3.6 mm

### General data

Ambient temperature storage	-30 ... 80 °C
Ambient temperature operation open contact	-20 ... 60 °C
Ambient temperature operation close contact	-20 ... 45 °C
Conductor cross section Control / Main Circuit	2.5 mm <sup>2</sup> / 2.5 mm <sup>2</sup>
Nominal screw torque Control / Main Circuit	1.2 Nm / 1.2 Nm
Module width	fig. 3
Weight AC / DC Device	160 g / 215 g
Protection degree	IP 20
Housing material	PA 66

### Product references

Main circuit	Product reference	24	230
3 NO + 1 NO	RMC08-310/AC...V	✓	✓
3 NO + 1 NC	RMC08-301/AC...V	✓	✓
3 NO + 1 NO	RMC08-310/DC...V	✓	
3 NO + 1 NC	RMC08-301/DC...V	✓	

"..." list control circuit voltage to complete product references  
Other voltages on request. Please contact support@comatreleco.com

### Accessories

Auxiliary module	RMC-AUX
RC - Suppressor	RMC-RC
DI - Suppressor	RMC-DI



fig. 1. Wiring diagram

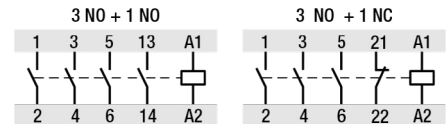


fig. 2. Electrical endurance

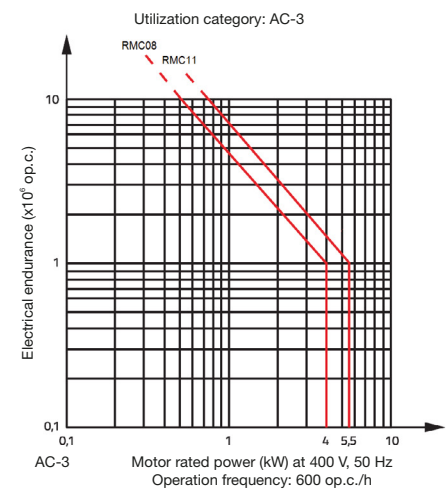
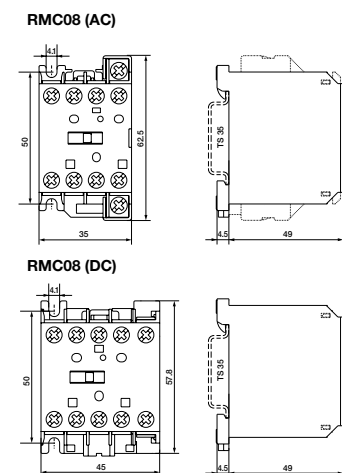


fig. 3. Dimensions (mm)



### Standards and approvals

Standards IEC/EN 60947

Approvals

# RMC11

Industrial Contactor | 4 pole | 11.3 A | 5.5 kW

### Main circuit

Contact material	AgNi
Rated voltage	690 V
Rated current AC-1	20 A
Rated current AC-3	11.3 A, 400 V
Rated current DC-13	0.25 A, 110 VDC
Minimum contact load	50 mA, 17 V
Rated load AC-1, 400 V	13 kW
Rated load AC-3, 400 V	5.5 kW
Mechanical endurance (cycles)	$\geq 1 \times 10^7$
Electrical endurance at rated load AC-1 (cycles)	$\geq 2 \times 10^5$
Electrical endurance at rated load AC-3 (cycles)	fig. 2
Switching frequency at rated load AC-1 (cycles/h)	$\leq 600$
Switching frequency at rated load AC-3 (cycles/h)	$\leq 600$
Switching frequency at rated load DC-3	$\leq 300$

### Control circuit

Nominal voltage	24 V AC, 230 V AC	24 V DC
Operating voltage range	0.85 ... 1.1 $U_N$	
Typ. pick-up voltage	$\leq 0.85 U_N$	
Typ. release voltage	$\geq 0.2 U_N$ AC	$\geq 0.1 U_N$ DC
Pick-up time	10 ... 15 ms	
Release time	6 ... 15 ms	
Power consumption AC / DC	8.1 VA / 4 W	
Rated frequency	50 / 60 Hz	

### Insulation

Rated insulation voltage	690 V
Rated impulse withstand voltage	6 kV
Pollution degree	3
Overvoltage category	III
Clearance of open contact	3.6 mm

### General data

Ambient temperature storage	-30 ... 80 °C
Ambient temperature operation open contact	-20 ... 60 °C
Ambient temperature operation close contact	-20 ... 45 °C
Conductor cross section Control / Main Circuit	2.5 mm <sup>2</sup> / 2.5 mm <sup>2</sup>
Nominal screw torque Control / Main Circuit	1.2 Nm / 1.2 Nm
Module width	fig. 3
Weight AC / DC Device	170 g / 215 g
Protection degree	IP 20
Housing material	PA 66

### Product references

Main circuit	Product reference	24	230
3 NO + 1 NO	RMC11-310/AC...V	✓	✓
3 NO + 1 NC	RMC11-301/AC...V	✓	✓
3 NO + 1 NO	RMC11-310/DC...V	✓	
3 NO + 1 NC	RMC11-301/DC...V	✓	

"..." list control circuit voltage to complete product references  
Other voltages on request. Please contact support@comatreleco.com

### Accessories

Auxiliary module	RMC-AUX
RC - Suppressor	RMC-RC
DI - Suppressor	RMC-DI

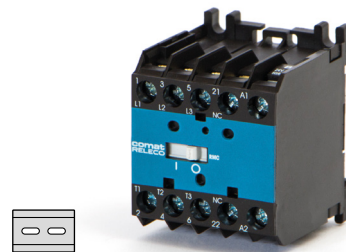


fig. 1. Wiring diagram

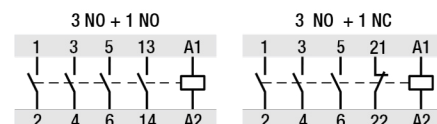


fig. 2. Electrical endurance

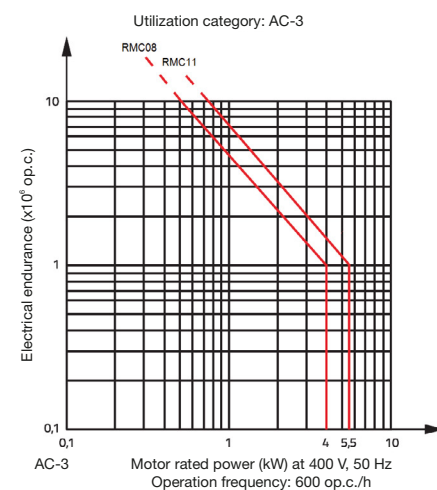
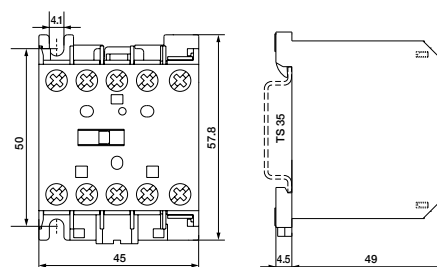


fig. 3. Dimensions (mm)



### Standards and approvals

Standards IEC/EN 60947

Approvals

**RSC09**

**Industrial Contactor | 3 or 4 pole | 9 A | 4 kW**



**Main circuit**

Contact material	AgNi
Rated voltage	690 V
Rated current AC-1	25 A
Rated current AC-3	9 A, 400 V
Rated current DC-3	0.75 A, 220 V DC
Minimum contact load	50 mA, 17 V
Overload current	72 A (10 s) / 220 A (0.001 s)
Rated load AC-1, 400 V	16 kW
Rated load AC-3, 400 V	4 kW
Mechanical endurance (cycles)	$\geq 1 \times 10^7$
Electrical endurance at rated load AC-1 (cycles)	$\geq 2 \times 10^5$
Electrical endurance at rated load AC-3 (cycles)	fig. 2
Switching frequency at rated load AC-1 (cycles/h)	$\leq 600$
Switching frequency at rated load AC-3 (cycles/h)	$\leq 600$
Switching frequency at rated load DC-3	$\leq 300$

**Control circuit**

Nominal voltage	24 V AC, 230 V AC	24 V DC
Operating voltage range	0.85 ... 1.1 $U_N$	
Typ. pick-up voltage	$\leq 0.85 U_N$	
Typ. release voltage	$\geq 0.2 U_N$ AC	$\geq 0.1 U_N$ DC
Pick-up time	10 ... 25 ms	
Release time	5 ... 15 ms	
Power consumption AC / DC	8.0 VA / 2.5 W	
Rated frequency	50 / 60 Hz	

**Insulation**

Rated insulation voltage	690 V
Rated impulse withstand voltage	6 kV
Pollution degree	3
Overvoltage category	III
Clearance of open contact	3.6 mm

**General data**

Ambient temperature storage	-30 ... 80 °C
Ambient temperature operation open contact	-25 ... 55 °C
Ambient temperature operation close contact	-25 ... 45 °C
Conductor cross section Control / Main Circuit	4 mm <sup>2</sup> / 6 mm <sup>2</sup>
Nominal screw torque Control / Main Circuit	1.4 Nm / 1.4 Nm
Module width	fig. 3
Weight	300 g
Protection degree	IP 20
Housing material	PA 66

**Product references**

Main circuit	Product reference	24	230
3 NO + 1 NO	RSC09-310/AC...V	✓	✓
3 NO + 1 NC	RSC09-301/AC...V	✓	✓
3 NO	RSC09-300/DC...V	✓	

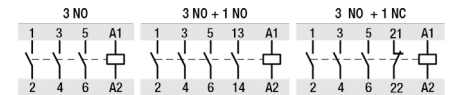
"..." list control circuit voltage to complete product references  
Other voltages on request. Please contact support@comatreleco.com

**Accessories**

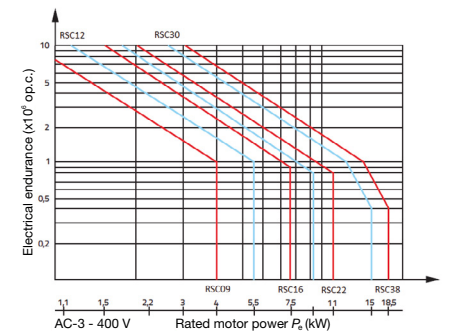
Auxiliary module	RSC-AUX
Bimetallic thermal relay	RSC-MP
RC - Suppressor	RSC-RC
DI - Suppressor	RMC-DI
MBL - Mechanical locking	RSC-MBL1



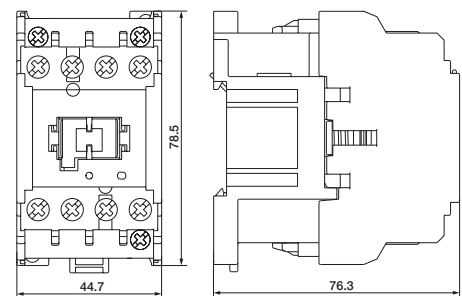
**fig. 1. Wiring diagram**



**fig. 2. Electrical endurance**



**fig. 3. Dimensions (mm)**



**Standards and approvals**

Standards IEC/EN 60947



**RSC12**

**Industrial Contactor | 3 or 4 pole | 12 A | 5.5 kW**

**Main circuit**

Contact material	AgNi
Rated voltage	690 V
Rated current AC-1	25 A
Rated current AC-3	12 A, 400 V
Rated current DC-3	0.75 A, 220 V DC
Minimum contact load	50 mA, 17 V
Overload current	96 A (10 s) / 330 A (0.001 s)
Rated load AC-1, 400 V	16 kW
Rated load AC-3, 400 V	5.5 kW
Mechanical endurance (cycles)	$\geq 1 \times 10^7$
Electrical endurance at rated load AC-1 (cycles)	$\geq 2 \times 10^5$
Electrical endurance at rated load AC-3 (cycles)	fig. 2
Switching frequency at rated load AC-1 (cycles/h)	$\leq 600$
Switching frequency at rated load AC-3 (cycles/h)	$\leq 600$
Switching frequency at rated load DC-3	$\leq 300$

**Control circuit**

Nominal voltage	24 V AC, 230 V AC	24 V DC
Operating voltage range	0.85 ... 1.1 $U_N$	
Typ. pick-up voltage	$\leq 0.85 U_N$	
Typ. release voltage	$\geq 0.2 U_N$ AC	$\geq 0.1 U_N$ DC
Pick-up time	10 ... 25 ms	
Release time	5 ... 15 ms	
Power consumption AC / DC	8.0 VA / 2.5 W	
Rated frequency	50 / 60 Hz	

**Insulation**

Rated insulation voltage	690 V
Rated impulse withstand voltage	6 kV
Pollution degree	3
Overvoltage category	III
Clearance of open contact	3.6 mm

**General data**

Ambient temperature storage	-30 ... 80 °C
Ambient temperature operation open contact	-25 ... 55 °C
Ambient temperature operation close contact	-25 ... 45 °C
Conductor cross section Control / Main Circuit	4 mm <sup>2</sup> / 6 mm <sup>2</sup>
Nominal screw torque Control / Main Circuit	1.4 Nm / 1.4 Nm
Module width	fig. 3
Weight	300 g
Protection degree	IP 20
Housing material	PA 66

**Product references**

Main circuit	Product reference	24	230
3 NO + 1 NO	RSC12-310/AC...V	✓	✓
3 NO + 1 NC	RSC12-301/AC...V	✓	✓
3 NO	RSC12-300/DC...V	✓	

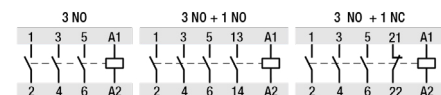
"..." list control circuit voltage to complete product references  
Other voltages on request. Please contact support@comatreleco.com

**Accessories**

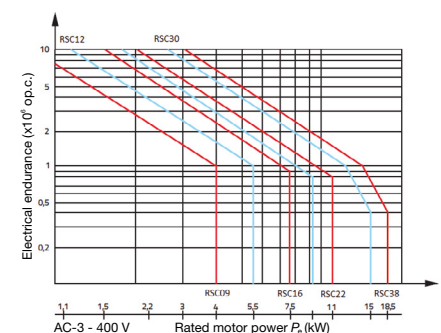
Auxiliary module	RSC-AUX
Bimetallic thermal relay	RSC-MP
RC - Suppressor	RSC-RC
DI - Suppressor	RMC-DI
MBL - Mechanical locking	RSC-MBL1



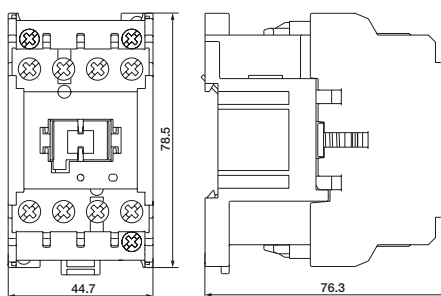
**fig. 1. Wiring diagram**



**fig. 2. Electrical endurance**



**fig. 3. Dimensions (mm)**



**Standards and approvals**

Standards IEC/EN 60947

Approvals

**RSC16**

**Industrial Contactor | 3 or 4 pole | 16 A | 7.5 kW**



**Main circuit**

Contact material	AgNi
Rated voltage	690 V
Rated current AC-1	25 A
Rated current AC-3	16 A, 400 V
Rated current DC-3	0.75 A, 220 V DC
Minimum contact load	50 mA, 17 V
Overload current	128 A (10 s) / 450 A (0.001 s)
Rated load AC-1, 400 V	16 kW
Rated load AC-3, 400 V	7.5 kW
Mechanical endurance (cycles)	≥ 1 x 10 <sup>7</sup>
Electrical endurance at rated load AC-1 (cycles)	≥ 2 x 10 <sup>5</sup>
Electrical endurance at rated load AC-3 (cycles)	fig. 2
Switching frequency at rated load AC-1 (cycles/h)	≤ 600
Switching frequency at rated load AC-3 (cycles/h)	≤ 600
Switching frequency at rated load DC-3	≤ 300

**Control circuit**

Nominal voltage	24 V AC, 230 V AC	24 V DC
Operating voltage range	0.85 ... 1.1 U <sub>N</sub>	
Typ. pick-up voltage	≤ 0.85 U <sub>N</sub>	
Typ. release voltage	≥ 0.2 U <sub>N</sub> AC	≥ 0.1 U <sub>N</sub> DC
Pick-up time	10 ... 25 ms	
Release time	5 ... 15 ms	
Power consumption AC / DC	8.0 VA / 2.5 W	
Rated frequency	50 / 60 Hz	

**Insulation**

Rated insulation voltage	690 V
Rated impulse withstand voltage	6 kV
Pollution degree	3
Overvoltage category	III
Clearance of open contact	3.6 mm

**General data**

Ambient temperature storage	-30 ... 80 °C
Ambient temperature operation open contact	-25 ... 55 °C
Ambient temperature operation close contact	-25 ... 45 °C
Conductor cross section Control / Main Circuit	4 mm <sup>2</sup> / 6 mm <sup>2</sup>
Nominal screw torque Control / Main Circuit	1.4 Nm / 1.4 Nm
Module width	fig. 3
Weight	300 g
Protection degree	IP 20
Housing material	PA 66

**Product references**

Main circuit	Product reference	24	230
3 NO + 1 NO	RSC16-310/AC...V	✓	✓
3 NO + 1 NC	RSC16-301/AC...V	✓	✓
3 NO	RSC16-300/DC...V	✓	

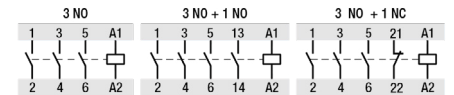
"..." list control circuit voltage to complete product references  
Other voltages on request. Please contact support@comatreleco.com

**Accessories**

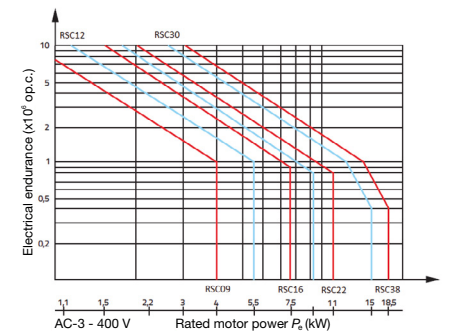
Auxiliary module	RSC-AUX
Bimetallic thermal relay	RSC-MP
RC - Suppressor	RSC-RC
DI - Suppressor	RMC-DI
MBL - Mechanical locking	RSC-MBL1



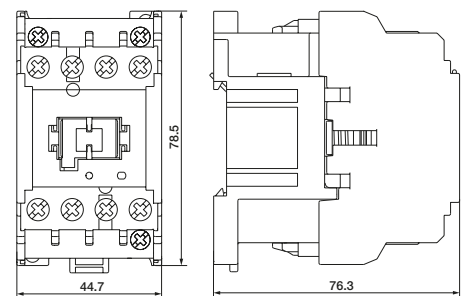
**fig. 1. Wiring diagram**



**fig. 2. Electrical endurance**



**fig. 3. Dimensions (mm)**



**Standards and approvals**

Standards IEC/EN 60947

Approvals

**RSC22**

**Industrial Contactor | 3 pole | 22 A | 11 kW**

**Main circuit**

Contact material	⚡ AgNiO <sub>2</sub>
Rated voltage	1000 V
Rated current AC-1	35 A
Rated current AC-3	22 A, 400 V
Rated current DC-3	1 A, 220 V DC
Minimum contact load	50 mA, 17 V
Overload current	176 A (10 s) / 600 A (0.001 s)
Rated load AC-1, 400 V	23 kW
Rated load AC-3, 400 V	11 kW
Mechanical endurance (cycles)	≥ 1 x 10 <sup>7</sup>
Electrical endurance at rated load AC-1 (cycles)	≥ 2 x 10 <sup>5</sup>
Electrical endurance at rated load AC-3 (cycles)	fig. 2
Switching frequency at rated load AC-1 (cycles/h)	≤ 600
Switching frequency at rated load AC-3 (cycles/h)	≤ 600
Switching frequency at rated load DC-3	≤ 300

**Control circuit**

Nominal voltage	24 V AC, 230 V AC	24 V DC
Operating voltage range	0.85 ... 1.1 U <sub>N</sub>	
Typ. pick-up voltage	≤ 0.85 U <sub>N</sub>	
Typ. release voltage	≥ 0.2 U <sub>N</sub> AC	≥ 0.1 U <sub>N</sub> DC
Pick-up time	10 ... 20 ms	
Release time	5 ... 15 ms	
Power consumption AC / DC	8.0 VA / 2.5 W	
Rated frequency	50 / 60 Hz	

**Insulation**

Rated insulation voltage	1000 V
Rated impulse withstand voltage	6 kV
Pollution degree	3
Overvoltage category	III
Clearance of open contact	3.6 mm

**General data**

Ambient temperature storage	-30 ... 80 °C
Ambient temperature operation open contact	-25 ... 55 °C
Ambient temperature operation close contact	-25 ... 45 °C
Conductor cross section Control / Main Circuit	4 mm <sup>2</sup> / 10 mm <sup>2</sup>
Nominal screw torque Control / Main Circuit	1.4 Nm / 1.8 Nm
Module width	fig. 3
Weight	320 g
Protection degree	IP 20
Housing material	PA 66

**Product references**

Main circuit	Product reference	24	230
3 NO	RSC22-300/AC...V	✓	✓
3 NO	RSC22-300/DC...V	✓	

"..." list control circuit voltage to complete product references  
 Other voltages on request. Please contact support@comatreleco.com

**Accessories**

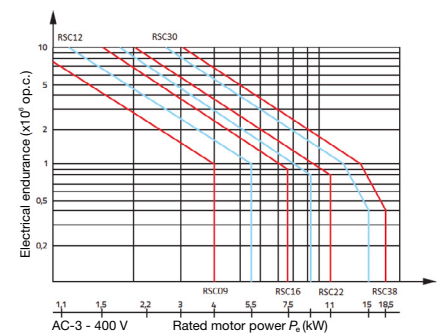
Auxiliary module	RSC-AUX
RC - Suppressor	RSC-RC
DI - Suppressor	RMC-DI
MBL - Mechanical locking	RSC-MBL1



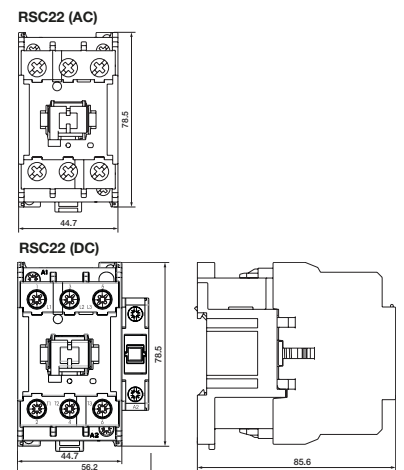
**fig. 1. Wiring diagram**



**fig. 2. Electrical endurance**



**fig. 3. Dimensions (mm)**



**Standards and approvals**

Standards IEC/EN 60947

Approvals

# RSC30

Industrial Contactor | 3 pole | 30 A | 15 kW

### Main circuit

Contact material	AgNiO <sub>2</sub>
Rated voltage	1000 V
Rated current AC-1	35 A
Rated current AC-3	30 A, 400 V
Rated current DC-3	1 A, 220 V DC
Minimum contact load	50 mA, 17 V
Overload current	240 A (10 s) / 900 A (0.001 s)
Rated load AC-1, 400 V	23 kW
Rated load AC-3, 400 V	15 kW
Mechanical endurance (cycles)	≥ 1 x 10 <sup>7</sup>
Electrical endurance at rated load AC-1 (cycles)	≥ 2 x 10 <sup>5</sup>
Electrical endurance at rated load AC-3 (cycles)	fig. 2
Switching frequency at rated load AC-1 (cycles/h)	≤ 600
Switching frequency at rated load AC-3 (cycles/h)	≤ 600
Switching frequency at rated load DC-3	≤ 300

### Control circuit

Nominal voltage	24 V AC, 230 V AC	24 V DC
Operating voltage range	0.85 ... 1.1 U <sub>N</sub>	
Typ. pick-up voltage	≤ 0.85 U <sub>N</sub>	
Typ. release voltage	≥ 0.2 U <sub>N</sub> AC	≥ 0.1 U <sub>N</sub> DC
Pick-up time	10 ... 20 ms	
Release time	5 ... 15 ms	
Power consumption AC / DC	8.0 VA / 2.5 W	
Rated frequency	50 / 60 Hz	

### Insulation

Rated insulation voltage	1000 V
Rated impulse withstand voltage	6 kV
Pollution degree	3
Overvoltage category	III
Clearance of open contact	3.6 mm

### General data

Ambient temperature storage	-30 ... 80 °C
Ambient temperature operation open contact	-25 ... 55 °C
Ambient temperature operation close contact	-25 ... 45 °C
Conductor cross section Control / Main Circuit	4 mm <sup>2</sup> / 10 mm <sup>2</sup>
Nominal screw torque Control / Main Circuit	1.4 Nm / 1.8 Nm
Module width	fig. 3
Weight	320 g
Protection degree	IP 20
Housing material	PA 66

### Product references

Main circuit	Product reference	24	230
3 NO	RSC30-300/AC...V	✓	✓
3 NO	RSC30-300/DC...V	✓	

"..." list control circuit voltage to complete product references  
 Other voltages on request. Please contact support@comatreleco.com

### Accessories

Auxiliary module	RSC-AUX
RC - Suppressor	RSC-RC
DI - Suppressor	RMC-DI
MBL - Mechanical locking	RSC-MBL1



fig. 1. Wiring diagram

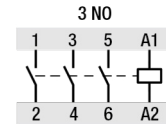


fig. 2. Electrical endurance

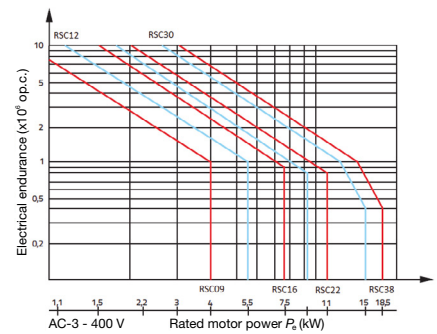
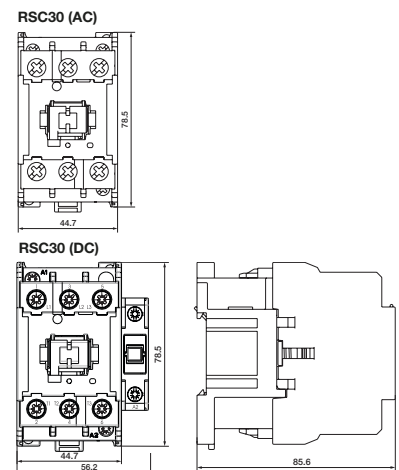


fig. 3. Dimensions (mm)



### Standards and approvals

Standards IEC/EN 60947

Approvals



**RSC38**

**Industrial Contactor | 3 pole | 38 A | 18.5 kW**

**Main circuit**

Contact material	⚡ AgNiO <sub>2</sub>
Rated voltage	1000 V
Rated current AC-1	45 A
Rated current AC-3	38 A, 400 V
Rated current DC-3	1 A, 220 V DC
Minimum contact load	50 mA, 17 V
Overload current	304 A (10 s) / 900 A (0.001 s)
Rated load AC-1, 400 V	29 kW
Rated load AC-3, 400 V	18.5 kW
Mechanical endurance (cycles)	≥ 1 x 10 <sup>7</sup>
Electrical endurance at rated load AC-1 (cycles)	≥ 2 x 10 <sup>5</sup>
Electrical endurance at rated load AC-3 (cycles)	fig. 2
Switching frequency at rated load AC-1 (cycles/h)	≤ 600
Switching frequency at rated load AC-3 (cycles/h)	≤ 600
Switching frequency at rated load DC-3	≤ 300

**Control circuit**

Nominal voltage	24 V AC, 230 V AC	24 V DC
Operating voltage range	0.85 ... 1.1 U <sub>N</sub>	
Typ. pick-up voltage	≤ 0.85 U <sub>N</sub>	
Typ. release voltage	≥ 0.2 U <sub>N</sub> AC	≥ 0.1 U <sub>N</sub> DC
Pick-up time	10 ... 20 ms	
Release time	5 ... 15 ms	
Power consumption AC / DC	10 VA / 2.5 W	
Rated frequency	50 / 60 Hz	

**Insulation**

Rated insulation voltage	1000 V
Rated impulse withstand voltage	6 kV
Pollution degree	3
Overvoltage category	III
Clearance of open contact	3.6 mm

**General data**

Ambient temperature storage	-30 ... 80 °C
Ambient temperature operation open contact	-25 ... 55 °C
Ambient temperature operation close contact	-25 ... 45 °C
Conductor cross section Control / Main Circuit	4 mm <sup>2</sup> / 10 mm <sup>2</sup>
Nominal screw torque Control / Main Circuit	1.4 Nm / 1.8 Nm
Module width	fig. 3
Weight	320 g
Protection degree	IP 20
Housing material	PA 66

**Product references**

Main circuit	Product reference	24	230
3 NO	RSC38-300/AC...V	✓	✓
3 NO	RSC38-300/DC...V	✓	

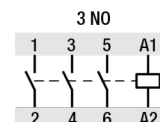
"..." list control circuit voltage to complete product references  
 Other voltages on request. Please contact support@comatreleco.com

**Accessories**

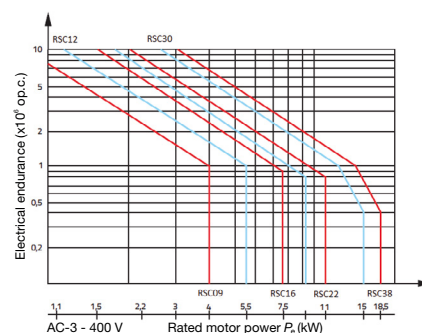
Auxiliary module	RSC-AUX
RC - Suppressor	RSC-RC
DI - Suppressor	RMC-DI
MBL - Mechanical locking	RSC-MBL1



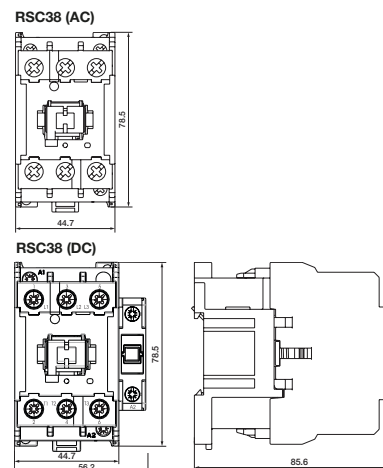
**fig. 1. Wiring diagram**



**fig. 2. Electrical endurance**



**fig. 3. Dimensions (mm)**



**Standards and approvals**

Standards IEC/EN 60947

Approvals

**RSC43**

**Industrial Contactor | 5 pole | 43 A | 22 kW**

**Main circuit**

Contact material	⚡ AgNiO <sub>2</sub>
Rated voltage	1000 V
Rated current AC-1	75 A
Rated current AC-3	43 A, 400 V
Rated current DC-1	6 A, 220 V DC
Minimum contact load	50 mA, 17 V
Overload current	344 A (10 s)
Rated load AC-1, 400 V	56 kW
Rated load AC-3, 400 V	22 kW
Mechanical endurance (cycles)	≥ 3 x 10 <sup>6</sup>
Electrical endurance at rated load AC-1 (cycles)	≥ 2 x 10 <sup>5</sup>
Electrical endurance at rated load AC-3 (cycles)	fig. 2
Switching frequency at rated load AC-1 (cycles/h)	≤ 600
Switching frequency at rated load AC-3 (cycles/h)	≤ 600
Switching frequency at rated load DC-3	≤ 300

**Control circuit**

Nominal voltage	24 V AC, 230 V AC
Operating voltage range	0.85 ... 1.1 U <sub>N</sub>
Typ. pick-up voltage	≤ 0.85 U <sub>N</sub>
Typ. release voltage	≥ 0.2 U <sub>N</sub> AC
Pick-up time	10 ... 20 ms
Release time	8 ... 15 ms
Power consumption AC	10 VA
Rated frequency	50 / 60 Hz

**Insulation**

Rated insulation voltage	1000 V
Rated impulse withstand voltage	6 kV
Pollution degree	3
Overvoltage category	III
Clearance of open contact	3.6 mm

**General data**

Ambient temperature storage	-30 ... 80 °C
Ambient temperature operation open contact	-20 ... 60 °C
Ambient temperature operation close contact	-20 ... 45 °C
Conductor cross section Control / Main Circuit	2.5 mm <sup>2</sup> / 35 mm <sup>2</sup>
Nominal screw torque Control / Main Circuit	0.8 Nm / 4 Nm
Module width	fig. 3
Weight	930 g
Protection degree	IP 20
Housing material	PA 66

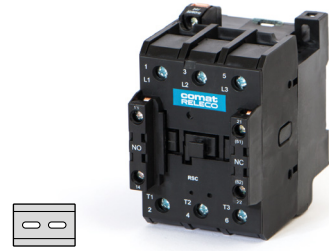
**Product references**

Main circuit	Product reference	24	230
3 NO + 1 NO + 1 NC	RSC43-310/AC...V	✓	✓

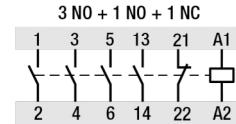
"..." list control circuit voltage to complete product references  
 Other voltages on request. Please contact support@comatreleco.com

**Accessories**

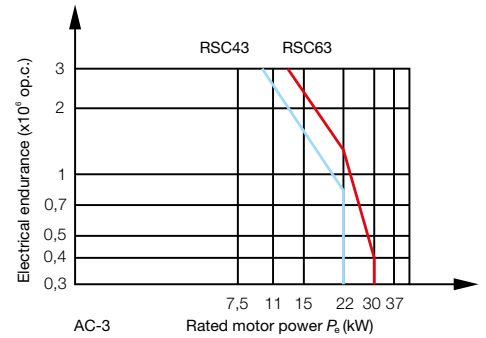
Auxiliary module	RSC-AUX
RC - Suppressor	RSC-RC
DI - Suppressor	RMC-DI
MBL - Mechanical locking	RSC-MBL2



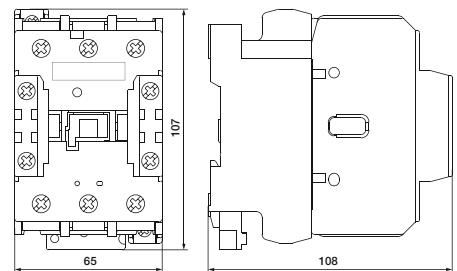
**fig. 1. Wiring diagram**



**fig. 2. Electrical endurance**



**fig. 3. Dimensions (mm)**



**Standards and approvals**

Standards IEC/EN 60947

Approvals

**RSC63****Industrial Contactor | 5 pole | 63 A | 30 kW****Main circuit**

Contact material	AgNiO <sub>2</sub>
Rated voltage	1000 V
Rated current AC-1	85 A
Rated current AC-3	63 A, 400 V
Rated current DC-1	6 A, 220 V DC
Minimum contact load	50 mA, 17 V
Overload current	504 A (10 s)
Rated load AC-1, 400 V	66 kW
Rated load AC-3, 400 V	30 kW
Mechanical endurance (cycles)	≥ 3 × 10 <sup>6</sup>
Electrical endurance at rated load AC-1 (cycles)	≥ 2 × 10 <sup>5</sup>
Electrical endurance at rated load AC-3 (cycles)	fig. 2
Switching frequency at rated load AC-1 (cycles/h)	≤ 600
Switching frequency at rated load AC-3 (cycles/h)	≤ 600
Switching frequency at rated load DC-3	≤ 300

**Control circuit**

Nominal voltage	24 V AC, 230 V AC
Operating voltage range	0.85 ... 1.1 U <sub>N</sub>
Typ. pick-up voltage	≤ 0.85 U <sub>N</sub>
Typ. release voltage	≥ 0.2 U <sub>N</sub> AC
Pick-up time	10 ... 20 ms
Release time	8 ... 15 ms
Power consumption AC	10 VA
Rated frequency	50 / 60 Hz

**Insulation**

Rated insulation voltage	1000 V
Rated impulse withstand voltage	6 kV
Pollution degree	3
Overvoltage category	III
Clearance of open contact	3.6 mm

**General data**

Ambient temperature storage	-30 ... 80 °C
Ambient temperature operation open contact	-20 ... 60 °C
Ambient temperature operation close contact	-20 ... 45 °C
Conductor cross section Control / Main Circuit	2.5 mm <sup>2</sup> / 35 mm <sup>2</sup>
Nominal screw torque Control / Main Circuit	0.8 Nm / 4 Nm
Module width	fig. 3
Weight	930 g
Protection degree	IP 20
Housing material	PA 66

**Product references**

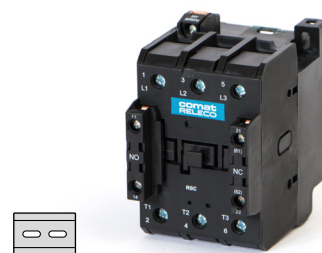
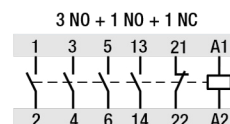
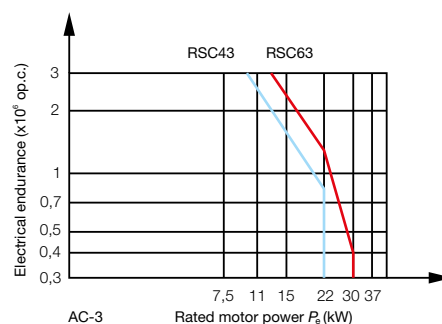
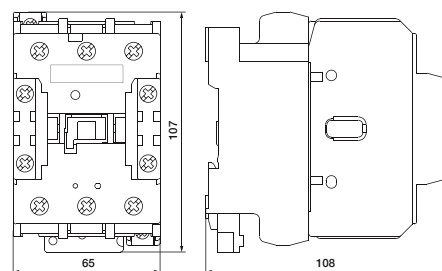
Main circuit	Product reference	24	230
3 NO + 1 NO + 1 NC	RSC63-310/AC...V	✓	✓

"..." list control circuit voltage to complete product references

Other voltages on request. Please contact support@comatreleco.com

**Accessories**

Auxiliary module	RSC-AUX
RC - Suppressor	RSC-RC
DI - Suppressor	RMC-DI
MBL - Mechanical locking	RSC-MBL2

**fig. 1. Wiring diagram****fig. 2. Electrical endurance****fig. 3. Dimensions (mm)****Standards and approvals**

Standards IEC/EN 60947

Approvals

# RSC-MP

**Bimetallic thermal relay | 5 pole | 0.1 ... 10 A | RSC09 ... RSC16**



### Main circuit

Contact material	AgNi
Rated voltage	690 V
Rated current AC-1	0.1 ... 10 A
Rated current auxiliary contact AC / DC	3 A, 230 V / 0.1 A, 230 V
Overload current	72 A (100 ms)
Tripping curve	fig. 2

### Control circuit

Phase loss protection	Yes
Ambient temperature compensation	Yes
Reset mode	manual / automatic
Rated operational current auxiliary contact AC-15	3 A, 250 V

### Insulation

Rated insulation voltage	690 V
Rated impulse withstand voltage	6 kV
Pollution degree	3
Overvoltage category	III

### General data

Ambient temperature storage	-25 ... 70 °C
Ambient temperature operation	-5 ... 55 °C
Conductor cross section Auxiliary / Main Circuit	2.5 mm <sup>2</sup> / 10 mm <sup>2</sup>
Nominal screw torque Auxiliary / Main Circuit	0.8 Nm / 1.2 Nm
Module width	fig. 3
Weight	115 g
Protection degree	IP 20
Housing material	PA 66

### Product references

Description	Product reference
Bimetallic thermal relay	RSC-MP-0.16
Bimetallic thermal relay	RSC-MP-0.25
Bimetallic thermal relay	RSC-MP-0.4
Bimetallic thermal relay	RSC-MP-0.5
Bimetallic thermal relay	RSC-MP-0.63
Bimetallic thermal relay	RSC-MP-0.8
Bimetallic thermal relay	RSC-MP-1.0
Bimetallic thermal relay	RSC-MP-1.3
Bimetallic thermal relay	RSC-MP-1.6
Bimetallic thermal relay	RSC-MP-2.0
Bimetallic thermal relay	RSC-MP-2.5
Bimetallic thermal relay	RSC-MP-3.2
Bimetallic thermal relay	RSC-MP-4.0
Bimetallic thermal relay	RSC-MP-4.8
Bimetallic thermal relay	RSC-MP-6.3
Bimetallic thermal relay	RSC-MP-7.5
Bimetallic thermal relay	RSC-MP-10.0

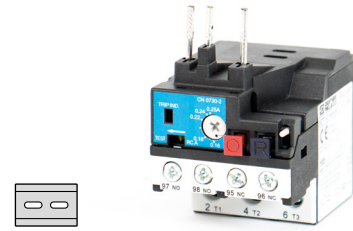


fig. 1. Wiring diagram

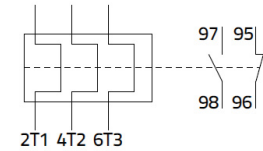


fig. 2. Electrical endurance

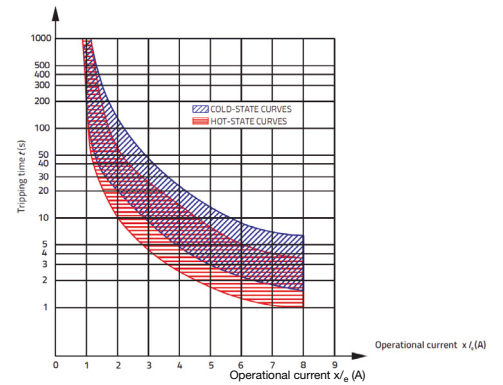
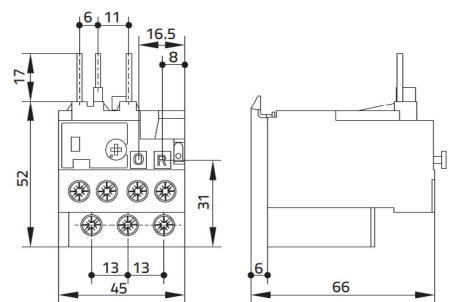


fig. 3. Dimensions (mm)



### Standards and approvals

Standards IEC/EN 60947

Approvals

## RMC-AUX

Auxiliary module for industrial contactors | 2 or 4 pole | 6 A

### Main circuit

Contact material	AgNi
Rated voltage	690 V
Rated current AC-1	20 A
Rated current AC-15	6 A, 230 V
Rated current DC-13	0.15 A, 110 V DC
Minimum contact load	50 mA, 17 V
Mechanical endurance (cycles)	$\geq 1 \times 10^7$
Electrical endurance at rated load AC-15 (cycles)	$\geq 5 \times 10^5$
Electrical endurance at rated load DC-13	$\geq 5 \times 10^5$
Switching frequency at rated load AC-15 (cycles/h)	$\leq 1200$
Switching frequency at rated load DC-13	$\leq 1200$

### Insulation

Rated insulation voltage	690 V
Rated impulse withstand voltage	6 kV
Pollution degree	3

### General data

Ambient temperature storage	-30 ... 80 °C
Conductor cross section Control / Main Circuit	- mm <sup>2</sup> / 2.5 mm <sup>2</sup>
Nominal screw torque Control / Main Circuit	- Nm / 1.2 Nm
Module width	fig. 2
Weight	20 g (2 pole) / 36 g (4 pole)
Protection degree	IP 20
Housing material	PA 66

### Product references

Main circuit	Product reference
2 NO	RMC-AUX20
2 NC	RMC-AUX02
1 NO + 1 NC	RMC-AUX11
4 NO	RMC-AUX40
4 NC	RMC-AUX04
2 NO + 2 NC	RMC-AUX22



fig. 1. Wiring diagram

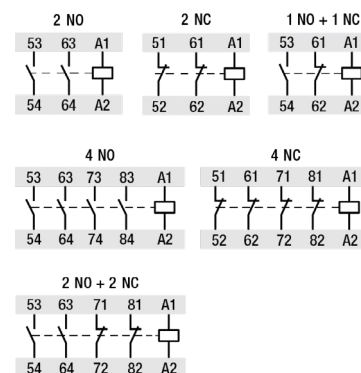
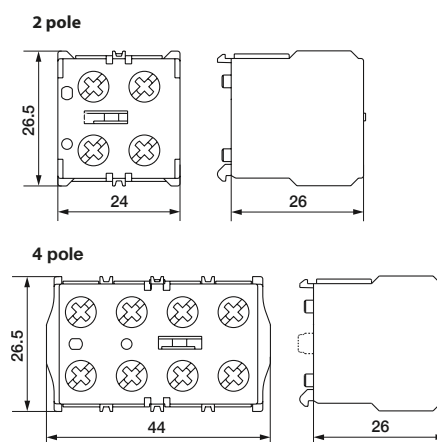


fig. 2. Dimensions (mm)



### Standards and approvals

Standards IEC/EN 60947

Approvals

## RSC-AUX

Auxiliary module for industrial contactors | 2 or 4 pole | 6 A

### Main circuit

Contact material	AgNi
Rated voltage	690 V
Rated current AC-1	20 A
Rated current AC-15	6 A, 230 V
Rated current DC-13	0.15 A, 110 V DC
Minimum contact load	50 mA, 17 V
Mechanical endurance (cycles)	$\geq 1 \times 10^7$
Electrical endurance at rated load AC-15 (cycles)	$\geq 5 \times 10^5$
Electrical endurance at rated load DC-13	$\geq 5 \times 10^5$
Switching frequency at rated load AC-15(cycles/h)	$\leq 1200$
Switching frequency at rated load DC-13	$\leq 1200$

### Insulation

Rated insulation voltage	690 V
Rated impulse withstand voltage	6 kV
Pollution degree	3

### General data

Ambient temperature storage	-30 ... 80 °C
Conductor cross section Control / Main Circuit	- mm <sup>2</sup> / 2.5 mm <sup>2</sup>
Nominal screw torque Control / Main Circuit	- Nm / 1.2 Nm
Module width	fig. 2
Weight	20 g (2 pole) / 36 g (4 pole)
Protection degree	IP 20
Housing material	PA 66

### Product references

Main circuit	Product reference
2 NO	RSC-AUX20
2 NC	RSC-AUX02
1 NO + 1 NC	RSC-AUX11
4 NO	RSC-AUX40
4 NC	RSC-AUX04
2 NO + 2 NC	RSC-AUX22



fig. 1. Wiring diagram

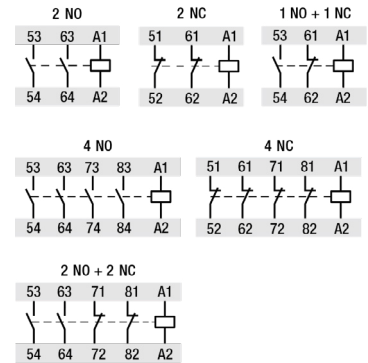
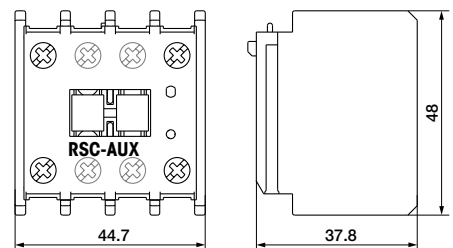


fig. 2. Dimensions (mm)



### Standards and approvals

Standards IEC/EN 60947

Approvals

**RMC-RC****RC - Suppressor****Control circuit**

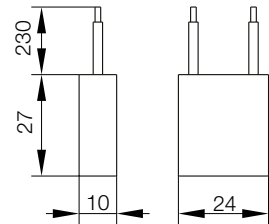
Operating voltage range 12 - 48 V AC / 48 - 250 V AC

**General data**

Module width fig. 1  
Weight 16 g

**Product references**

Description	Product reference
RC - Suppressor 12 - 48 V	RMC-RC1
RC - Suppressor 48 - 250 V	RMC-RC2

**fig. 1. Dimensions (mm)**

**RSC-RC****RC - Suppressor****Control circuit**

Operating voltage range 12 - 48 V AC / 48 - 250 V AC

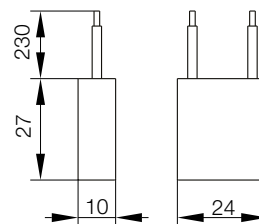
**General data**

Module width fig. 1

Weight 16 g

**Product references**

Description	Product reference
RC - Suppressor 12 - 48 V	RSC-RC1
RC - Suppressor 48 - 250 V	RSC-RC2

**fig. 1. Dimensions (mm)**

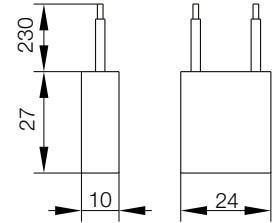


**RMC-DI****DI - Suppressor****Control circuit**

Operating voltage range 6 - 250 V DC

**General data**Module width fig. 1  
Weight 16 g**Product references**

Description	Product reference
RC - Suppressor Diode 6 - 250 V	RMC-DI

**fig. 1. Dimensions (mm)**

## RSC-MBL

### MBL - Mechanical locking

#### General data

Module width	15 mm
Weight	14 g   16 g

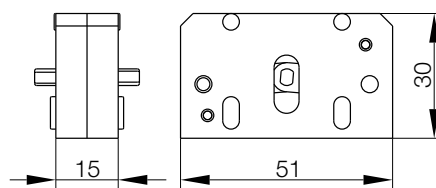
#### Product references

Description	Product reference
RSC - Mechanical locking	RSC-MBL1
RSC - Mechanical locking RSC43 / 63	RSC-MBL2



fig. 1. Dimensions (mm)

RSC-MBL1



RSC-MBL2

on request

## 1.9 Solid State Contactors

Application	Type	Output	Page
<b>CC1 Series</b>			
Solid State Contactor   230 V   15 A	CC1H215	1	132
Solid State Contactor   230 V   30 A	CC1H230	1	133
Solid State Contactor   230 V   50 A	CC1H250	1	134
Solid State Contactor   400 V   15 A	CC1H415	1	135
Solid State Contactor   400 V   30 A	CC1H430	1	136
Solid State Contactor   400 V   50 A	CC1H450	1	137
<b>CC3 Series</b>			
Solid State Contactor   400 V   10 A	CC3H410	3	138
Solid State Contactor   400 V   20 A	CC3H420	3	139
Solid State Contactor   400 V   10 A   Reversing	CCR3H410	3	140
<b>CPC Series</b>			
Solid State Power Controller   230 V   30 A	CPC1230	1	141
Solid State Power Controller   230 V   50 A	CPC1250	1	142
Solid State Power Controller   400 V   30 A	CPC1430	1	143
Solid State Power Controller   400 V   50 A	CPC1450	1	144

# CC1H215

Solid State Contactor | 1 phase | 230 V | 15 A



### Main circuit

Output type	⚡ Thyristor
Number of outputs	1
Rated voltage	230 V
Output voltage range	12 ... 240 V AC
Reverse voltage	1000 Vrrm
Peak reverse voltage	1100 Vrrm
Rated current AC-1	15 A
Rated current AC-3	15 A
Minimum load	10 mA
Typ. leakage current	1 mA
Rated limit load	1800 A <sup>2</sup> t

### Control circuit

Nominal voltage	24 ... 230 V UC
Operating voltage range	0.85 ... 1.1 U <sub>N</sub>
Typ. pick-up voltage	20.4 V
Typ. release voltage	7.2 V
Pick-up time	20 ms
Release time	20 ms
Power consumption AC / DC	1.5 VA / 150 mW
Rated frequency	50 / 60 Hz

### Insulation

Rated insulation voltage	660 V
Rated impulse withstand voltage	4 kV
Pollution degree	3
Overvoltage category	III

### General data

Ambient temperature storage	-20 ... 80 °C
Ambient temperature operation	-5 ... 40 °C
Ambient temperature operation derated power	-5 ... 60 °C, 0.7 I <sub>N</sub>
Conductor cross section Control / Main Circuit	1.5 mm <sup>2</sup> / 10 mm <sup>2</sup>
Nominal screw torque Control / Main Circuit	0.5 Nm / 1.2 Nm
Module width	fig. 2
Weight	270 g
Protection degree	IP 20
Housing material	PPE
Mounting	TS 35 or Back Panel Mounting

### Product references

Description	Product reference
Solid State Contactor, 1 phase	CC1H215

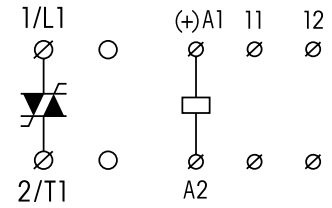
Other devices on request. Please contact [support@comatreleco.com](mailto:support@comatreleco.com).

### Accessories

Thermal overload protection	P82-100C
-----------------------------	----------

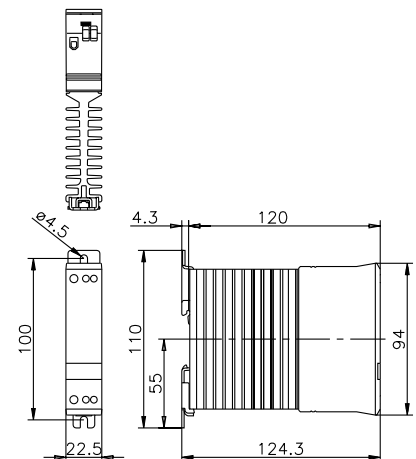


fig. 1. Wiring diagram



11-12: Thermostat

fig. 2. Dimensions (mm)



### Standards and approvals

Standards IEC/EN 60947, 50022, 60068

Approvals

## 1.9 Solid State Contactors

**CC1H230**
**Solid State Contactor | 1 phase | 230 V | 30 A**
**Main circuit**

Output type	⚡ Thyristor
Number of outputs	1
Rated voltage	230 V
Output voltage range	12 ... 240 V AC
Reverse voltage	1000 Vrrm
Peak reverse voltage	1100 Vrrm
Rated current AC-1	30 A
Rated current AC-3	15 A
Minimum load	10 mA
Typ. leakage current	1 mA
Rated limit load	1800 A <sup>2</sup> t

**Control circuit**

Nominal voltage	24 ... 230 V UC
Operating voltage range	0.85 ... 1.1 U <sub>N</sub>
Typ. pick-up voltage	20.4 V
Typ. release voltage	7.2 V
Pick-up time	20 ms
Release time	20 ms
Power consumption AC / DC	1.5 VA / 150 mW
Rated frequency	50 / 60 Hz

**Insulation**

Rated insulation voltage	660 V
Rated impulse withstand voltage	4 kV
Pollution degree	3
Overvoltage category	III

**General data**

Ambient temperature storage	-20 ... 80 °C
Ambient temperature operation	-5 ... 40 °C
Ambient temperature operation derated power	-5 ... 60 °C, 0.7 I <sub>N</sub>
Conductor cross section Control / Main Circuit	1.5 mm <sup>2</sup> / 10 mm <sup>2</sup>
Nominal screw torque Control / Main Circuit	0.5 Nm / 1.2 Nm
Module width	fig. 2
Weight	650 g
Protection degree	IP 20
Housing material	PPE
Mounting	TS 35 or Back Panel Mounting

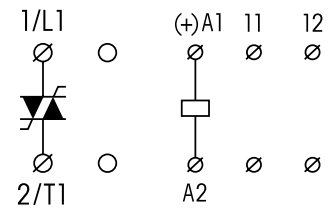
**Product references**

Description	Product reference
Solid State Contactor, 1 phase	CC1H230

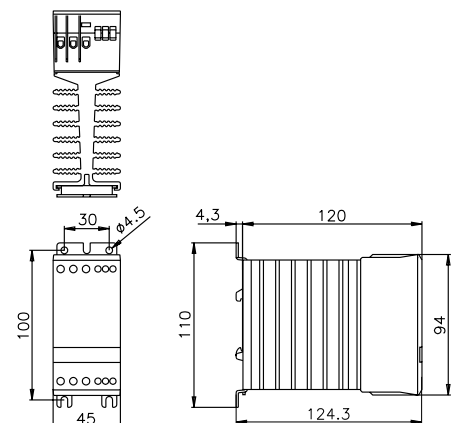
 Other devices on request. Please contact [support@comatreleco.com](mailto:support@comatreleco.com).

**Accessories**

Thermal overload protection	P82-100C
-----------------------------	----------


**fig. 1. Wiring diagram**


11-12: Thermostat

**fig. 2. Dimensions (mm)**

**Standards and approvals**

Standards IEC/EN 60947, 50022, 60068

Approvals

# CC1H250

Solid State Contactor | 1 phase | 230 V | 50 A



### Main circuit

Output type	⚡ Thyristor
Number of outputs	1
Rated voltage	230 V
Output voltage range	12 ... 240 V AC
Reverse voltage	1000 Vrrm
Peak reverse voltage	1100 Vrrm
Rated current AC-1	50 A
Rated current AC-3	15 A
Minimum load	10 mA
Typ. leakage current	1 mA
Rated limit load	1800 A <sup>2</sup> t

### Control circuit

Nominal voltage	24 ... 230 V UC
Operating voltage range	0.85 ... 1.1 U <sub>N</sub>
Typ. pick-up voltage	20.4 V
Typ. release voltage	7.2 V
Pick-up time	20 ms
Release time	20 ms
Power consumption AC / DC	1.5 VA / 150 mW
Rated frequency	50 / 60 Hz

### Insulation

Rated insulation voltage	660 V
Rated impulse withstand voltage	4 kV
Pollution degree	3
Overvoltage category	III

### General data

Ambient temperature storage	-20 ... 80 °C
Ambient temperature operation	-5 ... 40 °C
Ambient temperature operation derated power	-5 ... 60 °C, 0.7 I <sub>N</sub>
Conductor cross section Control / Main Circuit	1.5 mm <sup>2</sup> / 10 mm <sup>2</sup>
Nominal screw torque Control / Main Circuit	0.5 Nm / 1.2 Nm
Module width	fig. 2
Weight	1050 g
Protection degree	IP 20
Housing material	PPE
Mounting	TS 35 or Back Panel Mounting

### Product references

Description	Product reference
Solid State Contactor, 1 phase	CC1H250

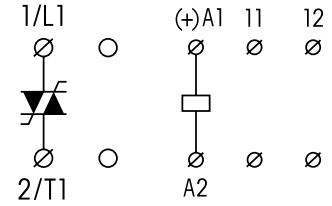
Other devices on request. Please contact [support@comatreleco.com](mailto:support@comatreleco.com).

### Accessories

Thermal overload protection	P82-100C
-----------------------------	----------

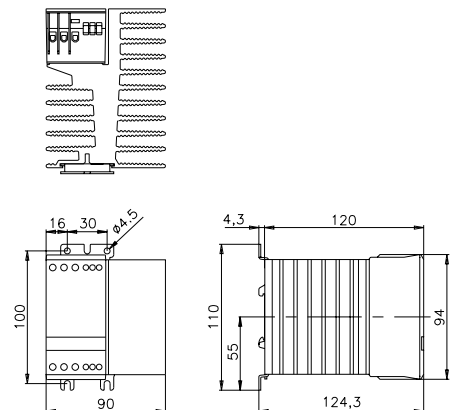


fig. 1. Wiring diagram



11-12: Thermostat

fig. 2. Dimensions (mm)



### Standards and approvals

Standards IEC/EN 60947, 50022, 60068

Approvals

**CC1H415****Solid State Contactor | 1 phase | 400 V | 15 A****Main circuit**

Output type	⚡ Thyristor
Number of outputs	1
Rated voltage	400 V
Output voltage range	24 ... 480 VAC
Reverse voltage	1200 V <sub>rrm</sub>
Peak reverse voltage	1300 V <sub>rrm</sub>
Rated current AC-1	15 A
Rated current AC-3	15 A
Minimum load	10 mA
Typ. leakage current	1 mA
Rated limit load	1800 A <sup>2</sup> t

**Control circuit**

Nominal voltage	24 ... 230 V UC
Operating voltage range	0.85 ... 1.1 U <sub>N</sub>
Typ. pick-up voltage	20.4 V
Typ. release voltage	7.2 V
Pick-up time	20 ms
Release time	20 ms
Power consumption AC / DC	1.5 VA / 150 mW
Rated frequency	50 / 60 Hz

**Insulation**

Rated insulation voltage	660 V
Rated impulse withstand voltage	4 kV
Pollution degree	3
Overvoltage category	III

**General data**

Ambient temperature storage	-20 ... 80 °C
Ambient temperature operation	-5 ... 40 °C
Ambient temperature operation derated power	-5 ... 60 °C, 0.7 I <sub>N</sub>
Conductor cross section Control / Main Circuit	1.5 mm <sup>2</sup> / 10 mm <sup>2</sup>
Nominal screw torque Control / Main Circuit	0.5 Nm / 1.2 Nm
Module width	fig. 2
Weight	270 g
Protection degree	IP 20
Housing material	PPE
Mounting	TS 35 or Back Panel Mounting

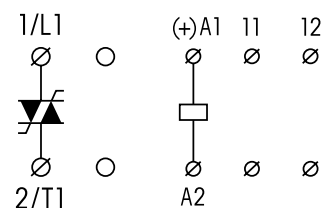
**Product references**

Description	Product reference
Solid State Contactor, 1 phase	CC1H415

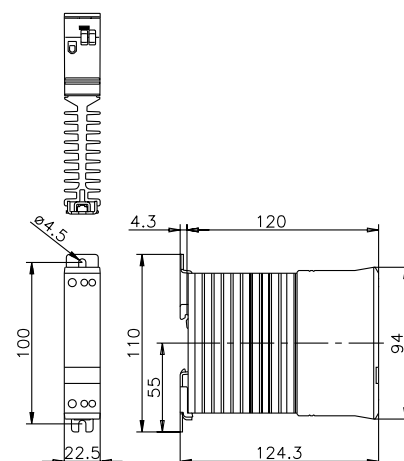
Other devices on request. Please contact [support@comatreleco.com](mailto:support@comatreleco.com).

**Accessories**

Thermal overload protection	P82-100C
-----------------------------	----------

**fig. 1. Wiring diagram**

11-12: Thermostat

**fig. 2. Dimensions (mm)****Standards and approvals**

Standards IEC/EN 60947, 50022, 60068

Approvals

# CC1H430

Solid State Contactor | 1 phase | 400 V | 30 A



### Main circuit

Output type	⚡ Thyristor
Number of outputs	1
Rated voltage	400 V
Output voltage range	24 ... 480 VAC
Reverse voltage	1200 Vrrm
Peak reverse voltage	1300 Vrrm
Rated current AC-1	30 A
Rated current AC-3	15 A
Minimum load	10 mA
Typ. leakage current	1 mA
Rated limit load	1800 A <sup>2</sup> t

### Control circuit

Nominal voltage	24 ... 230 V UC
Operating voltage range	0.85 ... 1.1 U <sub>N</sub>
Typ. pick-up voltage	20.4 V
Typ. release voltage	7.2 V
Pick-up time	20 ms
Release time	20 ms
Power consumption AC / DC	1.5 VA / 150 mW
Rated frequency	50 / 60 Hz

### Insulation

Rated insulation voltage	660 V
Rated impulse withstand voltage	4 kV
Pollution degree	3
Overvoltage category	III

### General data

Ambient temperature storage	-20 ... 80 °C
Ambient temperature operation	-5 ... 40 °C
Ambient temperature operation derated power	-5 ... 60 °C, 0.7 I <sub>N</sub>
Conductor cross section Control / Main Circuit	1.5 mm <sup>2</sup> / 10 mm <sup>2</sup>
Nominal screw torque Control / Main Circuit	0.5 Nm / 1.2 Nm
Module width	fig. 2
Weight	650 g
Protection degree	IP 20
Housing material	PPE
Mounting	TS 35 or Back Panel Mounting

### Product references

Description	Product reference
Solid State Contactor, 1 phase	CC1H430

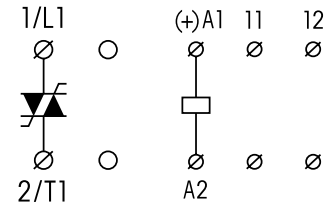
Other devices on request. Please contact [support@comatreleco.com](mailto:support@comatreleco.com).

### Accessories

Thermal overload protection	P82-100C
-----------------------------	----------

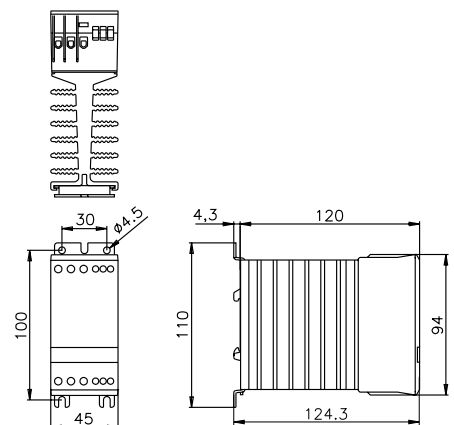


fig. 1. Wiring diagram



11-12: Thermostat

fig. 2. Dimensions (mm)



### Standards and approvals

Standards IEC/EN 60947, 50022, 60068

Approvals



**CC1H450****Solid State Contactor | 1 phase | 400 V | 50 A****Main circuit**

Output type	⚡ Thyristor
Number of outputs	1
Rated voltage	400 V
Output voltage range	24 ... 480 VAC
Reverse voltage	1200 V <sub>rrm</sub>
Peak reverse voltage	1300 V <sub>rrm</sub>
Rated current AC-1	50 A
Rated current AC-3	15 A
Minimum load	10 mA
Typ. leakage current	1 mA
Rated limit load	1800 A <sup>2</sup> t

**Control circuit**

Nominal voltage	24 ... 230 V UC
Operating voltage range	0.85 ... 1.1 U <sub>N</sub>
Typ. pick-up voltage	20.4 V
Typ. release voltage	7.2 V
Pick-up time	20 ms
Release time	20 ms
Power consumption AC / DC	1.5 VA / 150 mW
Rated frequency	50 / 60 Hz

**Insulation**

Rated insulation voltage	660 V
Rated impulse withstand voltage	4 kV
Pollution degree	3
Overvoltage category	III

**General data**

Ambient temperature storage	-20 ... 80 °C
Ambient temperature operation	-5 ... 40 °C
Ambient temperature operation derated power	-5 ... 60 °C, 0.7 I <sub>N</sub>
Conductor cross section Control / Main Circuit	1.5 mm <sup>2</sup> / 10 mm <sup>2</sup>
Nominal screw torque Control / Main Circuit	0.5 Nm / 1.2 Nm
Module width	fig. 2
Weight	1050 g
Protection degree	IP 20
Housing material	PPE
Mounting	TS 35 or Back Panel Mounting

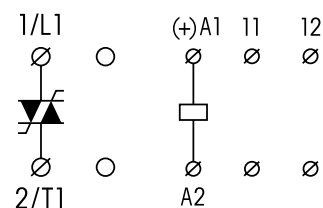
**Product references**

Description	Product reference
Solid State Contactor, 1 phase	CC1H450

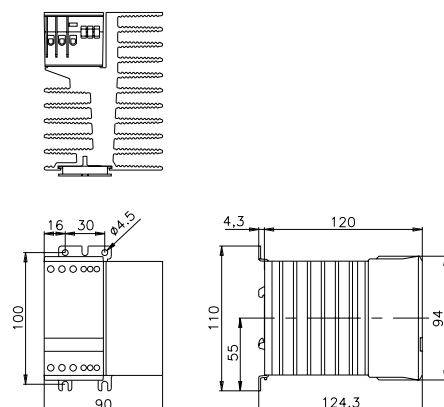
Other devices on request. Please contact [support@comatreleco.com](mailto:support@comatreleco.com).

**Accessories**

Thermal overload protection	P82-100C
-----------------------------	----------

**fig. 1. Wiring diagram**

11-12: Thermostat

**fig. 2. Dimensions (mm)****Standards and approvals**

Standards IEC/EN 60947, 50022, 60068

Approvals

# CC3H410

Solid State Contactor | 3 phase | 400 V | 10 A



**Main circuit**

Output type	⚡ Thyristor
Number of outputs	3
Rated voltage	400 V
Output voltage range	24 ... 480 VAC
Reverse voltage	1200 Vrrm
Peak reverse voltage	1300 Vrrm
Rated current AC-1	10 A
Rated current AC-3	10 A
Minimum load	10 mA
Typ. leakage current	1 mA
Rated limit load	610 A <sup>2</sup> t

**Control circuit**

Nominal voltage	24 ... 230 V UC
Operating voltage range	0.85 ... 1.1 U <sub>N</sub>
Typ. pick-up voltage	20.4 V
Typ. release voltage	7.2 V
Pick-up time	20 ms
Release time	20 ms
Power consumption AC / DC	1.5 VA / 150 mW
Rated frequency	50 / 60 Hz

**Insulation**

Rated insulation voltage	660 V
Rated impulse withstand voltage	4 kV
Pollution degree	3
Overvoltage category	III

**General data**

Ambient temperature storage	-20 ... 80 °C
Ambient temperature operation	-5 ... 40 °C
Ambient temperature operation derated power	-5 ... 60 °C, 0.7 I <sub>N</sub>
Conductor cross section Control / Main Circuit	1.5 mm <sup>2</sup> / 10 mm <sup>2</sup>
Nominal screw torque Control / Main Circuit	0.5 Nm / 1.2 Nm
Module width	fig. 2
Weight	650 g
Protection degree	IP 20
Housing material	PPE
Mounting	TS 35 or Back Panel Mounting

**Product references**

Description	Product reference
Solid State Contactor, 3 phase	CC3H410

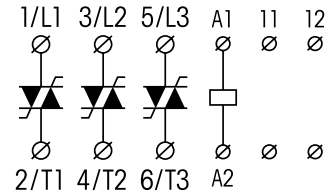
Other devices on request. Please contact [support@comatreleco.com](mailto:support@comatreleco.com).

**Accessories**

Thermal overload protection	P82-100C
-----------------------------	----------

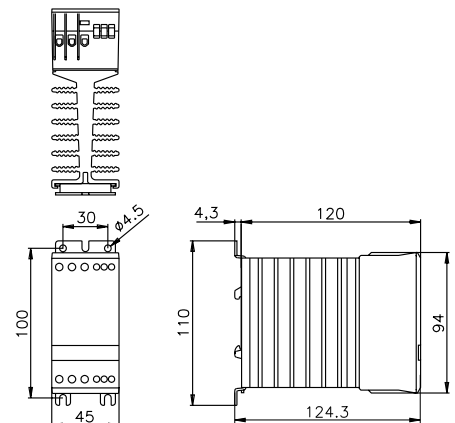


fig. 1. Wiring diagram



11-12: Thermostat

fig. 2. Dimensions (mm)



**Standards and approvals**

Standards IEC/EN 60947, 50022, 60068

Approvals

**CC3H420****Solid State Contactor | 3 phase | 400 V | 20 A****Main circuit**

Output type	⚡ Thyristor
Number of outputs	3
Rated voltage	400 V
Output voltage range	24 ... 480 VAC
Reverse voltage	1200 V <sub>rrm</sub>
Peak reverse voltage	1300 V <sub>rrm</sub>
Rated current AC-1	20 A
Rated current AC-3	10 A
Minimum load	10 mA
Typ. leakage current	1 mA
Rated limit load	610 A <sup>2</sup> t

**Control circuit**

Nominal voltage	24 ... 230 V UC
Operating voltage range	0.85 ... 1.1 U <sub>N</sub>
Typ. pick-up voltage	20.4 V
Typ. release voltage	7.2 V
Pick-up time	20 ms
Release time	20 ms
Power consumption AC / DC	1.5 VA / 150 mW
Rated frequency	50 / 60 Hz

**Insulation**

Rated insulation voltage	660 V
Rated impulse withstand voltage	4 kV
Pollution degree	3
Overvoltage category	III

**General data**

Ambient temperature storage	-20 ... 80 °C
Ambient temperature operation	-5 ... 40 °C
Ambient temperature operation derated power	-5 ... 60 °C, 0.7 I <sub>N</sub>
Conductor cross section Control / Main Circuit	1.5 mm <sup>2</sup> / 10 mm <sup>2</sup>
Nominal screw torque Control / Main Circuit	0.5 Nm / 1.2 Nm
Module width	fig. 2
Weight	1050 g
Protection degree	IP 20
Housing material	PPE
Mounting	TS 35 or Back Panel Mounting

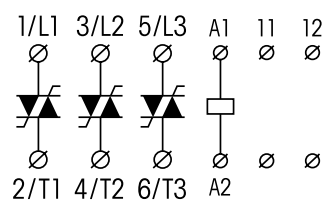
**Product references**

Description	Product reference
Solid State Contactor, 3 phase	CC3H420

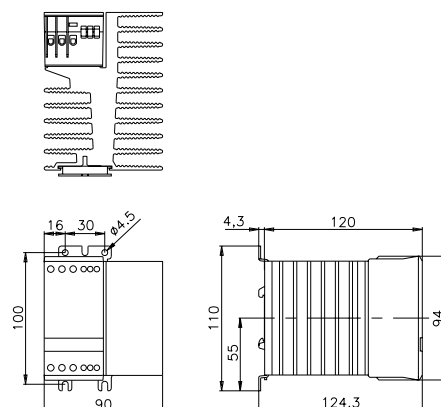
Other devices on request. Please contact [support@comatreleco.com](mailto:support@comatreleco.com).

**Accessories**

Thermal overload protection	P82-100C
-----------------------------	----------

**fig. 1. Wiring diagram**

11-12: Thermostat

**fig. 2. Dimensions (mm)****Standards and approvals**

Standards IEC/EN 60947, 50022, 60068

Approvals

## CCR3H410

Solid State Contactor | Reversing | 3 phase | 400 V | 10 A

### Main circuit

Output type	⚡ Thyristor
Number of outputs	3
Rated voltage	400 V
Output voltage range	24 ... 480 VAC
Reverse voltage	1200 Vrrm
Peak reverse voltage	1300 Vrrm
Rated current AC-1	10 A
Rated current AC-3	10 A
Minimum load	10 mA
Typ. leakage current	1 mA
Rated limit load	610 A <sup>2</sup> t

### Control circuit

Nominal voltage	24 ... 230 V UC
Operating voltage range	0.85 ... 1.1 U <sub>N</sub>
Typ. pick-up voltage	20.4 V
Typ. release voltage	7.2 V
Pick-up time	20 ms
Release time	20 ms
Interlock time	150 ms
Power consumption AC / DC	1.5 VA / 150 mW
Rated frequency	50 / 60 Hz

### Insulation

Rated insulation voltage	660 V
Rated impulse withstand voltage	4 kV
Pollution degree	3
Overtoltage category	III

### General data

Ambient temperature storage	-20 ... 80 °C
Ambient temperature operation	-5 ... 40 °C
Ambient temperature operation derated power	-5 ... 60 °C, 0.7 I <sub>N</sub>
Conductor cross section Control / Main Circuit	1.5 mm <sup>2</sup> / 10 mm <sup>2</sup>
Nominal screw torque Control / Main Circuit	0.5 Nm / 1.2 Nm
Module width	fig. 2
Weight	650 g
Protection degree	IP 20
Housing material	PPE
Mounting	TS 35 or Back Panel Mounting

### Product references

Description	Product reference
Solid State Contactor - Reversing, 3 phase	CCR3H410

Other devices on request. Please contact [support@comatreleco.com](mailto:support@comatreleco.com).

### Accessories

Thermal overload protection	P82-100C
-----------------------------	----------

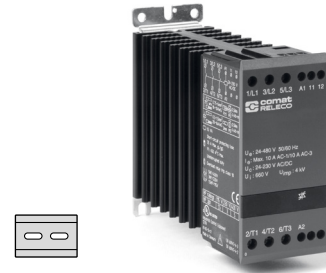
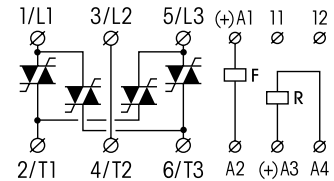
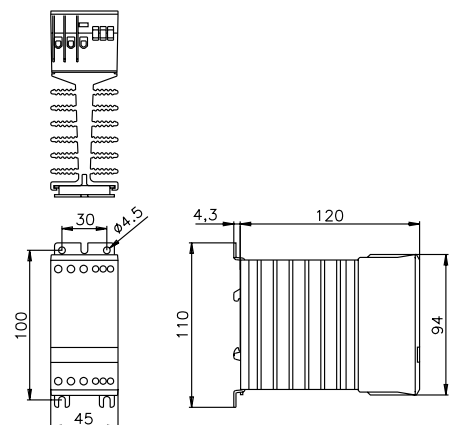


fig. 1. Wiring diagram



11-12: Thermostat

fig. 2. Dimensions (mm)



### Standards and approvals

Standards IEC/EN 60947, 50022, 60068

Approvals

**CPC1230****Solid State Power Controller | 1 phase | 230 V | 30 A****Main circuit**

Output type	⚡ Thyristor
Number of outputs	1
Rated voltage	230 V
Output voltage range	380 ... 480 V
Reverse voltage	1000 V <sub>rrm</sub>
Peak reverse voltage	1100 V <sub>rrm</sub>
Rated current AC-1	30 A
Minimum load	10 mA
Typ. leakage current	1 mA
Rated limit load	1800 A <sup>2</sup> t

**Control circuit**

Nominal voltage	24 V UC
Operating voltage range	0.5 ... 1.5 U <sub>N</sub>
Typ. pick-up voltage	≤ 12 V
Typ. release voltage	≥ 12 V
Pick-up time	20 ms
Release time	20 ms
Control input	0 ... 20 mA / 4 ... 20 mA / 0 - 10 V
Potentiometer_input	0 - 10 kOhm

**Insulation**

Rated insulation voltage	660 V
Rated impulse withstand voltage	4 kV
Pollution degree	3
Overvoltage category	III

**General data**

Ambient temperature storage	-20 ... 80 °C
Ambient temperature operation	-5 ... 40 °C
Ambient temperature operation derated power	-5 ... 60 °C, 0.7 I <sub>N</sub>
Conductor cross section Control / Main Circuit	1.5 mm <sup>2</sup> / 10 mm <sup>2</sup>
Nominal screw torque Control / Main Circuit	0.5 Nm / 1.2 Nm
Module width	fig. 2
Weight	650 g
Protection degree	IP 20
Housing material	PPE
Mounting	TS 35 or Back Panel Mounting

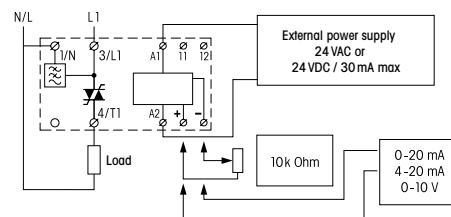
**Product references**

Description	Product reference
Power Controller, 1 phase	CPC1230

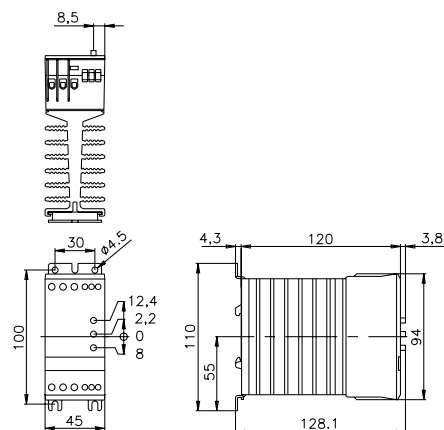
Other devices on request. Please contact [support@comatreleco.com](mailto:support@comatreleco.com).

**Accessories**

Thermal overload protection	P82-100C
-----------------------------	----------

**fig. 1. Wiring diagram**

11-12: Thermostat

**fig. 2. Dimensions (mm)****Standards and approvals**

Standards IEC/EN 60947, 50022, 60068

Approvals

### CPC1250

Solid State Power Controller | 1 phase | 230 V | 50 A

#### Main circuit

Output type	⚡ Thyristor
Number of outputs	1
Rated voltage	230 V
Output voltage range	380 ... 480 V
Reverse voltage	1000 Vrrm
Peak reverse voltage	1100 Vrrm
Rated current AC-1	50 A
Minimum load	10 mA
Typ. leakage current	1 mA
Rated limit load	1800 A <sup>2</sup> t

#### Control circuit

Nominal voltage	24 V UC
Operating voltage range	0.5 ... 1.5 U <sub>N</sub>
Typ. pick-up voltage	≤ 12 V
Typ. release voltage	≥ 12 V
Pick-up time	20 ms
Release time	20 ms
Control input	0 ... 20 mA / 4 ... 20 mA / 0 - 10 V
Potentiometer_input	0 - 10 kOhm

#### Insulation

Rated insulation voltage	660 V
Rated impulse withstand voltage	4 kV
Pollution degree	3
Overvoltage category	III

#### General data

Ambient temperature storage	-20 ... 80 °C
Ambient temperature operation	-5 ... 40 °C
Ambient temperature operation derated power	-5 ... 60 °C, 0.7 I <sub>N</sub>
Conductor cross section Control / Main Circuit	1.5 mm <sup>2</sup> / 10 mm <sup>2</sup>
Nominal screw torque Control / Main Circuit	0.5 Nm / 1.2 Nm
Module width	fig. 2
Weight	650 g
Protection degree	IP 20
Housing material	PPE
Mounting	TS 35 or Back Panel Mounting

#### Product references

Description	Product reference
Power Controller, 1 phase	CPC1250

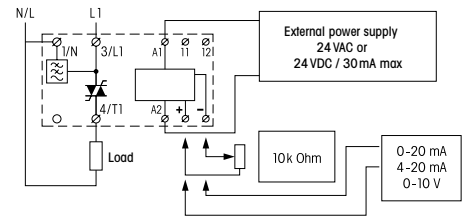
Other devices on request. Please contact [support@comatreleco.com](mailto:support@comatreleco.com).

#### Accessories

Thermal overload protection	P82-100C
-----------------------------	----------

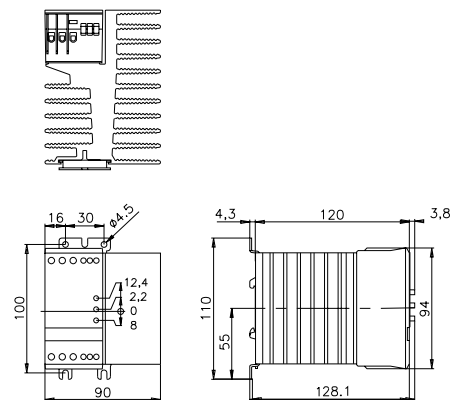


fig. 1. Wiring diagram



11-12: Thermostat

fig. 2. Dimensions (mm)



#### Standards and approvals

Standards IEC/EN 60947, 50022, 60068

Approvals

## CPC1430

### Solid State Power Controller | 1 phase | 400 V | 30 A

#### Main circuit

Output type	⚡ Thyristor
Number of outputs	1
Rated voltage	400 V
Output voltage range	380 ... 480 V
Reverse voltage	1200 V <sub>rrm</sub>
Peak reverse voltage	1300 V <sub>rrm</sub>
Rated current AC-1	30 A
Minimum load	10 mA
Typ. leakage current	1 mA
Rated limit load	1800 A <sup>2</sup> t

#### Control circuit

Nominal voltage	24 V UC
Operating voltage range	0.5 ... 1.5 U <sub>N</sub>
Typ. pick-up voltage	≤ 12 V
Typ. release voltage	≥ 12 V
Pick-up time	20 ms
Release time	20 ms
Control input	0 ... 20 mA / 4 ... 20 mA / 0 - 10 V
Potentiometer_input	0 - 10 kOhm

#### Insulation

Rated insulation voltage	660 V
Rated impulse withstand voltage	4 kV
Pollution degree	3
Overvoltage category	III

#### General data

Ambient temperature storage	-20 ... 80 °C
Ambient temperature operation	-5 ... 40 °C
Ambient temperature operation derated power	-5 ... 60 °C, 0.7 I <sub>N</sub>
Conductor cross section Control / Main Circuit	1.5 mm <sup>2</sup> / 10 mm <sup>2</sup>
Nominal screw torque Control / Main Circuit	0.5 Nm / 1.2 Nm
Module width	fig. 2
Weight	650 g
Protection degree	IP 20
Housing material	PPE
Mounting	TS 35 or Back Panel Mounting

#### Product references

Description	Product reference
Power Controller, 1 phase	CPC1430

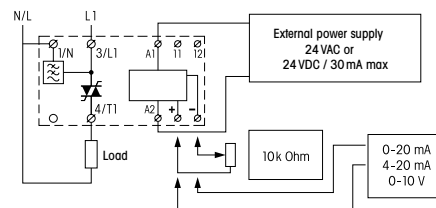
Other devices on request. Please contact [support@comatreleco.com](mailto:support@comatreleco.com).

#### Accessories

Thermal overload protection	P82-100C
-----------------------------	----------

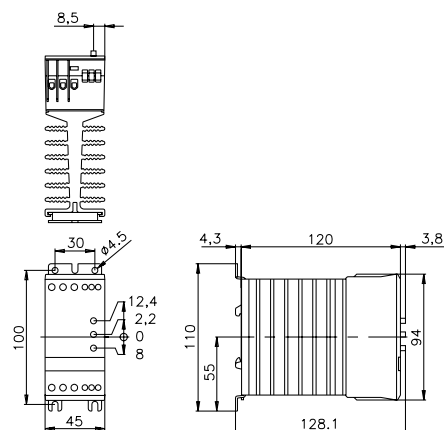


fig. 1. Wiring diagram



11-12: Thermostat

fig. 2. Dimensions (mm)



#### Standards and approvals

Standards IEC/EN 60947, 50022, 60068

Approvals

**CPC1450**

**Solid State Power Controller | 1 phase | 400 V | 50 A**



**Main circuit**

Output type	⚡ Thyristor
Number of outputs	1
Rated voltage	400 V
Output voltage range	380 ... 480 V
Reverse voltage	1200 Vrrm
Peak reverse voltage	1300 Vrrm
Rated current AC-1	50 A
Minimum load	10 mA
Typ. leakage current	1 mA
Rated limit load	1800 A <sup>2</sup> t

**Control circuit**

Nominal voltage	24 V UC
Operating voltage range	0.5 ... 1.5 U <sub>N</sub>
Typ. pick-up voltage	≤ 12 V
Typ. release voltage	≥ 12 V
Pick-up time	20 ms
Release time	20 ms
Control input	0 ... 20 mA / 4 ... 20 mA / 0 - 10 V
Potentiometer_input	0 - 10 kOhm

**Insulation**

Rated insulation voltage	660 V
Rated impulse withstand voltage	4 kV
Pollution degree	3
Overvoltage category	III

**General data**

Ambient temperature storage	-20 ... 80 °C
Ambient temperature operation	-5 ... 40 °C
Ambient temperature operation derated power	-5 ... 60 °C, 0.7 I <sub>N</sub>
Conductor cross section Control / Main Circuit	1.5 mm <sup>2</sup> / 10 mm <sup>2</sup>
Nominal screw torque Control / Main Circuit	0.5 Nm / 1.2 Nm
Module width	fig. 2
Weight	650 g
Protection degree	IP 20
Housing material	PPE
Mounting	TS 35 or Back Panel Mounting

**Product references**

Description	Product reference
Power Controller, 1 phase	CPC1450

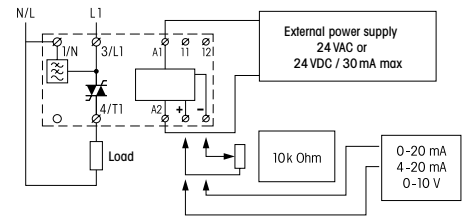
Other devices on request. Please contact [support@comatreleco.com](mailto:support@comatreleco.com).

**Accessories**

Thermal overload protection	P82-100C
-----------------------------	----------

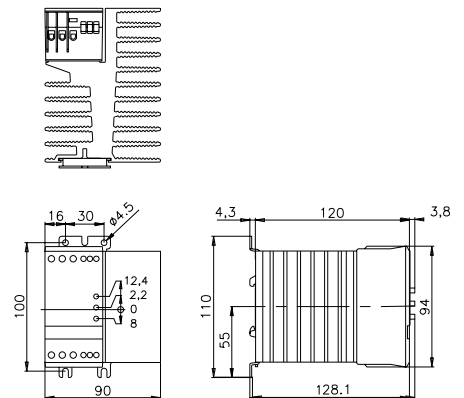


**fig. 1. Wiring diagram**



11-12: Thermostat

**fig. 2. Dimensions (mm)**



**Standards and approvals**

Standards IEC/EN 60947, 50022, 60068

Approvals



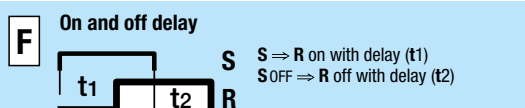
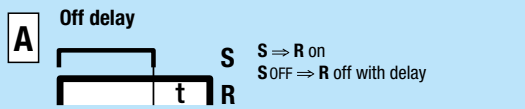
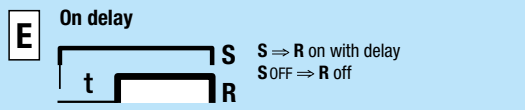




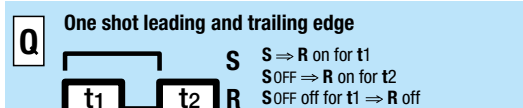
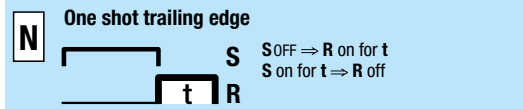
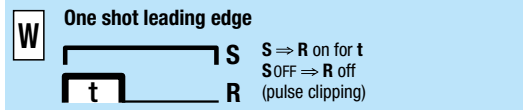
## 2 Time Relays

---

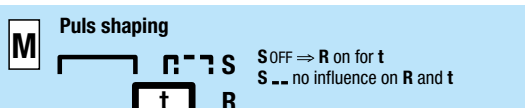
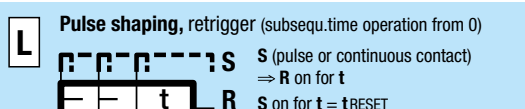
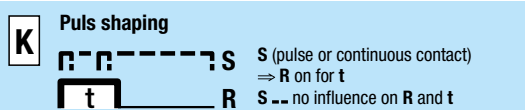
## Delay functions



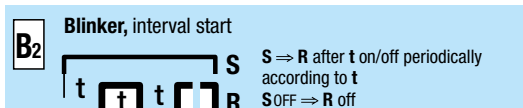
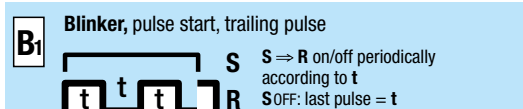
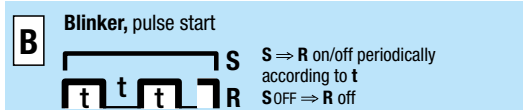
## Shot timing modes



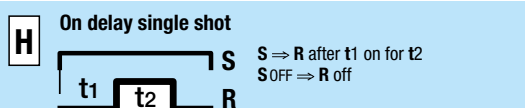
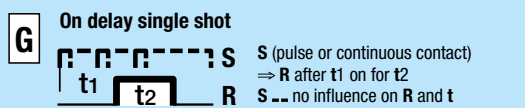
## Puls shaping



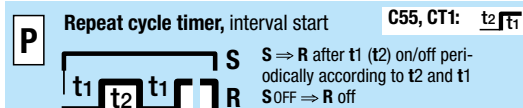
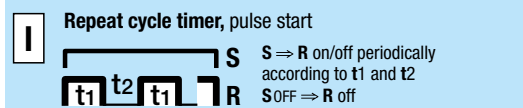
## Blinker functions



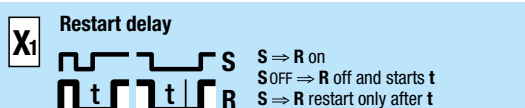
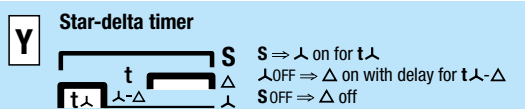
## Delayed pulse



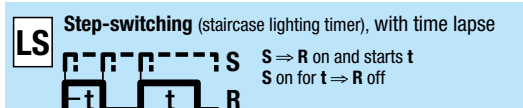
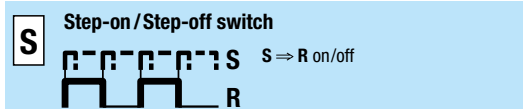
## Repeat cycle timer



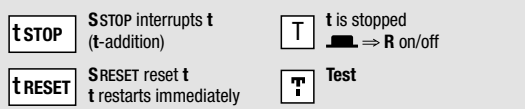
## Special functions



## Special functions



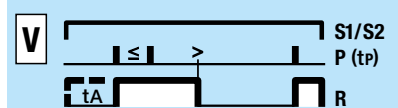
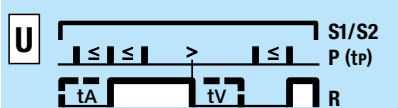
## Stop / Reset



S = Triggering  
R = Output circuit  
 $\Rightarrow$  = switches...



## Pulse sequence monitoring



S1/S2 = Monitoring start  
P = Pulse sequence  
tp = Pulse separation

$\leq$ : Pulse separation is **smaller** than the time tp  
 $>$ : Pulse separation is **larger** than the time tp

Start with S1 = **without** start-up short-out tA  
Start with S2 = start-up short-out tA

tv = settable alarm delay  
delay (tA = tv)





## 2.1 ON and OFF delay Relays

Application	Type	Page
<b>CMD Series</b>		
Off delay   single voltage   1 CO	CMD11-A	152
On delay   single voltage   1 CO	CMD11-E	153
<b>AA2, AA2M Series</b>		
Off delay   24 V UC   220 ... 240 V AC   1 CO	AA2, AA2M	154
<b>AE2, AE2M Series</b>		
On delay   24 V UC   220 ... 240 V AC   1 CO	AE2, AE2M	155

**CMD11-A****Off delay | single voltage | 1 CO****Time data**

Timing functions	A
Timing range	50 ms ... 60 min
Timing scale	0.6 s / 6 s / 60 s / 6 min / 60 min

**Main circuit**

Number of contacts	1 CO
Contact Material	AgNi
Rated voltage	250 V AC
Rated current	8 A
Minimum load	10 mA, 12 V
Inrush current	15 A, 20 ms
Rated load DC	fig. 2
Rated load AC-1	2000 VA
Mechanical endurance (cycles)	$3 \times 10^7$
Electrical endurance at rated load AC-1 (cycles)	fig. 3

**Control circuit**

Nominal voltage	12 V UC	24 V UC	115 V AC	230 V AC
Operating voltage range	0.8 ... 1.2 U <sub>N</sub>	0.8 ... 1.2 U <sub>N</sub>	0.8 ... 1.2 U <sub>N</sub>	0.8 ... 1.2 U <sub>N</sub>
Power consumption AC / DC	50 / 32 mA	21 / 12 mA	47 mA / -	60 mA / -
Typ. input current on command input AC / DC	2.7 / 4.3 mA	11.6 / 9.5 mA	1.7 mA / -	1.9 mA / -
Typ. threshold voltage on command input AC / DC	5.2 / 8.8 V	9.5 / 14 V	42 V / -	80 V / -
Rated frequency	48 ... 62 Hz	48 ... 62 Hz	48 ... 62 Hz	48 ... 62 Hz

**Insulation**

Rated test voltage control / main circuit	2 kV rms / 1 min
Rated test voltage open contact	1 kV rms / 1 min
Pollution degree	2
Overvoltage category	III

**General data**

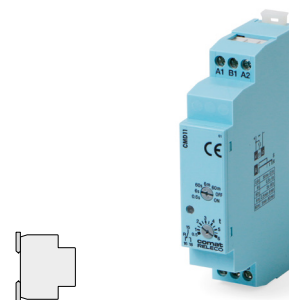
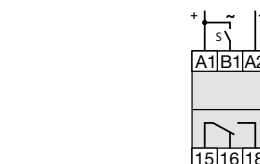
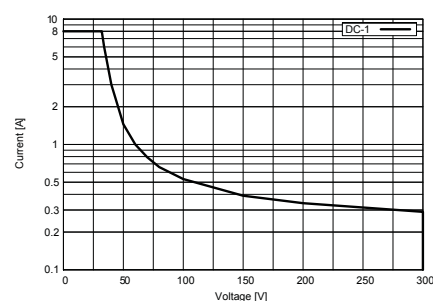
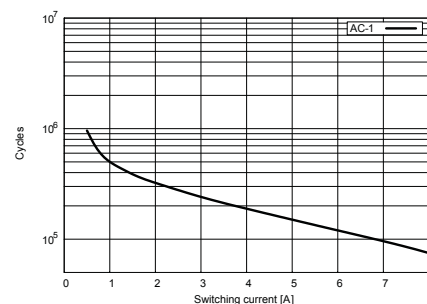
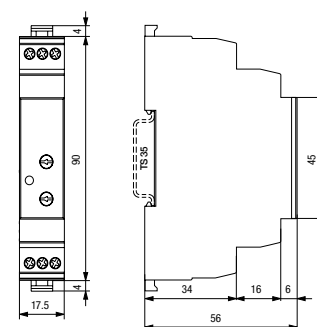
Ambient temperature storage	-40 ... 85 °C
Ambient temperature operation	-40 ... 60 °C
Conductor cross section	2.5 mm <sup>2</sup> , 2 x 1.5 mm <sup>2</sup>
Nominal screw torque	0.5 Nm
Module width	fig. 4
Weight	48 g
Protection degree	IP 20
Housing material	PA 66

**Product references**

Types	Product reference	12	24	115	230
UC supply	CMD11-A/UC...V	✓	✓		
AC supply	CMD11-A/AC...V			✓	✓

"..." list control circuit voltage to complete product references.

Other voltages on request. Please contact [support@comatreleco.com](mailto:support@comatreleco.com).

**fig. 1. Wiring diagram****fig. 2. DC load limit curve****fig. 3. AC voltage endurance****fig. 4. Dimensions (mm)****Standards and approvals**

Standards IEC/EN 60947

Approvals





# CMD11-E

On delay | single voltage | 1 CO

### Time data

Timing functions	E
Timing range	50 ms ... 60 min
Timing scale	0.6 s / 6 s / 60 s / 6 min / 60 min

### Main circuit

Number of contacts	1 CO
Contact Material	AgNi
Rated voltage	250 V AC
Rated current	8 A
Minimum load	10 mA, 12 V
Inrush current	15 A, 20 ms
Rated load DC	fig. 2
Rated load AC-1	2000 VA
Mechanical endurance (cycles)	$3 \times 10^7$
Electrical endurance at rated load AC-1 (cycles)	fig. 3

### Control circuit

Nominal voltage	12 V UC	24 V UC	115 V AC	230 V AC
Operating voltage range	$0.8 \dots 1.2 U_N$	$0.8 \dots 1.2 U_N$	$0.8 \dots 1.2 U_N$	$0.8 \dots 1.2 U_N$
Power consumption AC / DC	50 / 32 mA	21 / 12 mA	47 mA / -	60 mA / -
Typ. input current on command input AC / DC	2.7 / 4.3 mA	11.6 / 9.5 mA	1.7 mA / -	1.9 mA / -
Typ. threshold voltage on command input AC / DC	5.2 / 8.8 V	9.5 / 14 V	42 V / -	80 V / -
Rated frequency	48 ... 62 Hz	48 ... 62 Hz	48 ... 62 Hz	48 ... 62 Hz

### Insulation

Rated test voltage control / main circuit	2 kV rms / 1 min
Rated test voltage open contact	1 kV rms / 1 min
Pollution degree	2
Overvoltage category	III

### General data

Ambient temperature storage	-40 ... 85 °C
Ambient temperature operation	-40 ... 60 °C
Conductor cross section	2.5 mm <sup>2</sup> , 2 x 1.5 mm <sup>2</sup>
Nominal screw torque	0.5 Nm
Module width	fig. 4
Weight	48 g
Protection degree	IP 20
Housing material	PA 66

### Product references

Types	Product reference	12	24	115	230
UC supply	CMD11-E/UC...V	✓	✓		
AC supply	CMD11-E/AC...V			✓	✓

"..." list control circuit voltage to complete product references.  
Other voltages on request. Please contact support@comatreleco.com.



fig. 1. Wiring diagram



fig. 2. DC load limit curve

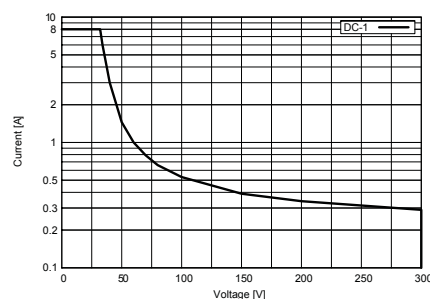


fig. 3. AC voltage endurance

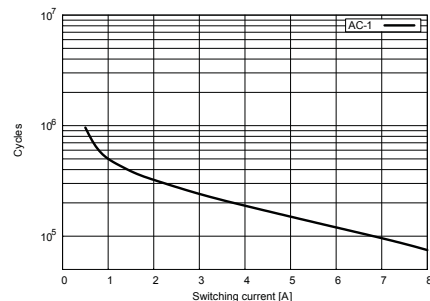
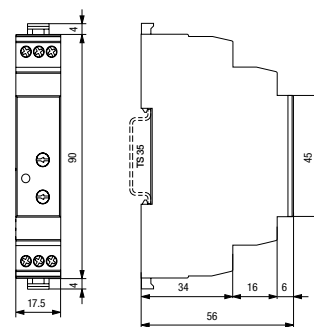


fig. 4. Dimensions (mm)



### Standards and approvals

Standards IEC/EN 60947

Approvals



## 2.1 ON and OFF delay Relays

### AA2, AA2M

Off delay | 24 V UC | 220 ... 240 V AC | 1 CO

#### Time data

Timing functions	A
Timing range	AA2: 0.8 s ... 1.5 min / AA2M: 0.1 min ... 12 min
Timing scale	AA2: 12 s / 1.5 min / AA2M: 1.5 min / 12 min

#### Main circuit

Number of contacts	1 CO
Contact Material	AgNi
Rated voltage	250 V AC
Rated current	10 A
Minimum load	10 mA, 12 V
Inrush current	16 A, 10 ms
Rated load DC	fig. 2
Rated load AC-1	2500 VA
Mechanical endurance (cycles)	$2 \times 10^7$
Electrical endurance at rated load AC-1 (cycles)	fig. 3

#### Control circuit

Nominal voltage	24 V UC	220 ... 240 V AC
Operating voltage range	$0.8 \dots 1.3 U_N$	$0.8 \dots 1.1 U_N$
Power consumption AC / DC	0.84 VA / 0.84 W	2.4 VA / -
Typ. input current on command input AC / DC	25 / 25 mA	5 mA / -
Typ. threshold voltage on command input AC / DC	10 / 10 V	176 V / -
Rated frequency	48 ... 63 Hz	48 ... 63 Hz

#### Insulation

Rated test voltage control / main circuit	2 kV rms / 1 min
Rated test voltage open contact	1 kV rms / 1 min
Pollution degree	2
Overvoltage category	III

#### General data

Ambient temperature storage	-40 ... 85 °C
Ambient temperature operation	-40 ... 60 °C
Conductor cross section	$2.5 \text{ mm}^2$ , $2 \times 1.5 \text{ mm}^2$
Nominal screw torque	0.4 Nm
Module width	fig. 4
Weight	65 g
Protection degree	IP 20
Housing material	PC

#### Product references

Types	Product reference	24	220-240
UC supply	AA2/UC...V	✓	
AC supply	AA2/AC...V		✓
UC supply	AA2M/UC...V	✓	
AC supply	AA2M/AC...V		✓

"..." list control circuit voltage to complete product references.

Other voltages on request. Please contact [support@comatreleco.com](mailto:support@comatreleco.com).

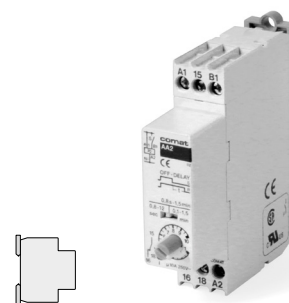


fig. 1. Wiring diagram

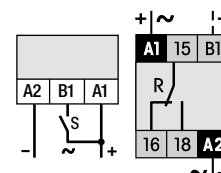


fig. 2. DC load limit curve

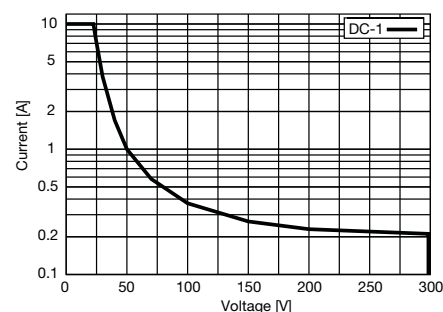


fig. 3. AC voltage endurance

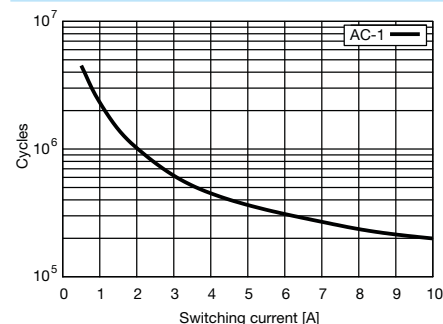
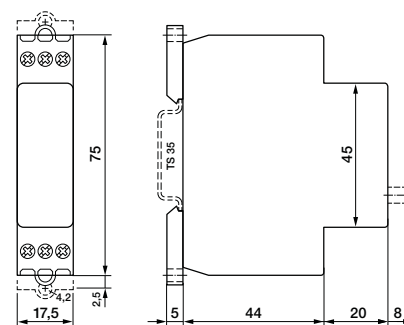


fig. 4. Dimensions (mm)



#### Standards and approvals

Standards IEC/EN 60947

Approvals

## AE2, AE2M

On delay | 24 V UC | 220 ... 240 V AC | 1 CO

### Time data

Timing functions	E
Timing range	AE2: 0.8 s ... 1.5 min / AE2M: 0.1 min ... 12 min
Timing scale	AE2: 12 s / 1.5 min / AE2M: 1.5 min / 12 min

### Main circuit

Number of contacts	1 CO
Contact Material	AgNi
Rated voltage	250 V AC
Rated current	10 A
Minimum load	10 mA, 12 V
Inrush current	16 A, 10 ms
Rated load DC	fig. 2
Rated load AC-1	2500 VA
Mechanical endurance (cycles)	$2 \times 10^7$
Electrical endurance at rated load AC-1 (cycles)	fig. 3

### Control circuit

Nominal voltage	24 V UC	220 ... 240 V AC
Operating voltage range	0.8 ... 1.3 $U_N$	0.8 ... 1.1 $U_N$
Power consumption AC / DC	0.84 VA / 0.84 W	2.4 VA / -
Typ. input current on command input AC / DC	25 / 25 mA	5 mA / -
Typ. threshold voltage on command input AC / DC	10 V / 10 V	176 V / -
Rated frequency	48 ... 63 Hz	48 ... 63 Hz

### Insulation

Rated test voltage control / main circuit	2 kV rms / 1 min
Rated test voltage open contact	1 kV rms / 1 min
Pollution degree	2
Overvoltage category	III

### General data

Ambient temperature storage	-40 ... 85 °C
Ambient temperature operation	-40 ... 60 °C
Conductor cross section	2.5 mm <sup>2</sup> , 2 x 1.5 mm <sup>2</sup>
Nominal screw torque	0.4 Nm
Module width	fig. 4
Weight	65 g
Protection degree	IP 20
Housing material	PC

### Product references

Types	Product reference	24	220-240
UC supply	AE2/UC...V	✓	
AC supply	AE2/AC...V		✓
UC supply	AE2M/UC...V	✓	
AC supply	AE2M/AC...V		✓

"..." list control circuit voltage to complete product references.  
Other voltages on request. Please contact support@comatreleco.com.

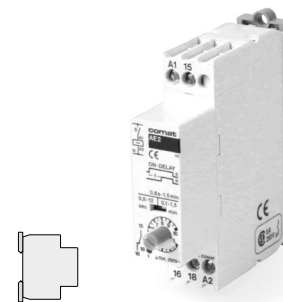


fig. 1. Wiring diagram

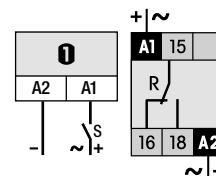


fig. 2. DC load limit curve

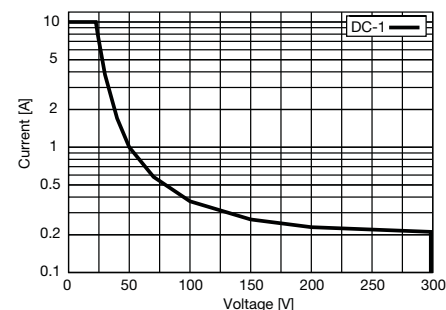


fig. 3. AC voltage endurance

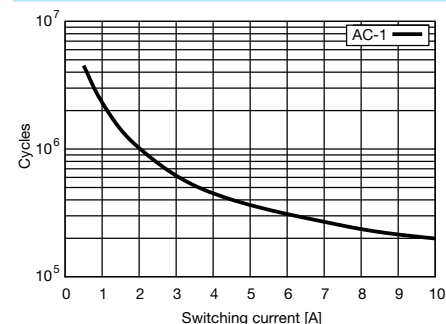
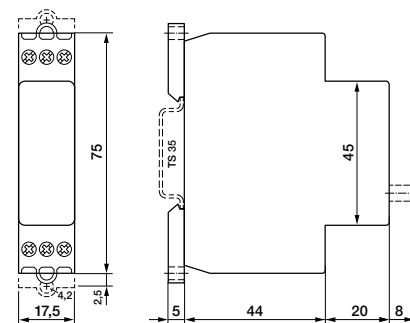


fig. 4. Dimensions (mm)



### Standards and approvals

Standards IEC/EN 60947

Approvals



## 2.2 Multifunction Time Relays

Application	Type	Page
<b>CIM Series</b>		
Multifunction   24 ... 240 V UC   1 CO	CIM1, CIM1R	160
Multifunction   24 ... 240 V UC   1 Triac	CIM12, CIM12R	161
Multifunction   24 ... 240 V UC   1 Mosfet	CIM13, CIM13R	162
Multifunction   24 ... 240 V UC   1 NO, pre-contact	CIM14	163
Multifunction   24 ... 240 V UC   1 CO	CIM2, CIM2R	164
Multifunction   24 ... 240 V UC   1 Triac	CIM22, CIM22R	165
Multifunction   24 ... 240 V UC   1 Mosfet	CIM23, CIM23R	166
Multifunction   24 ... 240 V UC   1 CO	CIM3, CIM3R	167
Multifunction   24 ... 240 V UC   1 Triac	CIM32, CIM32R	168
Multifunction   24 ... 240 V UC   1 Mosfet	CIM33, CIM33R	169
<b>AL Series</b>		
Staircase switch   Auto - ON   220 ... 240 V AC   1 NO	AL1	170
Staircase switch   Auto - ON   24 V UC   220 ... 240 V AC   1 NO, pre-contact	AL3	171
Staircase switch   Auto - ON   Central ON - OFF   220 ... 240 V AC   1 NO, pre-contact	AL4	172
Step switch   Auto - ON   Central ON - OFF   230 V AC   1 NO, pre-contact	AL5	173
<b>AM Series</b>		
Multifunction   24 ... 60 V UC   110 ... 240 V UC   1 CO	AM1	174
Multifunction   24 ... 60 V UC   220 ... 240 V AC   1 CO	AM2	175
Multifunction   24 ... 60 V UC   110 ... 240 V UC   2 CO	AM3	176



Application	Type	Page
<b>CM Series</b>		
Multifunction   24 ... 60 V UC   220 ... 240 V AC   1 NO + 1 CO	CM2	177
Multifunction   12 ... 24 V DC   24 ... 48 V DC, 24 ... 240 V AC   2 CO	CM3	178
<b>CPF Series</b>		
Pulse extension   24 V DC   1 PNP Transistor	CPF11	179
<b>CRV Series</b>		
Multifunction   24 ... 240 V UC   1 CO   External potentiometer	CRV4	180
<b>CSV Series</b>		
Multifunction   12 ... 36 V DC   1 Mosfet   External potentiometer	CSV4	181

## 2.2 Multifunction Time Relays

### CIM1, CIM1R

Multifunction | 24 ... 240 V UC | 1 CO

#### Time data

Timing functions	fig. 1 1: E 2: A, K, N, B1, S, LS 3: B, W
Timing range	50 ms ... 60 h
Timing scale	0.6 s / 6 s / 60 s / 6 min / 60 min / 6 h / 60 h

#### Main circuit

Number of contacts	1 CO
Contact Material	AgNi
Rated voltage	250 V AC
Rated current	16 A
Minimum load	10 mA, 10 V
Inrush current	30 A, 10 ms
Rated load DC	fig. 2
Rated load AC-1	4000 VA
Mechanical endurance (cycles)	$3 \times 10^7$
Electrical endurance at rated load AC-1 (cycles)	fig. 3

#### Control circuit

Nominal voltage	24 ... 240 V UC
Operating voltage range	16.8 ... 250 V
Power consumption AC / DC	1.2 VA / 430 mW
Typ. input current on command input AC / DC	22 / 22 mA
Typ. threshold voltage on command input AC / DC	13 V / 15 V
Rated frequency	16 ... 63 Hz

#### Insulation

Rated test voltage control / main circuit	2.5 kV rms / 1 min
Rated test voltage open contact	1 kV rms / 1 min
Pollution degree	2
Overvoltage category	III

#### General data

Ambient temperature storage	-40 ... 85 °C
Ambient temperature operation	-40 ... 40 °C
Ambient temperature operation derated power	-40 ... 60 °C ( $I_N$ 13 A)
Ambient temperature operation railway version	-40 ... 70 °C
Conductor cross section	2.5 mm <sup>2</sup> , 2 x 1.5 mm <sup>2</sup>
Nominal screw torque	0.4 Nm
Module width	fig. 4
Weight	70 g
Protection degree	IP 20
Housing material	PC

#### Product references

Types	Product reference	24-240
UC supply	CIM1/UC...V	✓
UC supply, Railway version	CIM1R/UC...V	✓

"..." list control circuit voltage to complete product references.

Other voltages on request. Please contact [support@comatreleco.com](mailto:support@comatreleco.com).



**comat**  
**RELECO**



fig. 1. Wiring diagram

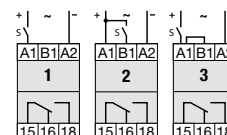


fig. 2. DC load limit curve

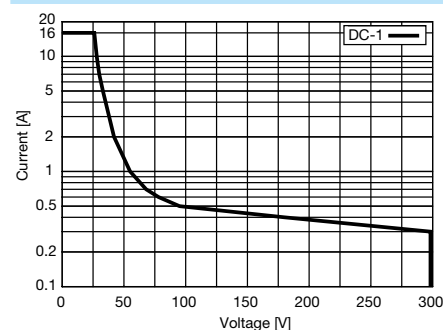


fig. 3. AC voltage endurance

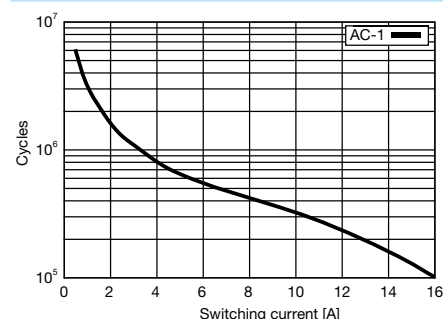
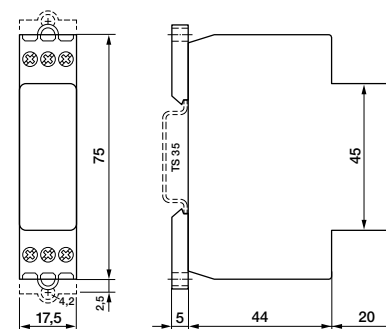


fig. 4. Dimensions (mm)



#### Standards and approvals

Standards IEC/EN 60947, IEC/EN 50155

Approvals





## CIM12, CIM12R

Multifunction | 24 ... 240 V UC | 1 Triac



### Time data

Timing functions	fig. 1 1: E 2: A, K, N, B1, S, LS 3: B, W
Timing range	50 ms ... 60 h
Timing scale	0.6 s / 6 s / 60 s / 6 min / 60 min / 6 h / 60 h

### Main circuit

Number of outputs	1 NO
Output type	⚡ Triac, zero crossing
Rated voltage	250 V AC
Rated current	2 A
Minimum load	50 mA, 12 V
Inrush current	100 A, 10 ms
Rated limit load	78 A <sup>2</sup> s
Typ. leakage current	1 mA
Rated load AC-1	300 VA
Mechanical endurance (cycles)	∞
Electrical endurance at rated load AC-1 (cycles)	∞

### Control circuit

Nominal voltage	24 ... 240 V UC
Operating voltage range	16.8 ... 250 V
Power consumption AC / DC	1.2 VA / 430 mW
Typ. input current on command input AC / DC	22 / 22 mA
Typ. threshold voltage on command input AC / DC	13 V / 15 V
Rated frequency	16 ... 63 Hz

### Insulation

Rated test voltage control / main circuit	2.5 kV rms / 1 min
Rated test voltage open contact	0
Pollution degree	2
Overvoltage category	III

### General data

Ambient temperature storage	-40 ... 85 °C
Ambient temperature operation	-40 ... 40 °C
Ambient temperature operation derated power	-40 ... 60 °C (I <sub>N</sub> 1.2 A)
Ambient temperature operation railway version	-40 ... 70 °C
Conductor cross section	2.5 mm <sup>2</sup> , 2 x 1.5 mm <sup>2</sup>
Nominal screw torque	0.4 Nm
Module width	fig. 2
Weight	70 g
Protection degree	IP 20
Housing material	PC

### Product references

Types	Product reference	24-240
UC supply	CIM12/UC...V	✓
UC supply, Railway version	CIM12R/UC...V	✓

"..." list control circuit voltage to complete product references.

Other voltages on request. Please contact support@comatreleco.com.

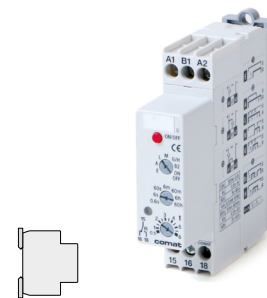


fig. 1. Wiring diagram

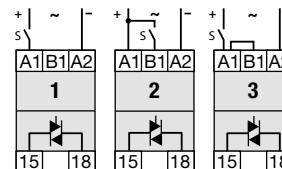
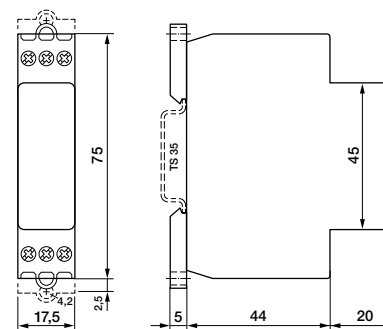


fig. 2. Dimensions (mm)



### Standards and approvals

Standards IEC/EN 60947, IEC/EN 50155

Approvals

## 2.2 Multifunction Time Relays

### CIM13, CIM13R

Multifunction | 24 ... 240 V UC | 1 Mosfet

#### Time data

Timing functions	fig. 1 1: E 2: A, K, N, B1, S, LS 3: B, W
Timing range	50 ms ... 60 h
Timing scale	0.6 s / 6 s / 60 s / 6 min / 60 min / 6 h / 60 h

#### Main circuit

Number of outputs	1NO
Output type	⚡ Mosfet
Rated voltage	24 V DC
Rated current	5 A
Minimum load	1 mA, 1 V
Inrush current	40 A, 10 us
Typ. leakage current	10 μA
Mechanical endurance (cycles)	∞
Electrical endurance at rated load DC-1 (cycles)	∞

#### Control circuit

Nominal voltage	24 ... 240 V UC
Operating voltage range	16.8 ... 250 V
Power consumption AC / DC	1.2 VA / 430 mW
Typ. input current on command input AC / DC	22 / 22 mA
Typ. threshold voltage on command input AC / DC	13 V / 15 V
Rated frequency	16 ... 63 Hz

#### Insulation

Rated test voltage control / main circuit	2.5 kV rms / 1 min
Rated test voltage open contact	0
Pollution degree	2
Overvoltage category	III

#### General data

Ambient temperature storage	-40 ... 85 °C
Ambient temperature operation	-40 ... 40 °C
Ambient temperature operation derated power	-40 ... 60 °C (I <sub>N</sub> 4 A)
Ambient temperature operation railway version	-40 ... 70 °C
Conductor cross section	2.5 mm <sup>2</sup> , 2 x 1.5 mm <sup>2</sup>
Nominal screw torque	0.4 Nm
Module width	fig. 2
Weight	70 g
Protection degree	IP 20
Housing material	PC

#### Product references

Types	Product reference	24-240
UC supply	CIM13/UC...V	✓
UC supply, Railway version	CIM13R/UC...V	✓

"..." list control circuit voltage to complete product references.

Other voltages on request. Please contact support@comatreleco.com.



**comat**  
**RELECO**

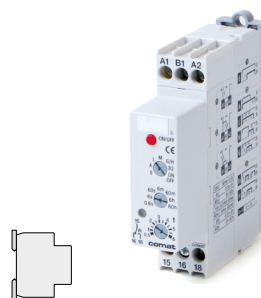


fig. 1. Wiring diagram

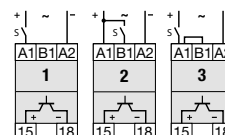
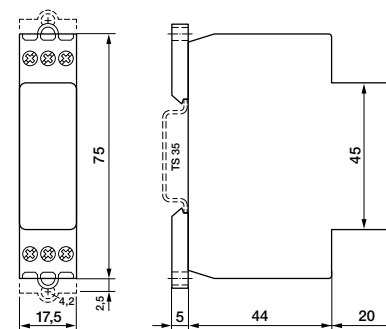


fig. 2. Dimensions (mm)



#### Standards and approvals

Standards IEC/EN 60947, IEC/EN 50155

Approvals

**CIM14**

**Multifunction | 24 ... 240 V UC | 1 NO, pre-contact**

**Time data**

Timing functions	fig. 1 1: E 2: A, K, N, B1, S, LS 3: B, W
Timing range	50 ms ... 60 h
Timing scale	0.6 s / 6 s / 60 s / 6 min / 60 min / 6 h / 60 h

**Main circuit**

Number of contacts	1 NO
Contact Material	⚡ W + AgSnO <sub>2</sub>
Rated voltage	250 V AC
Rated current	16 A
Minimum load	100 mA, 12 V
Inrush current	800 A, 200 us / 165 A, 20 ms
Rated load DC	fig. 2
Rated load AC-1	4000 VA
Mechanical endurance (cycles)	5 x 10 <sup>6</sup>
Electrical endurance at rated load AC-1 (cycles)	fig. 3

**Control circuit**

Nominal voltage	24 ... 240 V UC
Operating voltage range	16.8 ... 250 V
Power consumption AC / DC	1.2 VA / 430 mW
Typ. input current on command input AC / DC	22 / 22 mA
Typ. threshold voltage on command input AC / DC	13 V / 15 V
Rated frequency	16 ... 63 Hz

**Insulation**

Rated test voltage control / main circuit	2.5 kV rms / 1 min
Rated test voltage open contact	1 kV rms / 1 min
Pollution degree	2
Overvoltage category	III

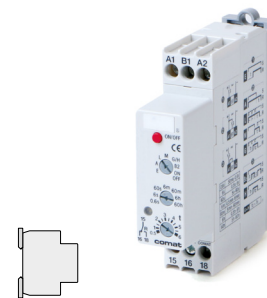
**General data**

Ambient temperature storage	-40 ... 85 °C
Ambient temperature operation	-40 ... 40 °C
Ambient temperature operation derated power	-40 ... 60 °C (I <sub>N</sub> 13 A)
Conductor cross section	2.5 mm <sup>2</sup> , 2 x 1.5 mm <sup>2</sup>
Nominal screw torque	0.4 Nm
Module width	fig. 4
Weight	70 g
Protection degree	IP 20
Housing material	PC

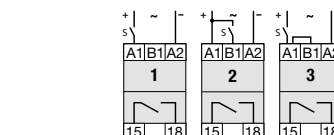
**Product references**

Types	Product reference	24-240
UC supply	CIM14/UC...V	✓

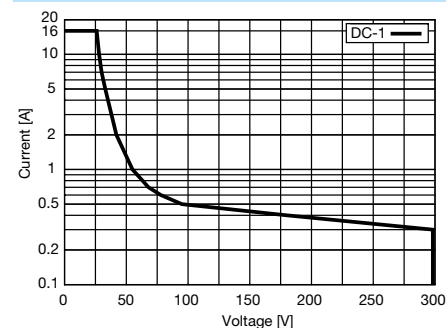
"..." list control circuit voltage to complete product references.  
Other voltages on request. Please contact support@comatreleco.com.



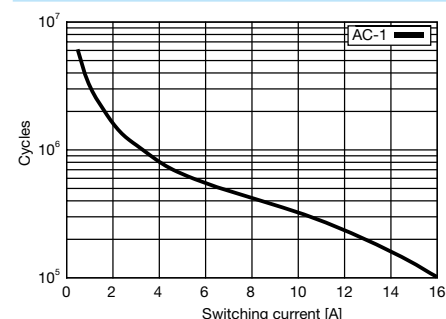
**fig. 1. Wiring diagram**



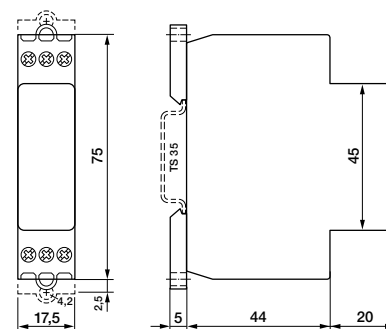
**fig. 2. DC load limit curve**



**fig. 3. AC voltage endurance**



**fig. 4. Dimensions (mm)**



**Standards and approvals**

Standards IEC/EN 60947, IEC/EN 50155

Approvals

# CIM2, CIM2R

Multifunction | 24 ... 240 V UC | 1 CO



### Time data

Timing functions	fig. 1 1: E 2: A, L, M, G 3: B2, H
Timing range	50 ms ... 60 h
Timing scale	0.6 s / 6 s / 60 s / 6 min / 60 min / 6 h / 60 h

### Main circuit

Number of contacts	1 CO
Contact Material	AgNi
Rated voltage	250 V AC
Rated current	16 A
Minimum load	10 mA, 10 V
Inrush current	30 A, 10 ms
Rated load DC	fig. 2
Rated load AC-1	4000 VA
Mechanical endurance (cycles)	$3 \times 10^7$
Electrical endurance at rated load AC-1 (cycles)	fig. 3

### Control circuit

Nominal voltage	24 ... 240 V UC
Operating voltage range	16.8 ... 250 V
Power consumption AC / DC	1.2 VA / 430 mW
Typ. input current on command input AC / DC	22 / 22 mA
Typ. threshold voltage on command input AC / DC	13 V / 15 V
Rated frequency	16 ... 63 Hz

### Insulation

Rated test voltage control / main circuit	2.5 kV rms / 1 min
Rated test voltage open contact	1 kV rms / 1 min
Pollution degree	2
Overvoltage category	III

### General data

Ambient temperature storage	-40 ... 85 °C
Ambient temperature operation	-40 ... 40 °C
Ambient temperature operation derated power	-40 ... 60 °C ( $I_N$ 13 A)
Ambient temperature operation railway version	-40 ... 70 °C
Conductor cross section	2.5 mm <sup>2</sup> , 2 x 1.5 mm <sup>2</sup>
Nominal screw torque	0.4 Nm
Module width	fig. 4
Weight	70 g
Protection degree	IP 20
Housing material	PC

### Product references

Types	Product reference	24-240
UC supply	CIM2/UC...V	✓
UC supply, Railway version	CIM2R/UC...V	✓

"..." list control circuit voltage to complete product references.  
Other voltages on request. Please contact [support@comatreleco.com](mailto:support@comatreleco.com).

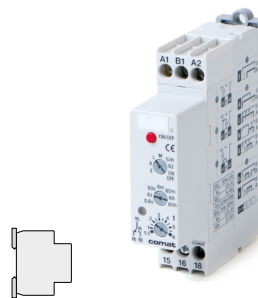


fig. 1. Wiring diagram

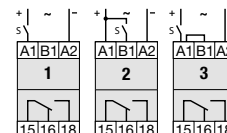


fig. 2. DC load limit curve

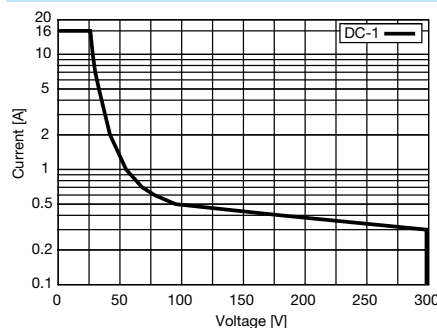


fig. 3. AC voltage endurance

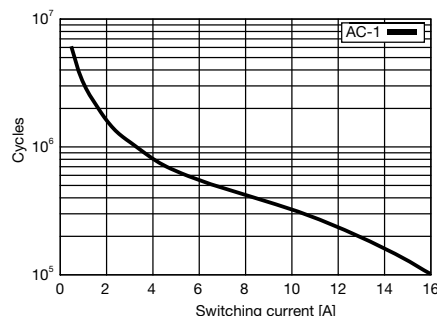
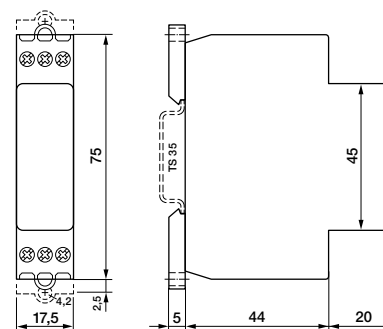


fig. 4. Dimensions (mm)



### Standards and approvals

Standards IEC/EN 60947, IEC/EN 50155

Approvals

## 2.2 Multifunction Time Relays

### CIM22, CIM22R

Multifunction | 24 ... 240 V UC | 1 Triac

#### Time data

Timing functions	fig. 1 1: E 2: A, L, M, G 3: B2, H
Timing range	50 ms ... 60 h
Timing scale	0.6 s / 6 s / 60 s / 6 min / 60 min / 6 h / 60 h

#### Main circuit

Number of outputs	1 NO
Output type	⚡ Triac, zero crossing
Rated voltage	250 V AC
Rated current	2 A
Minimum load	50 mA, 12 V
Inrush current	100 A, 10 ms
Rated limit load	78 A <sup>2</sup> s
Typ. leakage current	1 mA
Rated load AC-1	300 VA
Mechanical endurance (cycles)	∞
Electrical endurance at rated load AC-1 (cycles)	∞

#### Control circuit

Nominal voltage	24 ... 240 V UC
Operating voltage range	16.8 ... 250 V
Power consumption AC / DC	1.2 VA / 430 mW
Typ. input current on command input AC / DC	22 / 22 mA
Typ. threshold voltage on command input AC / DC	13 V / 15 V
Rated frequency	16 ... 63 Hz

#### Insulation

Rated test voltage control / main circuit	2.5 kV rms / 1 min
Rated test voltage open contact	0
Pollution degree	2
Overvoltage category	III

#### General data

Ambient temperature storage	-40 ... 85 °C
Ambient temperature operation	-40 ... 40 °C
Ambient temperature operation derated power	-40 ... 60 °C (I <sub>N</sub> 1.2 A)
Ambient temperature operation railway version	-40 ... 70 °C
Conductor cross section	2.5 mm <sup>2</sup> , 2 x 1.5 mm <sup>2</sup>
Nominal screw torque	0.4 Nm
Module width	fig. 2
Weight	70 g
Protection degree	IP 20
Housing material	PC

#### Product references

Types	Product reference	24-240
UC supply	CIM22/UC...V	✓
UC supply, Railway version	CIM22R/UC...V	✓

"..." list control circuit voltage to complete product references.

Other voltages on request. Please contact [support@comatreleco.com](mailto:support@comatreleco.com).



**comat**  
**RELECO**



fig. 1. Wiring diagram

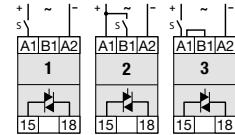
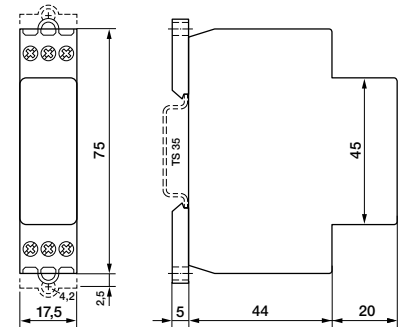


fig. 2. Dimensions (mm)



#### Standards and approvals

Standards IEC/EN 60947, IEC/EN 50155

Approvals

## 2.2 Multifunction Time Relays

### CIM23, CIM23R

Multifunction | 24 ... 240 V UC | 1 Mosfet



**comat**  
**RELECO**

#### Time data

Timing functions	fig. 1 1: E 2: A, L, M, G 3: B2, H
Timing range	50 ms ... 60 h
Timing scale	0.6 s / 6 s / 60 s / 6 min / 60 min / 6 h / 60 h

#### Main circuit

Number of outputs	1 NO
Output type	Mosfet
Rated voltage	24 V DC
Rated current	5 A
Minimum load	1 mA, 1 V
Inrush current	40 A, 10 us
Typ. leakage current	10 µA
Mechanical endurance (cycles)	∞
Electrical endurance at rated load DC-1 (cycles)	∞

#### Control circuit

Nominal voltage	24 ... 240 V UC
Operating voltage range	16.8 ... 250 V
Power consumption AC / DC	1.2 VA / 430 mW
Typ. input current on command input AC / DC	22 / 22 mA
Typ. threshold voltage on command input AC / DC	13 V / 15 V
Rated frequency	16 ... 63 Hz

#### Insulation

Rated test voltage control / main circuit	2.5 kV rms / 1 min
Rated test voltage open contact	0
Pollution degree	2
Overvoltage category	III

#### General data

Ambient temperature storage	-40 ... 85 °C
Ambient temperature operation	-40 ... 40 °C
Ambient temperature operation derated power	-40 ... 60 °C (I <sub>N</sub> 4 A)
Ambient temperature operation railway version	-40 ... 70 °C
Conductor cross section	2.5 mm <sup>2</sup> , 2 x 1.5 mm <sup>2</sup>
Nominal screw torque	0.4 Nm
Module width	fig. 2
Weight	70 g
Protection degree	IP 20
Housing material	PC

#### Product references

Types	Product reference	24-240
UC supply	CIM23/UC...V	✓
UC supply, Railway version	CIM23R/UC...V	✓

"..." list control circuit voltage to complete product references.

Other voltages on request. Please contact support@comatreleco.com.

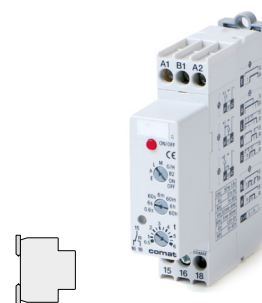


fig. 1. Wiring diagram

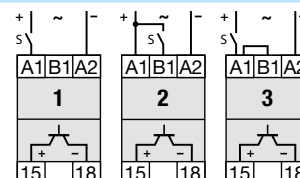
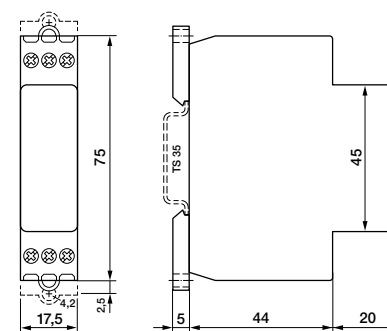


fig. 2. Dimensions (mm)



#### Standards and approvals

Standards IEC/EN 60947, IEC/EN 50155

Approvals

## CIM3, CIM3R

Multifunction | 24 ... 240 V UC | 1 CO



### Time data

Timing functions	fig. 1 2: F, Q, G 3: I, P, H
Timing range	50 ms ... 60 h
Timing scale	0.6 s / 6 s / 60 s / 6 min / 60 min / 6 h / 60 h

### Main circuit

Number of contacts	1 CO
Contact Material	AgNi
Rated voltage	250 V AC
Rated current	16 A
Minimum load	10 mA, 10 V
Inrush current	30 A, 10 ms
Rated load DC	fig. 2
Rated load AC-1	4000 VA
Mechanical endurance (cycles)	$3 \times 10^7$
Electrical endurance at rated load AC-1 (cycles)	fig. 3

### Control circuit

Nominal voltage	24 ... 240 V UC
Operating voltage range	16.8 ... 250 V
Power consumption AC / DC	1.2 VA / 430 mW
Typ. input current on command input AC / DC	22 / 22 mA
Typ. threshold voltage on command input AC / DC	13 V / 15 V
Rated frequency	16 ... 63 Hz

### Insulation

Rated test voltage control / main circuit	2.5 kV rms / 1 min
Rated test voltage open contact	0
Pollution degree	2
Overtoltage category	III

### General data

Ambient temperature storage	-40 ... 85 °C
Ambient temperature operation	-40 ... 40 °C
Ambient temperature operation derated power	-40 ... 60 °C ( $I_N$ 13 A)
Ambient temperature operation railway version	-40 ... 70 °C
Conductor cross section	2.5 mm <sup>2</sup> , 2 x 1.5 mm <sup>2</sup>
Nominal screw torque	0.4 Nm
Module width	fig. 4
Weight	70 g
Protection degree	IP 20
Housing material	PC

### Product references

Types	Product reference	24-240
UC supply	CIM3/UC...V	✓
UC supply, Railway version	CIM3R/UC...V	✓

"..." list control circuit voltage to complete product references.  
Other voltages on request. Please contact [support@comatreleco.com](mailto:support@comatreleco.com).



fig. 1. Wiring diagram

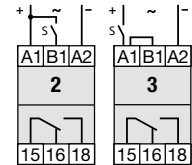


fig. 2. DC load limit curve

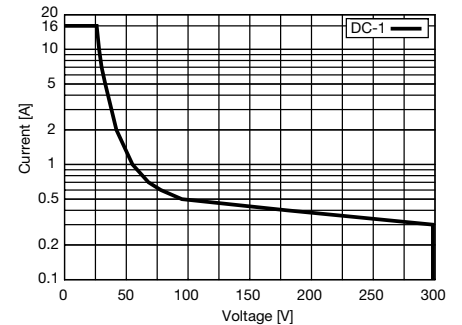


fig. 3. AC voltage endurance

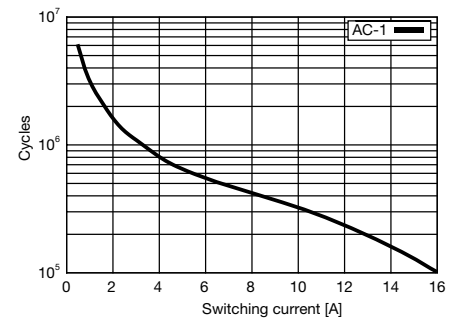
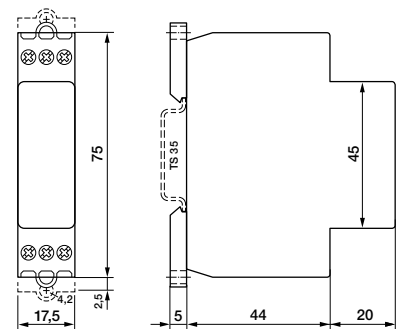


fig. 4. Dimensions (mm)



### Standards and approvals

Standards IEC/EN 60947, IEC/EN 50155

Approvals

## 2.2 Multifunction Time Relays

### CIM32, CIM32R

Multifunction | 24 ... 240 V UC | 1 Triac



**comat**  
**RELECO**

#### Time data

Timing functions	fig. 1 2: F, Q, G 3: I, P, H
Timing range	50 ms ... 60 h
Timing scale	0.6 s / 6 s / 60 s / 6 min / 60 min / 6 h / 60 h

#### Main circuit

Number of outputs	1NO
Output type	⚡ Triac, zero crossing
Rated voltage	250 V AC
Rated current	2 A
Minimum load	50 mA, 12 V
Inrush current	100 A, 10 ms
Rated limit load	78 A <sup>2</sup> s
Typ. leakage current	1 mA
Rated load AC-1	300 VA
Mechanical endurance (cycles)	∞
Electrical endurance at rated load AC-1 (cycles)	∞

#### Control circuit

Nominal voltage	24 ... 240 V UC
Operating voltage range	16.8 ... 250 V
Power consumption AC / DC	1.2 VA / 430 mW
Typ. input current on command input AC / DC	22 / 22 mA
Typ. threshold voltage on command input AC / DC	13 V / 15 V
Rated frequency	16 ... 63 Hz

#### Insulation

Rated test voltage control / main circuit	2.5 kV rms / 1 min
Rated test voltage open contact	0
Pollution degree	2
Overvoltage category	III

#### General data

Ambient temperature storage	-40 ... 85 °C
Ambient temperature operation	-40 ... 40 °C
Ambient temperature operation derated power	-40 ... 60 °C (I <sub>N</sub> 1.2 A)
Ambient temperature operation railway version	-40 ... 70 °C
Conductor cross section	2.5 mm <sup>2</sup> , 2 x 1.5 mm <sup>2</sup>
Nominal screw torque	0.4 Nm
Module width	fig. 2
Weight	70 g
Protection degree	IP 20
Housing material	PC

#### Product references

Types	Product reference	24-240
UC supply	CIM32/UC...V	✓
UC supply, Railway version	CIM32R/UC...V	✓

"..." list control circuit voltage to complete product references.

Other voltages on request. Please contact [support@comatreleco.com](mailto:support@comatreleco.com).

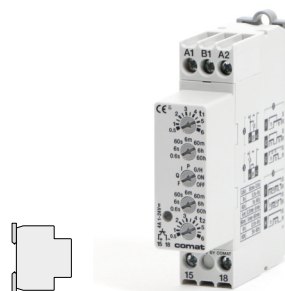


fig. 1. Wiring diagram

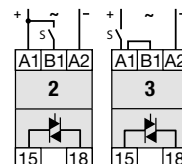
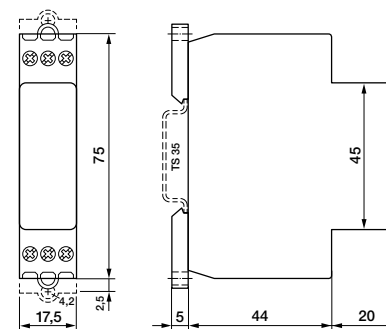


fig. 2. Dimensions (mm)



#### Standards and approvals

Standards IEC/EN 60947

Approvals



## CIM33, CIM33R

Multifunction | 24 ... 240 V UC | 1 Mosfet



### Time data

Timing functions	fig. 1 2: F, Q, G 3: I, P, H
Timing range	50 ms ... 60 h
Timing scale	0.6 s / 6 s / 60 s / 6 min / 60 min / 6 h / 60 h

### Main circuit

Number of outputs	1 NO
Output type	Mosfet
Rated voltage	24 V DC
Rated current	5 A
Minimum load	1 mA, 1 V
Inrush current	40 A, 10 us
Typ. leakage current	10 µA
Mechanical endurance (cycles)	∞
Electrical endurance at rated load DC-1 (cycles)	∞

### Control circuit

Nominal voltage	24 ... 240 V UC
Operating voltage range	16.8 ... 250 V
Power consumption AC / DC	1.2 VA / 430 mW
Typ. input current on command input AC / DC	22 / 22 mA
Typ. threshold voltage on command input AC / DC	13 V / 15 V
Rated frequency	16 ... 63 Hz

### Insulation

Rated test voltage control / main circuit	2.5 kV rms / 1 min
Rated test voltage open contact	0
Pollution degree	2
Overvoltage category	III

### General data

Ambient temperature storage	-40 ... 85 °C
Ambient temperature operation	-40 ... 40 °C
Ambient temperature operation derated power	-40 ... 60 °C (I <sub>N</sub> 4 A)
Ambient temperature operation railway version	-40 ... 70 °C
Conductor cross section	2.5 mm <sup>2</sup> , 2 x 1.5 mm <sup>2</sup>
Nominal screw torque	0.4 Nm
Module width	fig. 2
Weight	70 g
Protection degree	IP 20
Housing material	PC

### Product references

Types	Product reference	24-240
UC supply	CIM33/UC...V	✓
UC supply, Railway version	CIM33R/UC...V	✓

"..." list control circuit voltage to complete product references.

Other voltages on request. Please contact support@comatreleco.com.

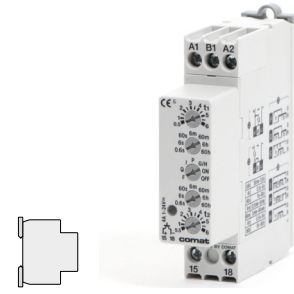


fig. 1. Wiring diagram

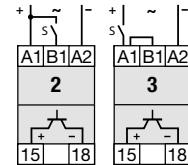
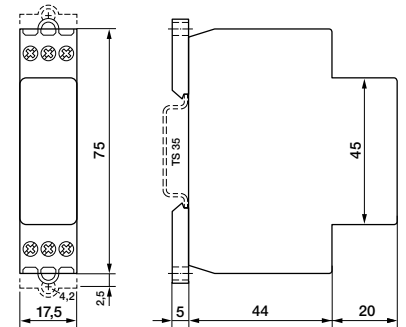


fig. 2. Dimensions (mm)



### Standards and approvals

Standards IEC/EN 60947

Approvals

**AL1**

**Staircase switch | Auto - ON | 220 ... 240 V AC | 1 NO**

**Time data**

Timing functions	L
Timing range	30 s ... 10 min

**Main circuit**

Number of contacts	1 NO
Contact Material	⚡ AgNi
Rated voltage	250 V
Rated current	10 A
Minimum load	10 mA, 12 V
Inrush current	16 A, 10 ms
Rated load DC	fig. 2
Rated load AC-1	2500 VA
Mechanical endurance (cycles)	$2 \times 10^7$
Electrical endurance at rated load AC-1 (cycles)	fig. 3

**Control circuit**

Nominal voltage	220 ... 240 V AC
Operating voltage range	187 ... 265 V
Power consumption AC / DC	2.5 VA
Typ. input current on command input AC / DC	45 mA / -
Typ. threshold voltage on command input AC / DC	$0.7 U_N$
Rated frequency	48 ... 62 Hz

**Insulation**

Rated test voltage control / main circuit	2.5 kV rms / 1 min
Rated test voltage open contact	2.5 kV rms / 1 min
Pollution degree	2
Overtoltage category	III

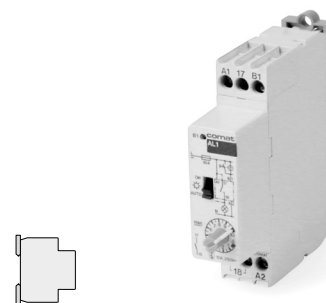
**General data**

Ambient temperature storage	-40 ... 85 °C
Ambient temperature operation	-40 ... 40 °C
Conductor cross section	$2.5 \text{ mm}^2$ , $2 \times 1.5 \text{ mm}^2$
Nominal screw torque	0.4 Nm
Module width	fig. 4
Weight	71 g
Protection degree	IP 20
Housing material	PC

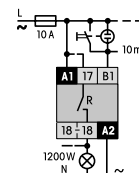
**Product references**

Types	Product reference	220-240
AC supply	AL1/AC...V	✓

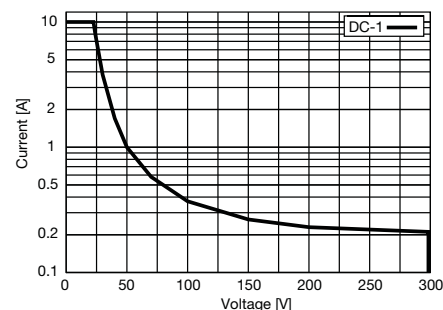
"..." list control circuit voltage to complete product references.  
Other voltages on request. Please contact [support@comatreleco.com](mailto:support@comatreleco.com).



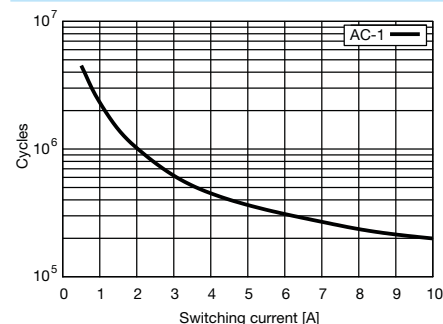
**fig. 1. Wiring diagram**



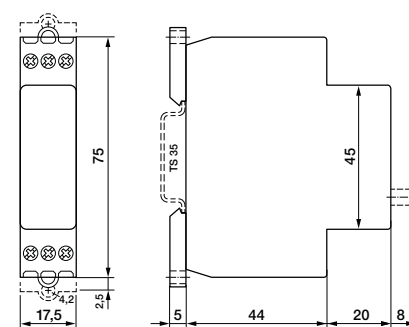
**fig. 2. DC load limit curve**



**fig. 3. AC voltage endurance**



**fig. 4. Dimensions (mm)**



**Standards and approvals**

Standards IEC/EN 60947

Approvals

**AL3**

**Staircase switch | Auto - ON | 24 V UC | 220 ... 240 V AC | 1 NO, pre-contact**

**Time data**

Timing functions	L, LS, S
Timing range	30 s - 60 min
Timing scale	6 min / 60 min

**Main circuit**

Number of contacts	1 NO
Contact Material	W + AgSnO <sub>2</sub>
Rated voltage	250 V
Rated current	10 A
Minimum load	10 mA, 12 V
Inrush current	600 A, 2.5 ms / 120 A, 20 ms
Rated load DC	210 W, 30 V
Rated load AC-1	2500 VA
Mechanical endurance (cycles)	5 x 10 <sup>6</sup>
Electrical endurance at rated load AC-1 (cycles)	5 x 10 <sup>3</sup>

**Control circuit**

Nominal voltage	24 V UC	220 ... 240 V AC
Operating voltage range	19.2 ... 30 V	187 ... 265 V
Power consumption AC / DC	2.5 VA / 2.5 W	2.5 VA / 2.5 W
Typ. input current on command input AC / DC	500 mA	120 mA
Typ. threshold voltage on command input AC / DC	18 V	175 V
Rated frequency	48 ... 63 Hz	48 ... 63 Hz

**Insulation**

Rated test voltage control / main circuit	2.5 kV rms / 1 min
Rated test voltage open contact	2.5 kV rms / 1 min
Pollution degree	2
Overvoltage category	III

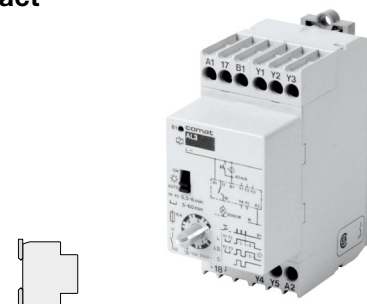
**General data**

Ambient temperature storage	-40 ... 85 °C
Ambient temperature operation	-25 ... 60 °C
Conductor cross section	2.5 mm <sup>2</sup> , 2 x 1.5 mm <sup>2</sup>
Nominal screw torque	0.4 Nm
Module width	fig. 4
Weight	98 g
Protection degree	IP 20
Housing material	PC

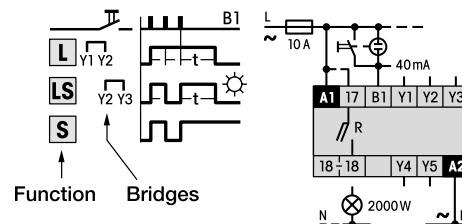
**Product references**

Types	Product reference	24	220-240
UC supply	AL3/UC...V	✓	
AC supply	AL3/AC...V		✓

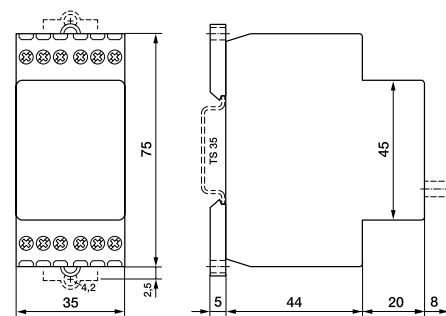
"..." list control circuit voltage to complete product references.  
Other voltages on request. Please contact support@comatreleco.com.



**fig. 1. Wiring diagram**



**fig. 2. Dimensions (mm)**



**Standards and approvals**

Standards IEC/EN 60947

Approvals

## AL4

Staircase switch | Auto - ON | Central ON - OFF | 220 ... 240 V AC | 1 NO, pre-contact

## Time data

Timing functions	fig. 1 L, LS, S
Timing range	30 s - 60 min
Timing scale	6 min / 60 min

## Main circuit

Number of contacts	1 NO
Contact Material	W + AgSnO <sub>2</sub>
Rated voltage	250 V
Rated current	10 A
Minimum load	10 mA, 12 V
Inrush current	600 A, 2.5 ms / 120 A, 20 ms
Rated load DC	210 W, 30 V
Rated load AC-1	2500 VA
Mechanical endurance (cycles)	5 x 10 <sup>6</sup>
Electrical endurance at rated load AC-1 (cycles)	5 x 10 <sup>3</sup>

## Control circuit

Nominal voltage	220 ... 240 V AC
Operating voltage range	187 ... 265 V
Power consumption AC / DC	2.5 VA
Typ. input current on command input AC / DC	120 mA
Typ. threshold voltage on command input AC / DC	175 V
Rated frequency	48 ... 62 Hz

## Insulation

Rated test voltage control / main circuit	2.5 kV rms / 1 min
Rated test voltage open contact	2.5 kV rms / 1 min
Pollution degree	2
Overtoltage category	III

## General data

Ambient temperature storage	-40 ... 85 °C
Ambient temperature operation	-25 ... 60 °C
Conductor cross section	2.5 mm <sup>2</sup> , 2 x 1.5 mm <sup>2</sup>
Nominal screw torque	0.4 Nm
Module width	fig. 4
Weight	98 g
Protection degree	IP 20
Housing material	PC

## Product references

Types	Product reference	220-240
UC supply	AL4/UC...V	✓
AC supply	AL4/AC...V	

"..." list control circuit voltage to complete product references.

Other voltages on request. Please contact [support@comatreleco.com](mailto:support@comatreleco.com).

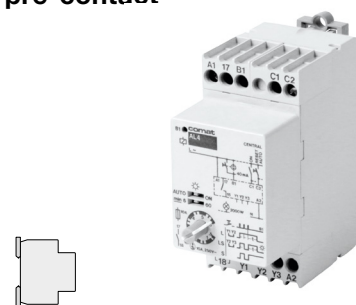


fig. 1. Wiring diagram

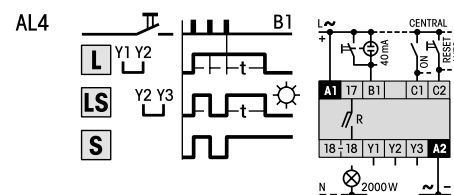
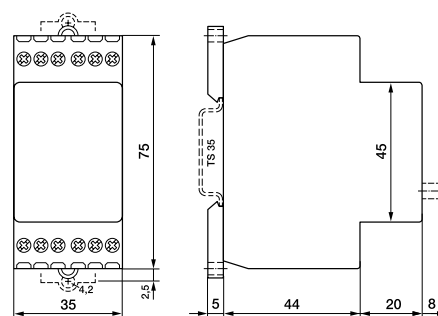


fig. 2. Dimensions (mm)



## Standards and approvals

Standards IEC/EN 60947

Approvals

**AL5**

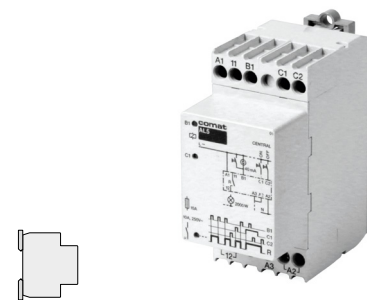
**Step switch | Auto - ON | Central ON - OFF | 230 V AC | 1 NO, pre-contact**

<b>Time data</b>	
Timing functions	S
<b>Main circuit</b>	
Number of contacts	1 NO
Contact Material	W + AgSnO <sub>2</sub>
Rated voltage	250 V
Rated current	10 A
Minimum load	10 mA, 12 V
Inrush current	600 A, 2.5 ms / 120 A, 20 ms
Rated load DC	210 W, 30 V
Rated load AC-1	2500 VA
Mechanical endurance (cycles)	5 x 10 <sup>6</sup>
Electrical endurance at rated load AC-1 (cycles)	5 x 10 <sup>3</sup>
<b>Control circuit</b>	
Nominal voltage	230 V AC
Operating voltage range	187 ... 265 V
Power consumption AC / DC	2.5 VA
Typ. input current on command input AC / DC	120 mA
Typ. threshold voltage on command input AC / DC	165 V
Rated frequency	48 ... 62 Hz
<b>Insulation</b>	
Rated test voltage control / main circuit	2.5 kV rms / 1 min
Rated test voltage open contact	2.5 kV rms / 1 min
Pollution degree	2
Overvoltage category	III
<b>General data</b>	
Ambient temperature storage	-40 ... 85 °C
Ambient temperature operation	-25 ... 60 °C
Conductor cross section	2.5 mm <sup>2</sup> , 2 x 1.5 mm <sup>2</sup>
Nominal screw torque	0.4 Nm
Module width	fig. 4
Weight	98 g
Protection degree	IP 20
Housing material	PC

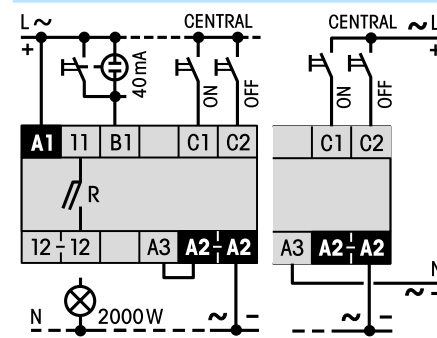
**Product references**

Types	Product reference	230
AC supply	AL5/AC...V	✓

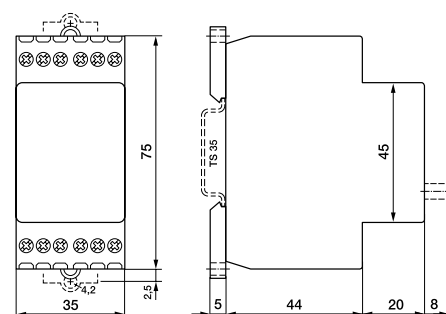
"..." list control circuit voltage to complete product references.  
Other voltages on request. Please contact support@comatreleco.com.



**fig. 1. Wiring diagram**



**fig. 2. Dimensions (mm)**



**Standards and approvals**

Standards IEC/EN 60947

Approvals

# AM1

Multifunction | 24 ... 60 V UC | 110 ... 240 V UC | 1 CO



### Time data

Timing functions	E, W, B, B2
Timing range	0.5 s ... 60 min
Timing scale	6 min / 60 min

### Main circuit

Number of contacts	1 CO
Contact Material	AgNi
Rated voltage	250 V
Rated current	10 A
Minimum load	10 mA, 12 V
Inrush current	16 A, 10 ms
Rated load DC	fig. 2
Rated load AC-1	2500 VA
Mechanical endurance (cycles)	$2 \times 10^7$
Electrical endurance at rated load AC-1 (cycles)	fig. 3

### Control circuit

Nominal voltage	24 ... 60 V UC	220 ... 240 V AC
Operating voltage range	20 - 75 V	180 - 265 V
Power consumption AC / DC	1.5 VA / 1.5 W	1.5 VA / 1.5 W
Typ. input current on command input AC / DC	40 / 40 mA	15 / 15 mA
Typ. threshold voltage on command input AC / DC	18 V / 18 V	170 V / 170 V
Rated frequency	40 ... 60 Hz	40 ... 60 Hz

### Insulation

Rated test voltage control / main circuit	2 kV rms / 1 min
Rated test voltage open contact	1 kV rms / 1 min
Pollution degree	2
Overvoltage category	III

### General data

Ambient temperature storage	-40 ... 85 °C
Ambient temperature operation	-40 ... 60 °C
Conductor cross section	2.5 mm <sup>2</sup> , 2 x 1.5 mm <sup>2</sup>
Nominal screw torque	0.4 Nm
Module width	fig. 4
Weight	70 g
Protection degree	IP 20
Housing material	PC

### Product references

Types	Product reference	24-60	220-240
UC supply	AM1/UC...V	✓	✓

"..." list control circuit voltage to complete product references.  
Other voltages on request. Please contact [support@comatreleco.com](mailto:support@comatreleco.com).

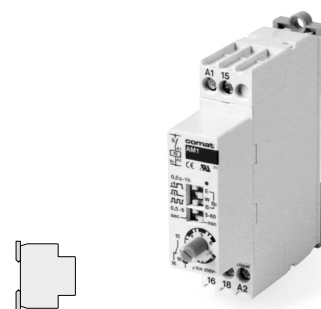


fig. 1. Wiring diagram

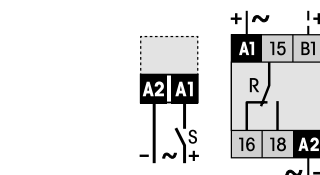


fig. 2. DC load limit curve

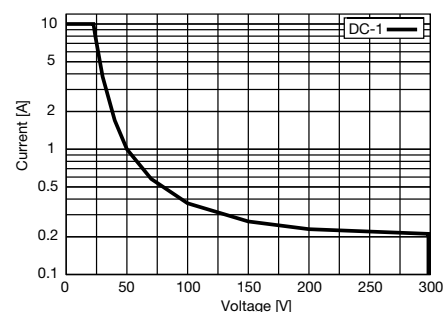


fig. 3. AC voltage endurance

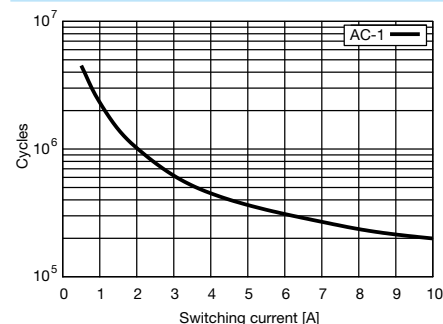
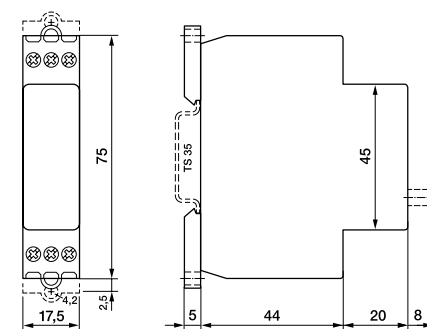


fig. 4. Dimensions (mm)



### Standards and approvals

Standards IEC/EN 60947

Approvals

**AM2**

**Multifunction | 24 ... 60 V UC | 220 ... 240 V AC | 1 CO**

**Time data**

Timing functions	fig. 1 1: E 2: A, K 3: W
Timing range	0.5 s ... 60 min
Timing scale	6 min / 60 min

**Main circuit**

Number of contacts	1 CO
Contact Material	AgNi
Rated voltage	250 V
Rated current	10 A
Minimum load	10 mA, 12 V
Inrush current	16 A, 10 ms
Rated load DC	fig. 2
Rated load AC-1	2500 VA
Mechanical endurance (cycles)	$2 \times 10^7$
Electrical endurance at rated load AC-1 (cycles)	fig. 3

**Control circuit**

Nominal voltage	24 ... 60 V UC	220 ... 240 V AC
Operating voltage range	20 - 75 V	180 - 265 V
Power consumption AC / DC	1.5 VA / 1.5 W	1.5 VA / 1.5 W
Typ. input current on command input AC / DC	40 / 40 mA	15 / 15 mA
Typ. threshold voltage on command input AC / DC	18 V / 18 V	170 V / 170 V
Rated frequency	40 ... 60 Hz	40 ... 60 Hz

**Insulation**

Rated test voltage control / main circuit	2 kV rms / 1 min
Rated test voltage open contact	1 kV rms / 1 min
Pollution degree	2
Overvoltage category	III

**General data**

Ambient temperature storage	-40 ... 85 °C
Ambient temperature operation	-40 ... 60 °C
Conductor cross section	2.5 mm <sup>2</sup> , 2 x 1.5 mm <sup>2</sup>
Nominal screw torque	0.4 Nm
Module width	fig. 4
Weight	70 g
Protection degree	IP 20
Housing material	PC

**Product references**

Types	Product reference	24-60	220-240
UC supply	AM2/UC...V	✓	
AC supply	AM2/AC...V		✓

"..." list control circuit voltage to complete product references.  
Other voltages on request. Please contact support@comatreleco.com.

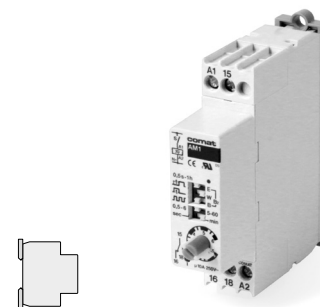


fig. 1. Wiring diagram

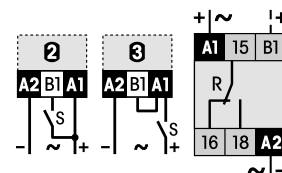


fig. 2. DC load limit curve

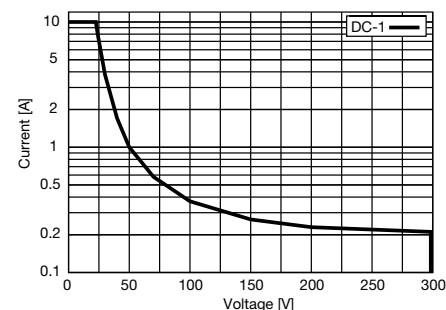


fig. 3. AC voltage endurance

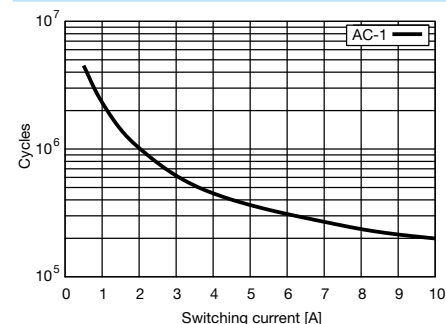
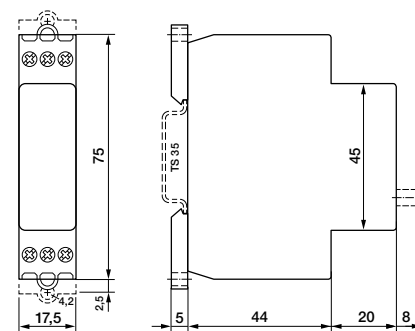


fig. 4. Dimensions (mm)



**Standards and approvals**

Standards IEC/EN 60947

Approvals

**AM3**

**Multifunction | 24 ... 60 V UC | 110 ... 240 V UC | 2 CO**



**Time data**

Timing functions	fig. 1 1: E 2: A, K 3: W
Timing range	0.5 s ... 60 min
Timing scale	6 min / 60 min

**Main circuit**

Number of contacts	2 CO
Contact Material	AgNi
Rated voltage	250 V
Rated current	10 A (total current 12 A)
Minimum load	10 mA, 12 V
Inrush current	16 A, 10 ms
Rated load DC	fig. 2
Rated load AC-1	2500 VA
Mechanical endurance (cycles)	2 x 10 <sup>7</sup>
Electrical endurance at rated load AC-1 (cycles)	fig. 3

**Control circuit**

Nominal voltage	24 ... 60 V UC	220 ... 240 V AC
Operating voltage range	19 ... 75 V	195 ... 265 V
Power consumption AC / DC	1.8 VA / 1.8 W	1.8 VA / 1.8 W
Typ. input current on command input AC / DC	50 / 50 mA	15 / 15 mA
Typ. threshold voltage on command input AC / DC	19 V / 19 V	187 V / 187 V
Rated frequency	40 ... 400 Hz	40 ... 60 Hz

**Insulation**

Rated test voltage control / main circuit	2 kV rms / 1 min
Rated test voltage main / main circuit	2 kV rms / 1 min
Rated test voltage open contact	1 kV rms / 1 min
Pollution degree	2
Overvoltage category	III

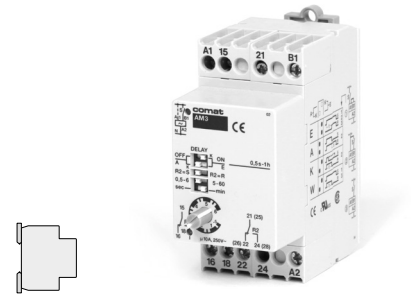
**General data**

Ambient temperature storage	-40 ... 85 °C
Ambient temperature operation	-40 ... 50 °C
Conductor cross section	2.5 mm <sup>2</sup> , 2 x 1.5 mm <sup>2</sup>
Nominal screw torque	0.4 Nm
Module width	fig. 4
Weight	110 g
Protection degree	IP 20
Housing material	PC

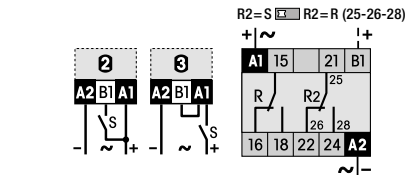
**Product references**

Types	Product reference	24-60	220-240
UC supply	AM3/UC...V	✓	
AC supply	AM3/AC...V		✓

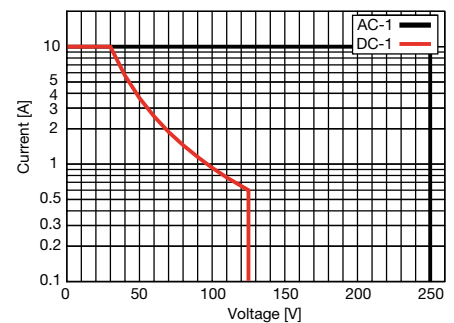
"..." list control circuit voltage to complete product references.  
Other voltages on request. Please contact support@comatreleco.com.



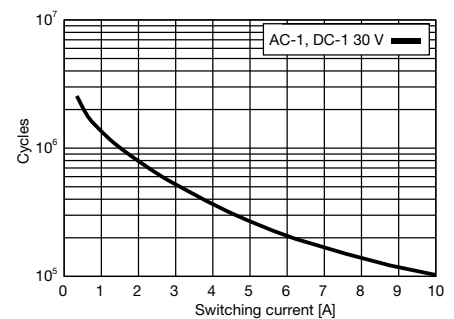
**fig. 1. Wiring diagram**



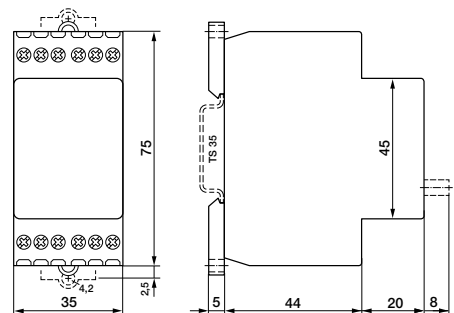
**fig. 2. DC load limit curve**



**fig. 3. AC voltage endurance**



**fig. 4. Dimensions (mm)**



**Standards and approvals**

Standards IEC/EN 60947





## 2.2 Multifunction Time Relays

### CM2

**Multifunction | 24 ... 60 V UC | 220 ... 240 V AC | 1 NO + 1 CO**

#### Time data

Timing functions	fig. 1 2: E, A, K 3: E, W
Timing range	0.3 s ... 12 h
Timing scale	3 s / 12 s / 1.5 min / 12 min / 1.5 h / 12 h

#### Main circuit

Number of contacts	1 NO + 1 CO
Contact Material	AgNi
Rated voltage	250 V
Rated current	6 A
Minimum load	10 mA, 12 V
Inrush current	10 A, 10 ms
Rated load DC	100 W, 24 V
Rated load AC-1	1500 VA
Mechanical endurance (cycles)	1 x 10 <sup>7</sup>
Electrical endurance at rated load AC-1 (cycles)	fig. 3
Electrical endurance at rated load DC-1 (cycles)	1 x 10 <sup>5</sup>

#### Control circuit

Nominal voltage	24 ... 60 V UC	220 ... 240 V AC
Operating voltage range	19 ... 75 V	90 ... 265 V
Power consumption AC / DC	6 VA / 4.8 W	6 VA / 4.8 W
Typ. input current on command input AC / DC	10 / 20 mA	10 / 20 mA
Typ. threshold voltage on command input AC / DC	18 V / 18 V	70 V / 85 V
Rated frequency	40 ... 60 Hz	40 ... 60 Hz

#### Insulation

Rated test voltage control / main circuit	2 kV rms / 1 min
Rated test voltage open contact	1 kV rms / 1 min
Pollution degree	2
Oversvoltage category	III

#### General data

Ambient temperature storage	-40 ... 85 °C
Ambient temperature operation	-40 ... 50 °C
Conductor cross section	2.5 mm <sup>2</sup> , 2 x 1.5 mm <sup>2</sup>
Nominal screw torque	0.4 Nm
Module width	fig. 4
Weight	139 g
Protection degree	IP 20
Housing material	PC

#### Product references

Types	Product reference	24-60	220-240
UC supply	CM2/UC...V	✓	
AC supply	CM2/AC...V		✓

"..." list control circuit voltage to complete product references.

Other voltages on request. Please contact [support@comatreleco.com](mailto:support@comatreleco.com).

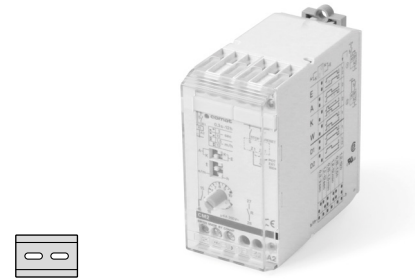


fig. 1. Wiring diagram

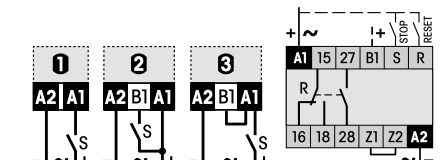
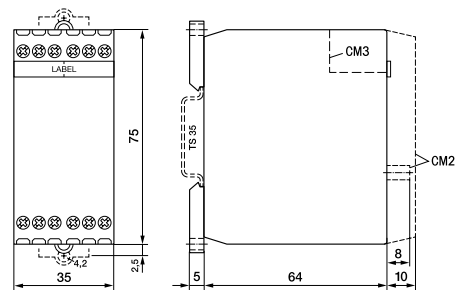


fig. 2. Dimensions (mm)



#### Standards and approvals

Standards IEC/EN 60947

Approvals

# CM3

Multifunction | 12 ... 24 V DC | 24 ... 48 V DC, 24 ... 240 V AC | 2 CO



### Time data

Timing functions	fig. 1 1: E 2: A, K, N, B1 3: B, W
Timing range	50 ms ... 60 h
Timing scale	0.6 s / 6 s / 60 s / 6 min / 60 min / 6 h / 60 h

### Main circuit

Number of contacts	2 CO
Contact Material	AgNi
Rated voltage	250 V
Rated current	5 A
Minimum load	10 mA, 10 V
Inrush current	10 A, 10 ms
Rated load DC	fig. 2
Rated load AC-1	1250 VA
Mechanical endurance (cycles)	15 x 10 <sup>6</sup>
Electrical endurance at rated load AC-1 (cycles)	fig. 3

### Control circuit

Nominal voltage	12 ... 24 V DC	24 ... 48 V DC / 24 ... 240 V AC
Operating voltage range	9.6 ... 28.8 V	19 ... 60 V / 19 ... 250 V
Power consumption AC / DC	- / 1.2 W	15 VA / 1.2 W
Typ. input current on command input AC / DC	10 / 20 mA	10 / 20 mA
Typ. threshold voltage on command input AC / DC	5.8 ... 6.5 V	11 ... 15 V / 13 ... 18 V
Rated frequency	45 ... 63 Hz	45 ... 63 Hz

### Insulation

Rated test voltage control / main circuit	2.5 kV rms / 1 min
Rated test voltage main / main circuit	2.5 kV rms / 1 min
Rated test voltage open contact	1 kV rms / 1 min
Pollution degree	2
Overvoltage category	III

### General data

Ambient temperature storage	-40 ... 85 °C
Ambient temperature operation	-25 ... 60 °C
Conductor cross section	2.5 mm <sup>2</sup> , 2 x 1.5 mm <sup>2</sup>
Nominal screw torque	0.4 Nm
Module width	fig. 4
Weight	72 g
Protection degree	IP 20
Housing material	PC

### Product references

Types	Product reference	12-24	24-48 / 24-240
DC supply	CM3/DC...V	✓	
UC supply	CM3/DC...V/AC...V		✓

"..." list control circuit voltage to complete product references.  
Other voltages on request. Please contact support@comatreleco.com.



fig. 1. Wiring diagram

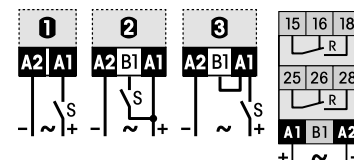


fig. 2. DC load limit curve

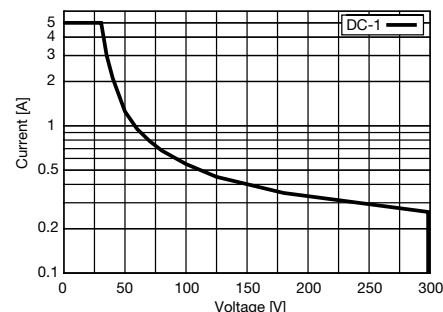


fig. 3. AC voltage endurance

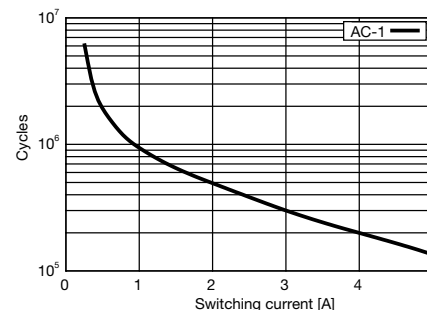
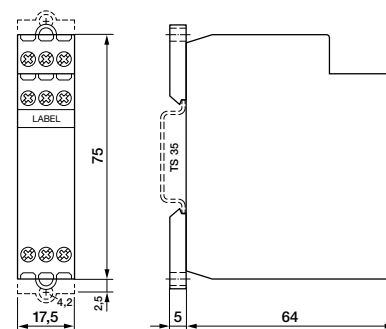


fig. 4. Dimensions (mm)



### Standards and approvals

Standards IEC/EN 60947

Approvals CE EAC cULus

## 2.2 Multifunction Time Relays

### CPF11

#### Pulse extension | 24 V DC | 1 PNP Transistor

##### Time data

Timing functions	A, K, L
Timing range	5 ... 600 ms
Timing scale	60 ms / 600 ms

##### Main circuit

Number of outputs	1 NO
Output type	⚡ PNP Transistor
Output voltage range	10 ... 32 V (Potential of +)
Rated current	0.8 A
Inrush current	2 A, 5 s
Typ. leakage current	1 µA
Mechanical endurance (cycles)	∞
Electrical endurance at rated load DC-1 (cycles)	∞

##### Control circuit

Nominal voltage	24 V DC
Operating voltage range	10 ... 32 V
Power consumption AC / DC	- / 0.4 W
Typ. threshold voltage on command input AC / DC	- / E1: 10 V, E2: 15 V

##### Insulation

Pollution degree	2
Overvoltage category	III

##### General data

Ambient temperature storage	-40 ... 85 °C
Ambient temperature operation	-25 ... 50 °C
Ambient temperature operation derated power	-25 ... 60 °C (I <sub>N</sub> 0.7 A)
Conductor cross section	2.5 mm <sup>2</sup> , 2 x 1.5 mm <sup>2</sup>
Nominal screw torque	0.4 Nm
Module width	fig. 4
Weight	60 g
Protection degree	IP 20
Housing material	PC

##### Product references

Types	Product reference	24
DC supply	CPF11/DC...V	✓

"..." list control circuit voltage to complete product references.

Other voltages on request. Please contact [support@comatreleco.com](mailto:support@comatreleco.com).

##### Accessories

Labels	BZS DIN 17.5 mm
--------	-----------------

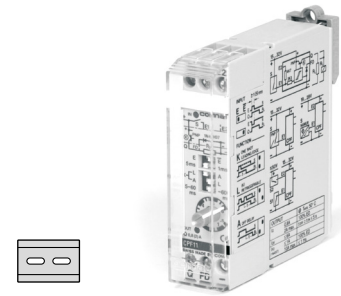


fig. 1. Wiring diagram

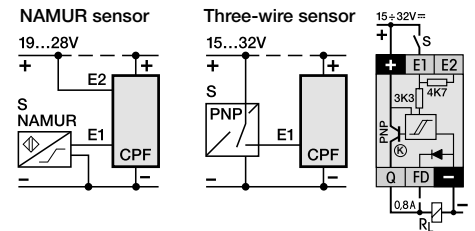
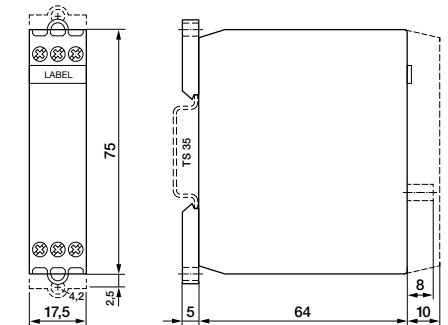


fig. 2. Dimensions (mm)



##### Standards and approvals

Standards IEC/EN 60947

Approvals

# CRV4

Multifunction | 24 ... 240 V UC | 1 CO | External potentiometer



### Time data

Timing functions	fig. 1 1: E 2: E, A, K, N, M, B1, F, G, Q, L, S, LS 3: W, B, B2, H
Timing range	50 ms ... 60 h
Timing scale	0.6 s / 6 s / 60 s / 6 min / 60 min / 6 h / 60 h

### Main circuit

Number of contacts	1 CO
Contact Material	AgNi
Rated voltage	250 V
Rated current	6 A
Minimum load	10 mA, 10 V
Inrush current	15 A, 10 ms
Rated load DC	fig. 2
Rated load AC-1	1500 VA
Mechanical endurance (cycles)	$3 \times 10^7$
Electrical endurance at rated load AC-1 (cycles)	fig. 3

### Control circuit

Nominal voltage	24 ... 240 V UC
Operating voltage range	19.2 ... 250 V
Power consumption AC / DC	0.55 VA / 0.55 W
Typ. input current on command input AC / DC	4 / 7 mA
Typ. threshold voltage on command input AC / DC	14.5 V / 17.5 V
Rated frequency	48 ... 63 Hz

### Insulation

Rated test voltage control / main circuit	2 kV rms / 1 min
Rated test voltage open contact	1 kV rms / 1 min
Pollution degree	2
Overvoltage category	III

### General data

Ambient temperature storage	-40 ... 85 °C
Ambient temperature operation	-40 ... 70 °C
Conductor cross section	2.5 mm <sup>2</sup> , 2 x 1 mm <sup>2</sup>
Nominal screw torque	0.6 Nm
Module width	fig. 4
Weight	50 g
Protection degree	IP 20
Housing material	PC

### Product references

Types	Product reference	24-240
UC supply	CRV4/UC...V	✓

"..." list control circuit voltage to complete product references.  
Other voltages on request. Please contact [support@comatreleco.com](mailto:support@comatreleco.com).

### Accessories

External potentiometer	SP-01/100K
------------------------	------------

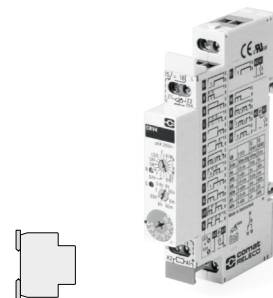


fig. 1. Wiring diagram

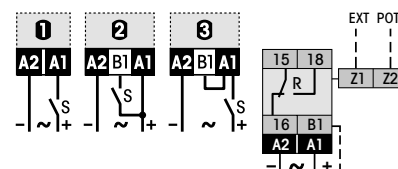


fig. 2. DC load limit curve

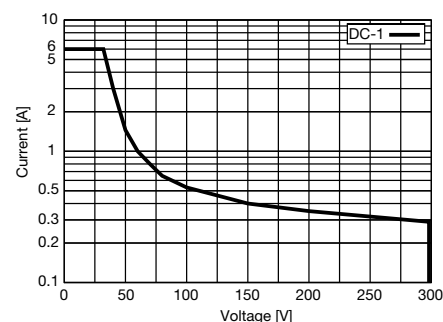


fig. 3. AC voltage endurance

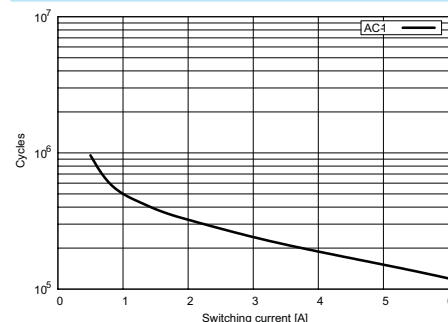
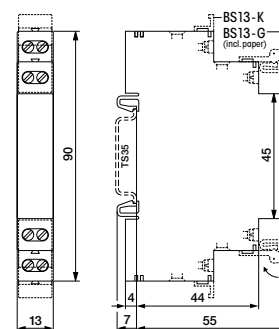


fig. 4. Dimensions (mm)



### Standards and approvals

Standards IEC/EN 60947

Approvals


# CSV4

Multifunction | 12 ... 36 V DC | 1 Mosfet | External potentiometer

### Time data

Timing functions	fig. 1 1: E 2: E, A, K, N, M, B1, F, G, Q, L, S, LS 3: W, B, B2, H
Timing range	0.8 ms ... 10 h
Timing scale	0.1 s / 1 s / 10 s / 1 min / 10 min / 1 h / 10 h

### Main circuit

Number of outputs	1 NO
Output type	 Mosfet
Output voltage range	10.2 ... 45 V (Potential of A1)
Rated current	1.5 A
Minimum load	1 mA, 10.2 V
Inrush current	4 A, 100 ms
Typ. leakage current	10 µA
Mechanical endurance (cycles)	∞
Electrical endurance at rated load DC-1 (cycles)	∞

### Control circuit

Nominal voltage	12 ... 36 V DC
Operating voltage range	10.2 ... 45 V
Power consumption AC / DC	- / 0.2 W
Typ. input current on command input AC / DC	- / 4 mA
Typ. threshold voltage on command input AC / DC	- / 7.3 V

### Insulation

Rated test voltage control / main circuit	2 kV rms / 1 min
Pollution degree	2
Overvoltage category	III

### General data

Ambient temperature storage	-40 ... 85 °C
Ambient temperature operation	-40 ... 70 °C
Conductor cross section	2.5 mm <sup>2</sup> , 2 x 1 mm <sup>2</sup>
Nominal screw torque	0.6 Nm
Module width	fig. 2
Weight	50 g
Protection degree	IP 20
Housing material	PC

### Product references

Types	Product reference	12-36
DC supply	CSV4/DC...V	✓

"..." list control circuit voltage to complete product references.  
Other voltages on request. Please contact support@comatreleco.com.

### Accessories

External potentiometer	SP-01/100K
------------------------	------------

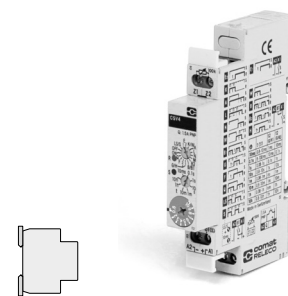


fig. 1. Wiring diagram

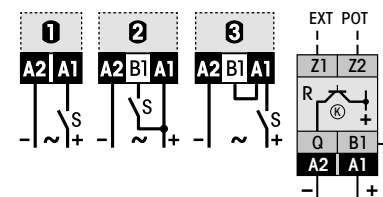
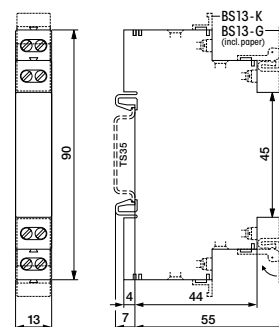


fig. 2. Dimensions (mm)



### Standards and approvals

Standards IEC/EN 60947

Approvals 



## 2.3 Star-Delta Relays

---

Application	Type	Page
<b>CY Series</b>		
Star-delta   24 ... 60 V UC   110 ... 240 V UC   1 NO + 1 CO	CY1	184

**Time data**

Timing functions	Y
Timing range	Star time: 0.5 s ... 60 s / switchover time 50 ms / 100 ms
Timing scale	6 s / 60 s

**Main circuit**

Number of contacts	1 NO + 1 CO
Contact Material	AgNi
Rated voltage	250 V
Rated current	6 A
Minimum load	10 mA, 10 V
Inrush current	30 A, 10 ms
Rated load DC	fig. 2
Rated load AC-1	1500 VA
Mechanical endurance (cycles)	$3 \times 10^7$
Electrical endurance at rated load AC-1 (cycles)	fig. 3

**Control circuit**

Nominal voltage	24 ... 60 V UC	110 ... 240 V UC
Operating voltage range	20 ... 75 V	90 ... 265 V
Power consumption AC / DC	1 VA / 1 W	
Rated frequency	48 ... 63 Hz	48 ... 63 Hz

**Insulation**

Rated test voltage control / main circuit	2 kV rms / 1 min
Rated test voltage main / main circuit	2 kV rms / 1 min
Rated test voltage open contact	1 kV rms / 1 min
Pollution degree	2
Overtoltage category	III

**General data**

Ambient temperature storage	-40 ... 85 °C
Ambient temperature operation	-25 ... 60 °C
Conductor cross section	2.5 mm <sup>2</sup> , 2 x 1.5 mm <sup>2</sup>
Nominal screw torque	0.4 Nm
Module width	fig. 4
Weight	76 g
Protection degree	IP 20
Housing material	PC

**Product references**

Types	Product reference	24-60	110-240
UC supply	CY1/UC...V	✓	✓

"..." list control circuit voltage to complete product references.

Other voltages on request. Please contact [support@comatreleco.com](mailto:support@comatreleco.com).

**Accessories**

Labels	BZS DIN 17.5 mm
--------	-----------------

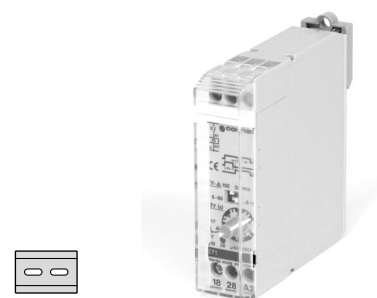


fig. 1. Wiring diagram

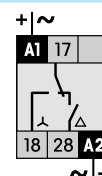


fig. 2. DC load limit curve

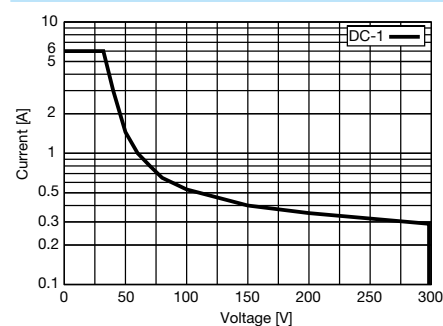


fig. 3. AC voltage endurance

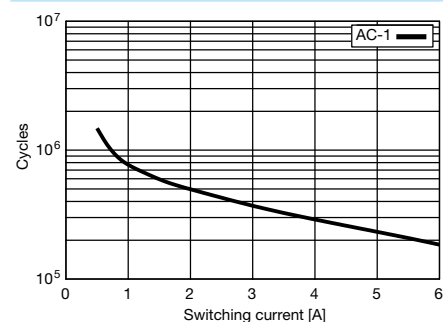
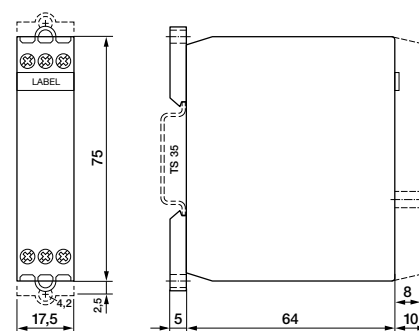


fig. 4. Dimensions (mm)

**Standards and approvals**

Standards IEC/EN 60947

Approvals



## 2.4 Time Relays - pluggable

Application	Type	Page
<b>C Series</b>		
Multifunction   24 ... 60 V UC   110 ... 240 V UC   2 CO	C55	186
Multifunction   24 ... 60 V UC   110 ... 240 V UC   1 Mosfet AC and DC	C55.3	187
Multifunction   24 V DC   1 Mosfet	C55.4	188
Multifunction   24 ... 60 V UC   110 ... 240 V UC   2 CO   Potential-free control	C56	189
Multifunction   24 ... 60 V UC   110 ... 240 V UC   2 CO   Off delay without control voltage	C64	190
Multifunction   24 ... 240 V UC   1 CO	C83	191
Multifunction   24 ... 240 V UC   1 CO	C85	192
<b>CS Series</b>		
Multifunction   12 ... 240 V UC   1 CO   External potentiometer	CS2	193
Multifunction   12 ... 240 V UC   2 CO	CS3	194
<b>RS Series</b>		
Multifunction   24 ... 48 V UC   220 ... 240 V AC   1 CO   Potential-free control	RS 41-M	195

**C55**

**Multifunction | 24 ... 60 V UC | 110 ... 240 V UC | 2 CO**



**Time data**

Timing functions	fig. 1 2: E, A, K, W, H, N, M, B, G, F, Q, I, P 3: E, W, H, B, I, P 4: U, V
Timing range	0.01 s ... 60 d
Timing scale	digital

**Main circuit**

Number of contacts	2 CO
Contact Material	AgNi
Rated voltage	250 V
Rated current	5 A
Minimum load	10 mA, 12 V
Inrush current	10 A, 10 ms
Rated load DC	fig. 2
Rated load AC-1	1250 VA
Mechanical endurance (cycles)	5 x 10 <sup>6</sup>
Electrical endurance at rated load AC-1 (cycles)	fig. 3

**Control circuit**

Nominal voltage	24 ... 60 V UC	110 ... 240 V UC
Operating voltage range	19 ... 75 V	88 ... 265 V
Power consumption AC / DC	2 VA / 2 W	
Typ. input current on command input AC / DC	6.3 / 6.3 mA	4.2 / 4.2 mA
Typ. threshold voltage on command input AC / DC	10 V / 10 V	40 V / 40 V
Rated frequency	48 ... 400 Hz	48 ... 400 Hz

**Insulation**

Rated test voltage control / main circuit	2 kV rms / 1 min
Rated test voltage main / main circuit	2 kV rms / 1 min
Rated test voltage open contact	1 kV rms / 1 min
Pollution degree	2
Overvoltage category	III

**General data**

Ambient temperature storage	-40 ... 85 °C
Ambient temperature operation	-25 ... 60 °C
Module width	fig. 4
Weight	80 g
Protection degree	IP 20
Housing material	PC

**Product references**

Types	Product reference	24-60	110-240
UC supply	C55/UC...V	✓	✓

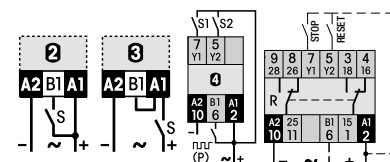
"..." list control circuit voltage to complete product references.  
Other voltages on request. Please contact support@comatreleco.com.

**Accessories**

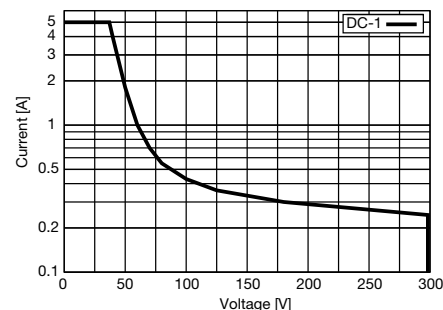
Sockets	S3-M
Retaining clip	HF-50
Transparent front cover	FA-50
Front panel mounting set	FZ-50L



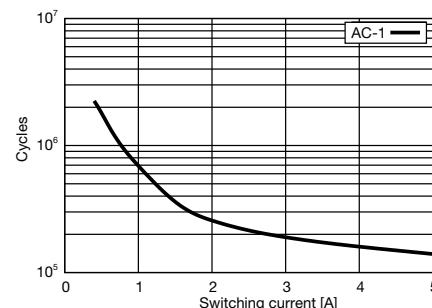
**fig. 1. Wiring diagram**



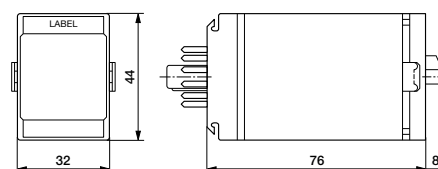
**fig. 2. DC load limit curve**



**fig. 3. AC voltage endurance**



**fig. 4. Dimensions (mm)**



**Standards and approvals**

Standards IEC/EN 60947

Approvals

## C55.3

Multifunction | 24 ... 60 V UC | 110 ... 240 V UC | 1 Mosfet AC and DC

### Time data

Timing functions	fig. 1 2: E, A, K, W, H, N, M, B, G, F, Q, I, P 3: E, W, H, B, I, P 4: U, V
Timing range	0.01 s ... 60 d
Timing scale	digital

### Main circuit

Number of outputs	1 NO
Output type	① Mosfet AC and DC
Output voltage range	10 ... 265 V
Rated current	0.5 A
Minimum load	1 mA, 10 V
Inrush current	6 A, 2 us
Rated load AC-1	132 VA
Mechanical endurance (cycles)	∞
Electrical endurance at rated load AC-1 (cycles)	∞
Electrical endurance at rated load DC-1 (cycles)	∞

### Control circuit

Nominal voltage	24 ... 60 V UC	110 ... 240 V UC
Operating voltage range	19 ... 75 V	88 ... 265 V
Power consumption AC / DC	2 VA / 2 W	
Typ. input current on command input AC / DC	6.3 / 6.3 mA	4.2 / 4.2 mA
Typ. threshold voltage on command input AC / DC	10 V / 10 V	40 V / 40 V
Rated frequency	48 ... 400 Hz	48 ... 400 Hz

### Insulation

Rated test voltage control / main circuit	2 kV rms / 1 min
Pollution degree	2
Overvoltage category	III

### General data

Ambient temperature storage	-40 ... 85 °C
Ambient temperature operation	-25 ... 60 °C
Module width	fig. 2
Weight	80 g
Protection degree	IP 20
Housing material	PC

### Product references

Types	Product reference	24-60	110-240
UC supply	C55.3/UC...V	✓	✓

"..." list control circuit voltage to complete product references.  
Other voltages on request. Please contact support@comatreleco.com.

### Accessories

Sockets	S3-M
Retaining clip	HF-50
Transparent front cover	FA-50
Front panel mounting set	FZ-50L



fig. 1. Wiring diagram

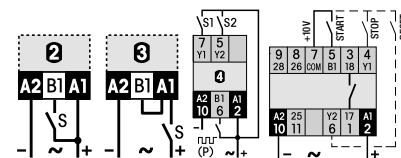
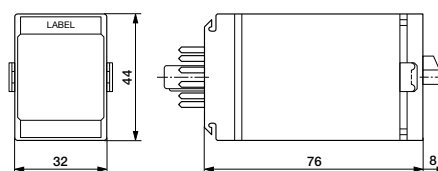


fig. 2. Dimensions (mm)



### Standards and approvals

Standards IEC/EN 60947

Approvals

## C55.4

### Multifunction | 24 V DC | 1 Mosfet

#### Time data

Timing functions	fig. 1 2: E, A, K, W, H, N, M, B, G, F, Q, I, P 3: E, W, H, B, I, P 4: U, V
Timing range	0.01 s ... 60 d
Timing scale	digital

#### Main circuit

Number of outputs	1 NO
Output type	Mosfet
Output voltage range	19 ... 30 V
Rated current	2 A
Minimum load	1 mA, 5 V
Inrush current	40 A, 150 us
Mechanical endurance (cycles)	∞
Electrical endurance at rated load AC-1 (cycles)	∞

#### Control circuit

Nominal voltage	24 V DC
Operating voltage range	19 ... 30 V
Power consumption AC / DC	- / 300 mW
Typ. input current on command input AC / DC	- / 5.5 mA
Typ. threshold voltage on command input AC / DC	- / 10 V

#### Insulation

Pollution degree	2
Overvoltage category	III

#### General data

Ambient temperature storage	-40 ... 85 °C
Ambient temperature operation	-25 ... 60 °C
Module width	fig. 2
Weight	80 g
Protection degree	IP 20
Housing material	PC

#### Product references

Types	Product reference	24
DC supply	C55.4/DC...V	✓

"..." list control circuit voltage to complete product references.

Other voltages on request. Please contact [support@comatreleco.com](mailto:support@comatreleco.com).

#### Accessories

Sockets	S3-M
Retaining clip	HF-50
Transparent front cover	FA-50
Front panel mounting set	FZ-50L



fig. 1. Wiring diagram

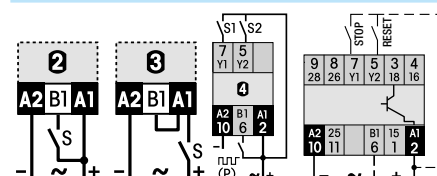
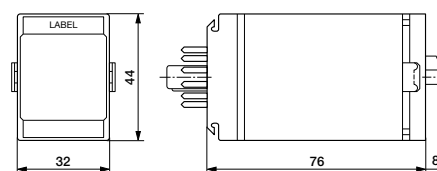


fig. 2. Dimensions (mm)



#### Standards and approvals

Standards IEC/EN 60947

Approvals

# C56

Multifunction | 24 ... 60 V UC | 110 ... 240 V UC | 2 CO | Potential-free control



### Time data

Timing functions	fig. 1 6: E, A, K, W, H, N, M, B, G, F, Q, I, P 7: E, W, H, B, I, P 5: U, V
Timing range	0.01 s ... 60 d
Timing scale	digital

### Main circuit

Number of contacts	2 CO
Contact Material	AgNi
Rated voltage	250 V
Rated current	5 A
Minimum load	10 mA, 12 V
Inrush current	10 A, 10 ms
Rated load DC	fig. 2
Rated load AC-1	1250 VA
Mechanical endurance (cycles)	5 x 10 <sup>6</sup>
Electrical endurance at rated load AC-1 (cycles)	fig. 3

### Control circuit

Nominal voltage	24 ... 60 V UC 110 ... 240 V UC
Operating voltage range	19 ... 75 V 88 ... 265 V
Power consumption AC / DC	2 VA / 2 W
Typ. input current on command input AC / DC	n.A.
Typ. threshold voltage on command input AC / DC	n.A. (10 V from COM)
Rated frequency	48 ... 400 Hz 48 ... 400 Hz

### Insulation

Rated test voltage control / main circuit	2 kV rms / 1 min
Rated test voltage main / main circuit	2 kV rms / 1 min
Rated test voltage open contact	1 kV rms / 1 min
Pollution degree	2
Overvoltage category	III

### General data

Ambient temperature storage	-40 ... 85 °C
Ambient temperature operation	-25 ... 60 °C
Module width	fig. 4
Weight	80 g
Protection degree	IP 20
Housing material	PC

### Product references

Types	Product reference	24-60	110-240
UC supply	C56/UC...V	✓	✓

"..." list control circuit voltage to complete product references.  
Other voltages on request. Please contact support@comatreleco.com.

### Accessories

Sockets	S3-M
Retaining clip	HF-50
Transparent front cover	FA-50
Front panel mounting set	FZ-50L



fig. 1. Wiring diagram

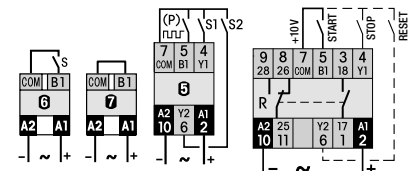


fig. 2. DC load limit curve

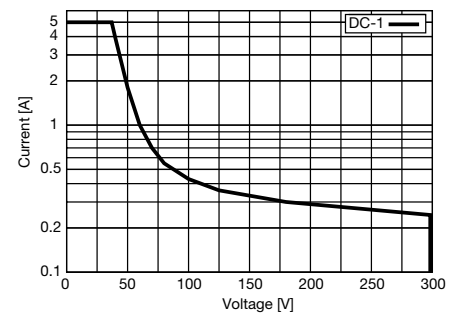


fig. 3. AC voltage endurance

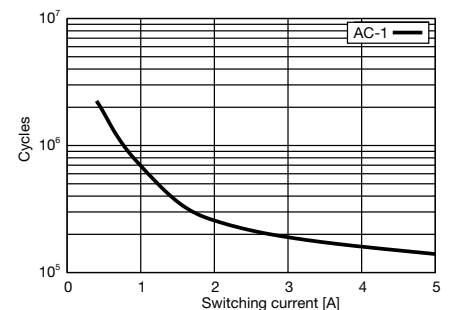
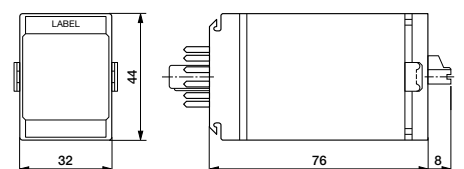


fig. 4. Dimensions (mm)



### Standards and approvals

Standards IEC/EN 60947



Approvals

**Multifunction | 24 ... 60 V UC | 110 ... 240 V UC | 2 CO | Off delay without control voltage**
**Time data**

Timing functions	A, N
Timing range	0.1 s ... 20 min
Timing scale	1.2 s / 12 s / 120 s / 20 min

**Main circuit**

Number of contacts	2 CO
Contact Material	AgNi
Rated voltage	250 V
Rated current	5 A
Minimum load	10 mA, 12 V
Inrush current	10 A, 10 ms
Rated load DC	fig. 2
Rated load AC-1	1250 VA
Mechanical endurance (cycles)	$5 \times 10^6$
Electrical endurance at rated load AC-1 (cycles)	fig. 3

**Control circuit**

Nominal voltage	24 ... 60 V UC	110 ... 240 V UC
Operating voltage range	20 ... 75 V	88 ... 265 V
Power consumption AC / DC	0.9 VA / 0.9 W	1.2 VA / 1.2 W
Rated frequency	48 ... 400 Hz	48 ... 400 Hz

**Insulation**

Rated test voltage control / main circuit	2 kV rms / 1 min
Rated test voltage main / main circuit	2 kV rms / 1 min
Rated test voltage open contact	1 kV rms / 1 min
Pollution degree	2
Overtoltage category	III

**General data**

Ambient temperature storage	-40 ... 85 °C
Ambient temperature operation	-25 ... 60 °C
Module width	fig. 4
Weight	75 g
Protection degree	IP 20
Housing material	PC

**Product references**

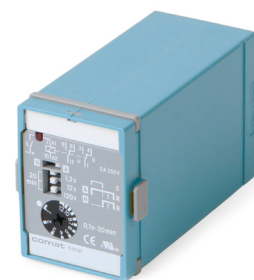
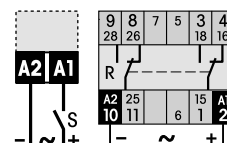
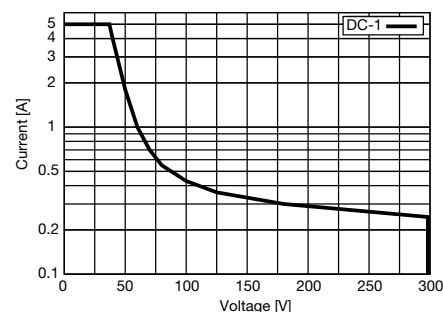
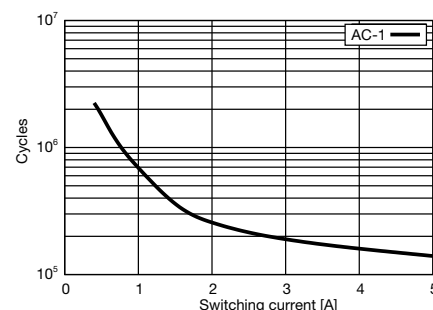
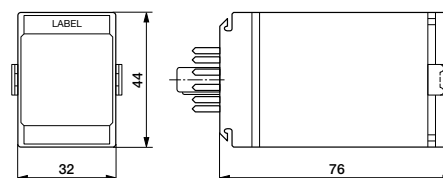
Types	Product reference	24-60	110-240
UC supply	C64/UC...V	✓	✓

"..." list control circuit voltage to complete product references.

Other voltages on request. Please contact [support@comatreleco.com](mailto:support@comatreleco.com).

**Accessories**

Sockets	S3-M
Retaining clip	HF-50
Transparent front cover	FA-50
Front panel mounting set	FZ-50L


**fig. 1. Wiring diagram**

**fig. 2. DC load limit curve**

**fig. 3. AC voltage endurance**

**fig. 4. Dimensions (mm)**

**Standards and approvals**

Standards IEC/EN 60947

Approvals

**Time data**

Timing functions	fig. 1 2: E, A, N, L, F, K, G, B1, Q 3: E, W, H, B
Timing range	50 ms ... 60 h
Timing scale	0.6 s / 6 s / 60 s / 6 min / 60 min / 6 h / 60 h

**Main circuit**

Number of contacts	1 CO
Contact Material	⚡ AgNi
Rated voltage	250 V
Rated current	8 A
Minimum load	10 mA, 10 V
Inrush current	30 A, 10 ms
Rated load DC	fig. 2
Rated load AC-1	2000 VA
Mechanical endurance (cycles)	$3 \times 10^7$
Electrical endurance at rated load AC-1 (cycles)	fig. 3

**Control circuit**

Nominal voltage	24 ... 240 V UC
Operating voltage range	20 ... 265 V
Power consumption AC / DC	9 VA / 1.6 W
Typ. input current on command input AC / DC	6.5 / 3.5 mA
Typ. threshold voltage on command input AC / DC	18 V / 18 V
Rated frequency	45 ... 63 Hz

**Insulation**

Rated test voltage control / main circuit	2 kV rms / 1 min
Rated test voltage open contact	1 kV rms / 1 min
Pollution degree	2
Overvoltage category	III

**General data**

Ambient temperature storage	-40 ... 85 °C
Ambient temperature operation	-25 ... 60 °C
Module width	fig. 4
Weight	60 g
Protection degree	IP 20
Housing material	PC

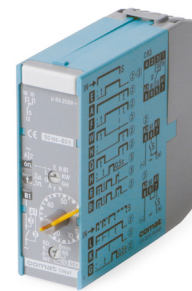
**Product references**

Types	Product reference	24-240
UC supply	C83/UC...V	✓

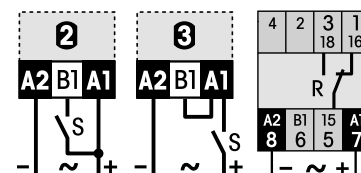
"..." list control circuit voltage to complete product references.  
Other voltages on request. Please contact support@comatreleco.com.

**Accessories**

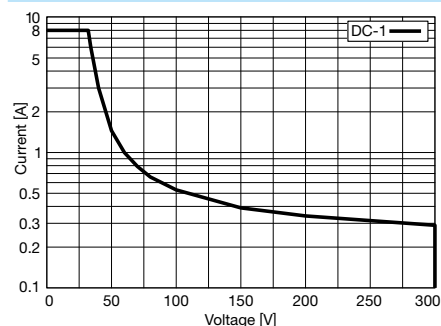
Sockets	S7-C
---------	------



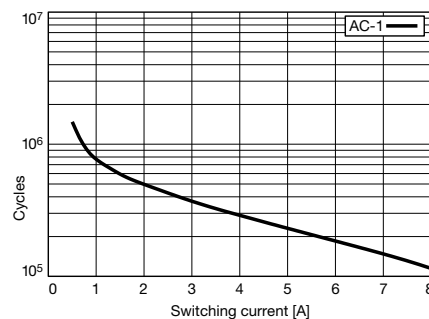
**fig. 1. Wiring diagram**



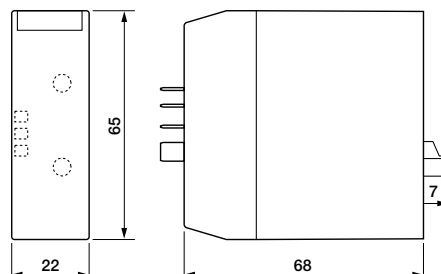
**fig. 2. DC load limit curve**



**fig. 3. AC voltage endurance**



**fig. 4. Dimensions (mm)**



**Standards and approvals**

Standards IEC/EN 60947

Approvals

# C85

## Multifunction | 24 ... 240 V UC | 1 CO

### Time data

Timing functions	fig. 1 2: F, G, Q, I, P 3: H, I, P
Timing range	50 ms ... 60 h
Timing scale	0.6 s / 6 s / 60 s / 6 min / 60 min / 6 h / 60 h

### Main circuit

Number of contacts	1 CO
Contact Material	AgNi
Rated voltage	250 V
Rated current	8 A
Minimum load	10 mA, 10 V
Inrush current	30 A, 10 ms
Rated load DC	fig. 2
Rated load AC-1	1250 VA
Mechanical endurance (cycles)	$3 \times 10^7$
Electrical endurance at rated load AC-1 (cycles)	fig. 3

### Control circuit

Nominal voltage	24 ... 240 V UC
Operating voltage range	20 ... 265 V
Power consumption AC / DC	9 VA / 1.6 W
Typ. input current on command input AC / DC	6.5 / 3 mA
Typ. threshold voltage on command input AC / DC	18 V / 18 V
Rated frequency	45 ... 63 Hz

### Insulation

Rated test voltage control / main circuit	2 kV rms / 1 min
Rated test voltage open contact	1 kV rms / 1 min
Pollution degree	2
Overvoltage category	III

### General data

Ambient temperature storage	-40 ... 85 °C
Ambient temperature operation	-25 ... 60 °C
Module width	fig. 4
Weight	63 g
Protection degree	IP 20
Housing material	PC

### Product references

Types	Product reference	24-240
UC supply	C85/UC...V	✓

"..." list control circuit voltage to complete product references.  
Other voltages on request. Please contact [support@comatreleco.com](mailto:support@comatreleco.com).

### Accessories

Sockets	S7-C
---------	------

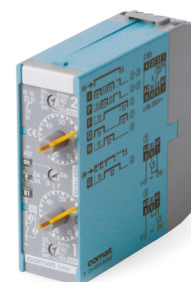


fig. 1. Wiring diagram

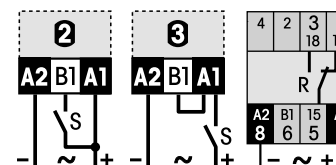


fig. 2. DC load limit curve

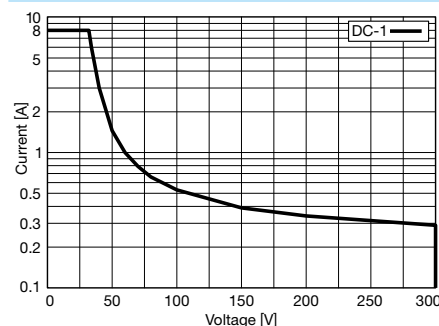


fig. 3. AC voltage endurance

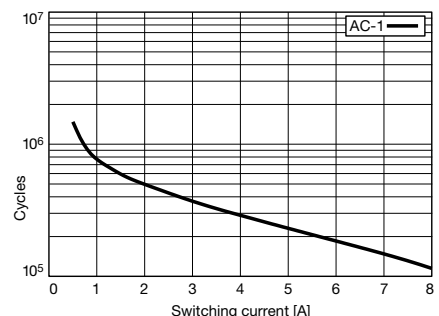
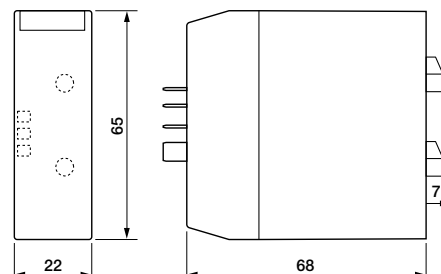


fig. 4. Dimensions (mm)



### Standards and approvals

Standards IEC/EN 60947

Approvals



# CS2

Multifunction | 12 ... 240 V UC | 1 CO | External potentiometer

### Time data

Timing functions	fig. 1 1: E, W, B, B2 2: A, E, K, N
Timing range	50 ms ... 60 h
Timing scale	0.6 s / 6 s / 60 s / 6 min / 60 min / 6 h / 60 h

### Main circuit

Number of contacts	1 CO
Contact Material	AgNi
Rated voltage	250 V
Rated current	8 A
Minimum load	10 mA, 10 V
Inrush current	30 A, 10 ms
Rated load DC	fig. 2
Rated load AC-1	2000 VA
Mechanical endurance (cycles)	$3 \times 10^7$
Electrical endurance at rated load AC-1 (cycles)	fig. 3

### Control circuit

Nominal voltage	12 ... 240 V UC
Operating voltage range	10.2 ... 265 V
Power consumption AC / DC	0.9 VA / 1.6 W
Typ. input current on command input AC / DC	6 / 2 mA
Typ. threshold voltage on command input AC / DC	6.5 V / 7 V
Rated frequency	45 ... 63 Hz

### Insulation

Rated test voltage control / main circuit	2.5 kV rms / 1 min
Rated test voltage open contact	1 kV rms / 1 min
Pollution degree	2
Overvoltage category	III

### General data

Ambient temperature storage	-40 ... 85 °C
Ambient temperature operation	-25 ... 60 °C
Module width	fig. 4
Weight	75 g
Protection degree	IP 20
Housing material	PC

### Product references

Types	Product reference	12-240
UC supply	CS2/UC...V	✓

"..." list control circuit voltage to complete product references.  
Other voltages on request. Please contact support@comatreleco.com.

### Accessories

External potentiometer	SP-01/1M
Sockets	S3-M
Retaining clip	HF-50
Transparent front cover	FA-50
Front panel mounting set	FZ-50L

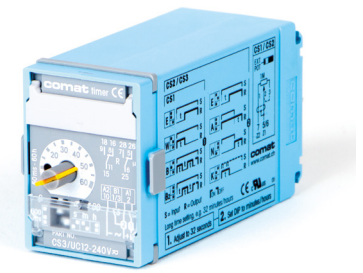


fig. 1. Wiring diagram

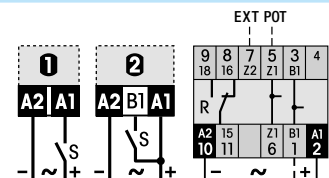


fig. 2. DC load limit curve

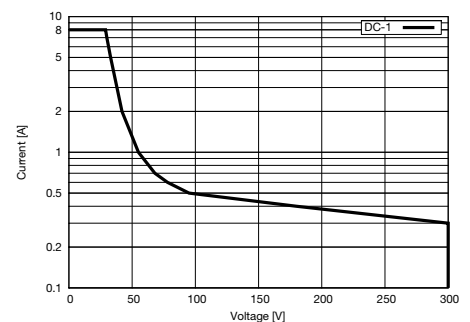


fig. 3. AC voltage endurance

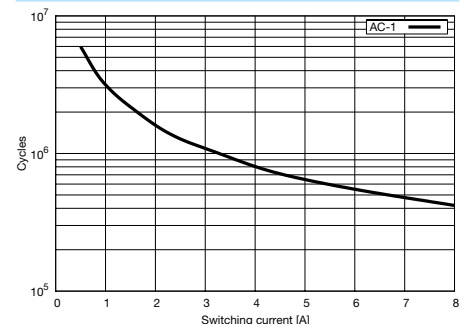
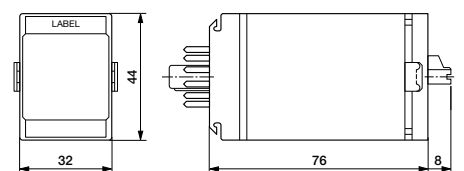


fig. 4. Dimensions (mm)



### Standards and approvals

Standards IEC/EN 60947

Approvals

**Time data**

Timing functions	fig. 1 1: E, W, B, B2 2: A, E, K, N
Timing range	50 ms ... 60 h
Timing scale	0.6 s / 6 s / 60 s / 6 min / 60 min / 6 h / 60 h

**Main circuit**

Number of contacts	2 CO
Contact Material	AgNi
Rated voltage	250 V
Rated current	6 A
Minimum load	10 mA, 10 V
Inrush current	10 A, 10 ms
Rated load DC	fig. 2
Rated load AC-1	1500 VA
Mechanical endurance (cycles)	$3 \times 10^7$
Electrical endurance at rated load AC-1 (cycles)	fig. 3

**Control circuit**

Nominal voltage	12 ... 240 V UC
Operating voltage range	10.2 ... 265 V
Power consumption AC / DC	0.9 VA / 1.6 W
Typ. input current on command input AC / DC	6 / 2 mA
Typ. threshold voltage on command input AC / DC	6.5 V / 7 V
Rated frequency	45 ... 63 Hz

**Insulation**

Rated test voltage control / main circuit	2.5 kV rms / 1 min
Rated test voltage main / main circuit	2.5 kV rms / 1 min
Rated test voltage open contact	1 kV rms / 1 min
Pollution degree	2
Overvoltage category	III

**General data**

Ambient temperature storage	-40 ... 85 °C
Ambient temperature operation	-25 ... 60 °C
Module width	fig. 4
Weight	75 g
Protection degree	IP 20
Housing material	PC

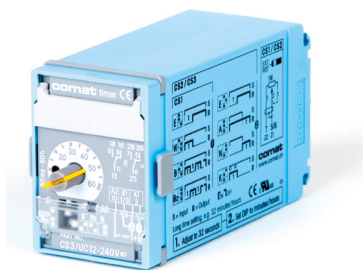
**Product references**

Types	Product reference	12-240
UC supply	CS3/UC...V	✓

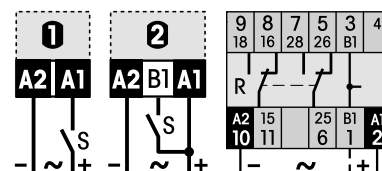
"..." list control circuit voltage to complete product references.  
Other voltages on request. Please contact [support@comatreleco.com](mailto:support@comatreleco.com).

**Accessories**

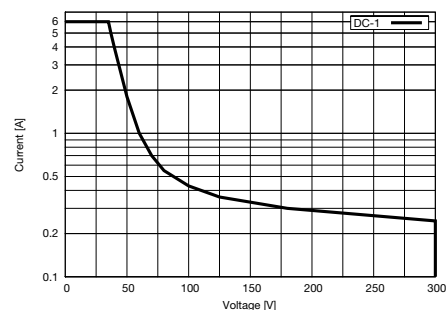
Sockets	S3-M
Retaining clip	HF-50
Transparent front cover	FA-50
Front panel mounting set	FZ-50L



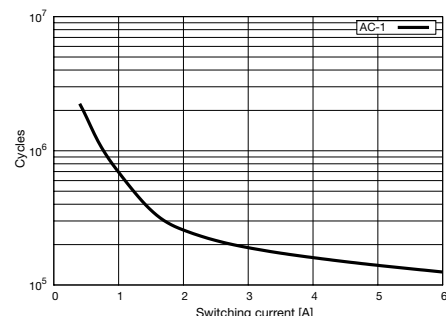
**fig. 1. Wiring diagram**



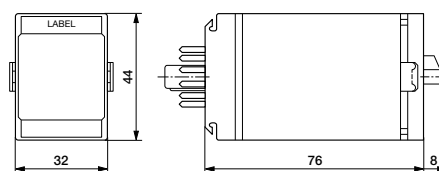
**fig. 2. DC load limit curve**



**fig. 3. AC voltage endurance**



**fig. 4. Dimensions (mm)**



**Standards and approvals**

Standards IEC/EN 60947

Approvals

# RS 41-M

Multifunction | 24 ... 48 V UC | 220 ... 240 V AC | 1 CO | Potential-free control

### Time data

Timing functions	fig. 1 4: E, 5: A, 6: K, 1: W, I
Timing range	0.1 s ... 15 min
Timing scale	1.5 s / 15 s / 15 min

### Main circuit

Number of contacts	1 CO
Contact Material	AgNi
Rated voltage	250 V
Rated current	6 A
Minimum load	10 mA, 10 V
Inrush current	10 A, 10 ms
Rated load DC	fig. 2
Rated load AC-1	1500 VA
Mechanical endurance (cycles)	$2 \times 10^7$
Electrical endurance at rated load AC-1 (cycles)	fig. 3

### Control circuit

Nominal voltage	24 ... 48 V UC	220 ... 240 V AC
Operating voltage range	19 ... 53 V UC	187 ... 265 V AC
Power consumption AC / DC	0.48 VA / 0.48 W	2.4 VA / 2.4 W
Typ. input current on command input AC / DC	n.A.	
Typ. threshold voltage on command input AC / DC	n.A. (8 V from Terminal 4)	
Rated frequency	45 ... 63 Hz	45 ... 63 Hz

### Insulation

Rated test voltage control / main circuit	2 kV rms / 1 min
Rated test voltage open contact	1 kV rms / 1 min
Pollution degree	2
Overvoltage category	III

### General data

Ambient temperature storage	-40 ... 85 °C
Ambient temperature operation	-25 ... 60 °C
Module width	fig. 4
Weight	75 g
Protection degree	IP 20
Housing material	PC

### Product references

Types	Product reference	24-48	220-240
UC supply	RS 41-M/UFK UC...V	✓	
AC supply	RS 41-M/ATX AC...V		✓

"..." list control circuit voltage to complete product references.  
Other voltages on request. Please contact support@comatreleco.com.

### Accessories

Sockets	S3-M
Retaining clip	HF-50



fig. 1. Wiring diagram

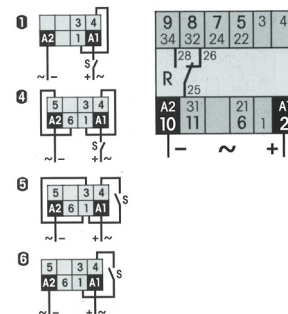


fig. 2. DC load limit curve

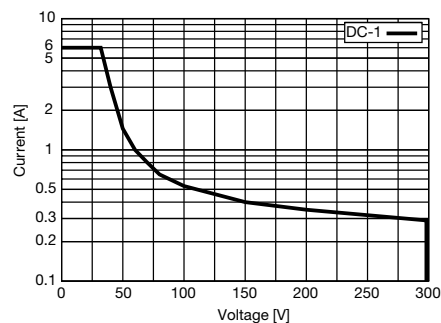


fig. 3. AC voltage endurance

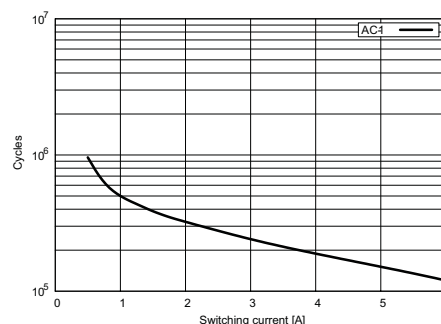
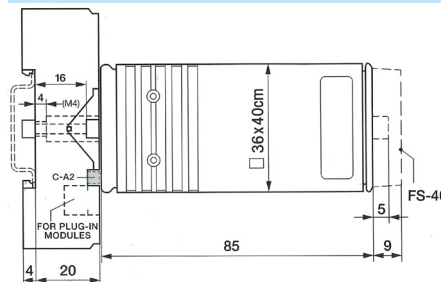


fig. 4. Dimensions (mm)



### Standards and approvals

Standards IEC/EN 60947

Approvals



## 2.5 Timers & Twilight Switches

Application	Type	Page
<b>CPU Series</b>		
Digital timer   230 V AC   1 CO	CPU	198
<b>QSU Series</b>		
Mechanical timer   230 V AC   1 CO	QSU	199
<b>EDS Series</b>		
Mechanical timer   230 V AC   1 CO	EDS17	200
Mechanical timer   230 V AC   1 CO	EDS35	201

**CPU****Digital Timer 16 A / 230 V AC-1**

Type	CPU 35WU-JS	CPU 35W2U-JS	CPU 35WU-LCD	CPU 35W2U-LCD
	Digital Weekly Menu-guided timer, multilingual	Digital Weekly Timer menu-driven, two-channel, multilingual	Digital Weekly timer	Digital Weekly Timer two-channel
Time program	Week, cycle and random program Permanent operation and holiday program   pulse 1...99 s   Automatic leap year correction   Hour meter and maintenance program   External input for switch or button		Week	Week
Memory Spaces	64	64	20	20
Shortest switching time	1 min	1 min	1 sec	1 sec
Summer/winter time changeover	automatic	automatic	automatic	automatic
Power reverse	6 Years	6 Years	15 Days	15 Days
Number of contacts	1	2	1	2
Load AC-1	16 A / 230 V	16 A / 230 V	16 A / 230 V	16 A / 230 V
Operating voltage	230 V AC	230 V AC	230 V AC	230 V AC
Operating temperature	0...+50 °C	0...+50 °C	-10...+50 °C (No ice)	-10...+50 °C (No ice)

**Specifications**

Protection degree

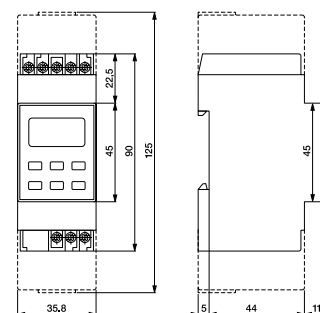
IP 20

Weight

163 g

**Product References****AC 230 V**

**CPU 35 WU-JS/AC230V**  
**CPU 35 W2U-JS/AC230V**  
**CPU 35 WU-LCD/AC230V**  
**CPU 35 W2U-LCD/AC230V**

**Dimensions (mm)****Technical approvals, conformities**

**QSU**

**Mechanical timer 16 A / 230 V AC-1**



Type	QSU 35U	QSU 35WU
	Mechanical day timer	Mechanical week timer
Time schedule	Day	Week
Memory Space	1	1
Shortest switching time	30 min	30 min
Summer / winter-time changeover	-	-
power reverse	150 h	150 h
Number of contacts	1	1
Load AC-1	16 A / 230 V	16 A / 230 V
Operating voltage	230 V AC	230 V AC
Operating temperature	0...+50 °C	0...+50 °C

**Specifications**

Protection degree	IP 20
Weight	134 g

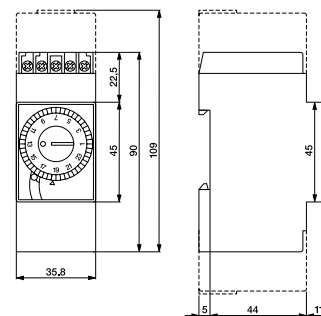
**Product References**

AC 230 V

QSU 35 U/AC230V  
QSU 35 WU/AC230V



**Dimensions (mm)**



**Technical approvals, conformities**



## EDS17

### Twilight switch 16 A / 230 V AC-1



#### Specifications

Setting ranges	0...100 Lux 0...1000 Lux OFF Permanent light
Turn-on delay	15 s
Off-delay	30 s
Number of contacts	1
Load AC-1	16 A / 230 V
Operating voltage	230 V AC
Operating temperatur	-10...55 °C (No ice)
Protection degree	IP 20
Weight	100 g



#### Product References

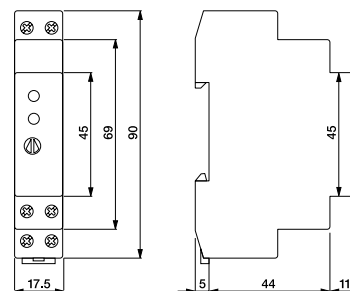
AC 230 V

EDS17A/AC230V

#### Accessories

Light sensor	EDS/LF
--------------	--------

#### Dimensions (mm)



#### Technical approvals, conformities



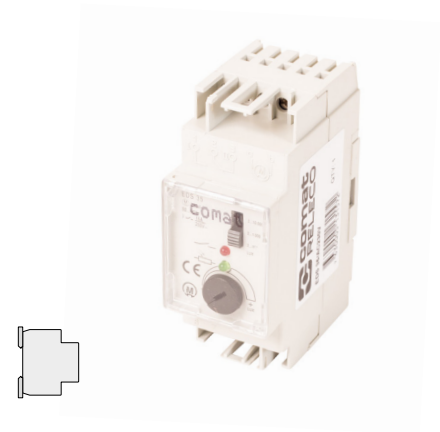
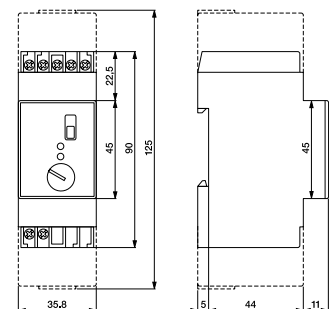


**EDS35****Twilight switch 16 A / 230 V AC-1****Specifications**

Setting ranges	0...100 Lux 0...1000 Lux 0...10000 Lux
Turn-on delay	8 s
Off-delay	38 s
Number of contacts	1
Load AC-1	16 A / 230 V
Operating voltage	230 V AC
Operating temperatur	-10...55 °C (No ice)
Protection degree	IP 20
Weight	234 g

**Product References****AC 230 V****EDS35/AC230V****Accessories**

Light sensor EDS/LF

**Dimensions (mm)****Technical approvals, conformities**



## 2.6 Time Cubes

---

Application	Type	Page
<b>CT Series</b>		
Single function   multivoltage	CT2	204
Single function   multivoltage	CT3	205

**CT2****Single function | multivoltage****Time data**

Timing functions	fig. 1 1: E, B 2: A, K 3: W
Timing range	0.2 s ... 30 min
Timing scale	3 s / 30 s / 3 min / 30 min

**Control circuit 1 / 2**

Operating voltage range	9.5 ... 18 V DC	20 ... 65 V UC	90 ... 150 V UC
Power consumption AC / DC	0.2 VA / W	0.4 VA / W	0.3 VA / W
Typ. input current on command input AC / DC	- / 0.2 mA	0.2 / 0.2 mA	0.2 / 0.2 mA
Typ. threshold voltage on command input AC / DC	9 V	18 V	75 V

**Control circuit 2 / 2**

Operating voltage range	180 ... 265 V UC	90 ... 265 V UC
Power consumption AC / DC	0.5 VA / W	0.5 VA / W
Typ. input current on command input AC / DC	0.2 / 0.2 mA	0.2 / 0.2 mA
Typ. threshold voltage on command input AC / DC	140 V	75 V

**General data**

Ambient temperature storage	-40 ... 85 °C
Ambient temperature operation	-25 ... 60 °C
Conductor cross section	2.5 mm <sup>2</sup>
Nominal screw torque	0.5 Nm
Module width	fig. 2
Weight	35 g
Protection degree	IP 20
Housing material	PC

**Product references**

Types	Product reference	S DC9.5-18	L UC20-65	M 90-150	U 180-265	H 90-265
Off delay	CT2-A30/...V	✓	✓	✓	✓	
Blinker	CT2-B30/...V	✓	✓			✓
On delay	CT2-E30/...V	✓	✓			✓
Pulse shaping, one shot	CT2-K30/...V	✓	✓	✓	✓	

"..." list control circuit voltage to complete product references.

Other voltages on request. Please contact [support@comatreleco.com](mailto:support@comatreleco.com).

**Accessories**

Sockets	S2-B, S2-P0
Retaining clip	HF-33

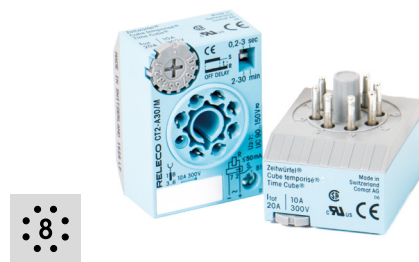


fig. 1. Wiring diagram

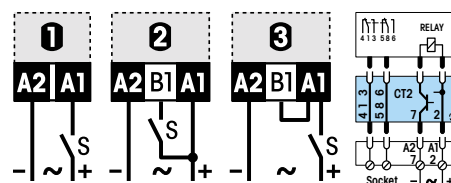
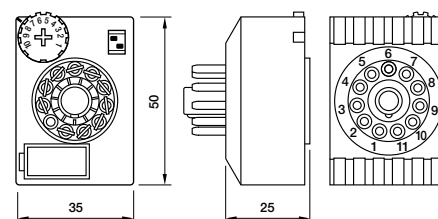


fig. 2. Dimensions (mm)

**Standards and approvals**

Standards IEC/EN 60947

Approvals

**CT3****Single function | multivoltage****Time data**

Timing functions	fig. 1 1: E, B 2: A, K 3: W
Timing range	0.2 s ... 30 min
Timing scale	3 s / 30 s / 3 min / 30 min

**Control circuit 1 / 2**

Operating voltage range	9.5 ... 18 V DC	20 ... 65 V UC	90 ... 150 V UC
Power consumption AC / DC	0.2 VA / W	0.4 VA / W	0.3 VA / W
Typ. input current on command input AC / DC	- / 0.2 mA	0.2 / 0.2 mA	0.2 / 0.2 mA
Typ. threshold voltage on command input AC / DC	9 V	18 V	75 V

**Control circuit 2 / 2**

Operating voltage range	180 ... 265 V UC	90 ... 265 V UC
Power consumption AC / DC	0.5 VA / W	0.5 VA / W
Typ. input current on command input AC / DC	0.2 / 0.2 mA	0.2 / 0.2 mA
Typ. threshold voltage on command input AC / DC	140 V	75 V

**General data**

Ambient temperature storage	-40 ... 85 °C
Ambient temperature operation	-25 ... 60 °C
Conductor cross section	2.5 mm <sup>2</sup>
Nominal screw torque	0.5 Nm
Module width	fig. 2
Weight	35 g
Protection degree	IP 20
Housing material	PC

**Product references**

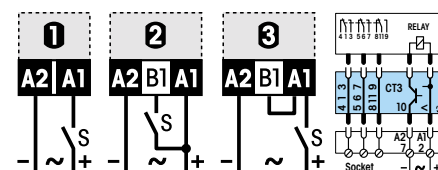
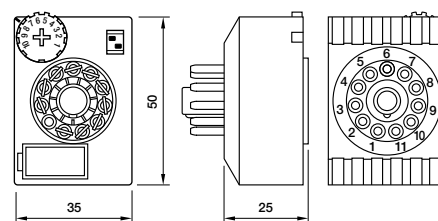
Types	Product reference	S DC9.5-18	L UC20-65	M 90-150	U 180-265	H 90-265
Off delay	CT3-A30/...V	✓	✓	✓	✓	
Blinker	CT3-B30/...V	✓	✓			✓
On delay	CT3-E30/...V	✓	✓			✓
Pulse shaping, one shot	CT3-K30/...V	✓	✓	✓	✓	

"..." list control circuit voltage to complete product references.

Other voltages on request. Please contact [support@comatreleco.com](mailto:support@comatreleco.com).

**Accessories**

Sockets	S3-M
Retaining clip	HF-33

**fig. 1. Wiring diagram****fig. 2. Dimensions (mm)****Standards and approvals**

Standards IEC/EN 60947

Approvals



## 2.7 Time Modules

---

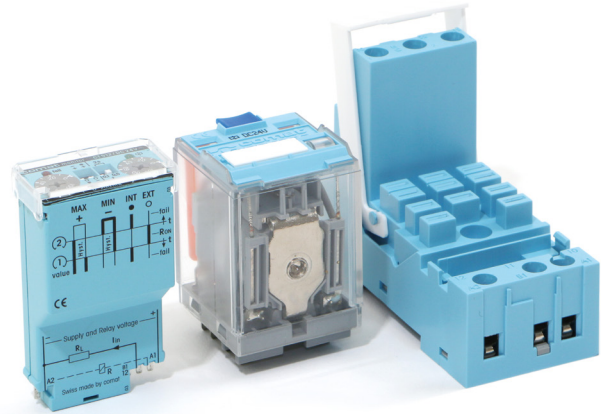
Application	Type	Page
<b>CT Series</b>		
Multifunction   24 ... 48 V UC   110 V DC	CT32R	209
Multifunction   24 ... 48 V UC   115 V UC   230 V UC	CT33R	210
Multifunction   24 ... 48 V UC   110 ... 240 V UC	CT36R	211

## The modular ComatReleco timer CT System

The time delay relays and monitoring relays consist of plug-in CT electronic modules and 11 pole output relays. Both system components can be combined in a variety of combinations. This allows adapting the system for the specific application.

Subsequent modifications, for example a change from mechanical contacts to solid-state outputs, are possible at any time just by replacing the relay.

This system provides the user a complete universal system with worldwide unmatched flexibility.



**The system sockets** S3-M0 or C-155 serve as a basis for the secure reception of the electronic modules. The sockets have a 4 pole module slot in which the CT modules lock firmly and vibration proof also without the output relay. Contact is made with reliable twin knife contacts.

With the A2 connector bridge "C-A2", the neutral conductor (N/-) can be connected from socket to socket. It reduces wiring work considerably.

Robust terminals for wires up to 4 mm<sup>2</sup> and spacious labelling are other advantages of this practical ComatReleco modular system.

Clear markings close to the terminal connections on the sockets make it easy to identify the connections for wiring and servicing.

**The CT modules** are proof of the practical oriented experiences of ComatReleco in the field of industrial electronics. All control and display elements are arranged easy accessible at all times on the front side of the modules. The functions and settings are self-explanatory schematically illustrated on the front and allow to review the set values also during operation.

A transparent cover over the module setting components provides protection from unintentional settings and additionally links the module to the output relay.

Triggering is performed with the operating voltage. (L1 or +). No potential-free contacts are therefore required. The triggering complies to machine standards. Parallel connection to B1 is admissible.

**The wide UC voltage range** (AC/DC) of the modules give a wide flexibility. It permits the connection to AC or DC supplies and provides a high level of reliability in triggering.

Note: In case of even wider voltage ranges, for example UC 24-240V, triggering currents on B1 are often in the range of 100µA with simultaneous low threshold voltages of less than 20V. Due to capacitive or inductive pick-ups this may lead to unintentional triggering or switching errors caused by insufficient load on the control contacts (It is not seldom that 50V or more can be measured in open lines).

**The output relays** show the connection diagram and the technical values on the front side, (exception C3 and C5 relays). A colour code indicates an AC coil with red and a DC coil with blue colour. Most of the relays have a lockable test button for manual operation.

**The standard contacts** have proven its reliability for high switching current applications over many years. The contact material AgNi permits a wide switching range and due to the large dimensioning they are designed for a high number of switching cycles. The high breaking capacity of up to 10A/400V and a low load switching capability of 12V/10mA makes the contact suitable for the use in main circuits as well as for low voltage applications.

**The twin contacts** are switching the load circuit with 2 independent contact tongues. The switching safety for low currents is therefore 100 times higher compared to a single contact relay. Despite the high switching capacity of up to 6A/250V, these contacts are very suitable to switch low currents and voltages up to 1mA/6V.

**The solid-state relays** are an alternative to mechanical relays. In the standard version, the relay has a potential-free universal semiconductor output for AC or DC loads. The advantage is a bouncing- and wear-free, overload resistant, short circuit protected output with a practical unlimited life cycle.

Solid-state relays are specially recommended for applications of high switching cycles, for example for repeat cycle timers, flushing lights, but also for high inductive switching loads of solenoid valves, couplings, motors, etc. The solid state relays are also suitable for capacitive loads, for example long power lines, or compensated lighting circuits.

Additional protection circuits of the output or of the load are not necessary in any application for this type of ComatReleco relays.

The solid-state relays are insensitive in any aggressive environment such as chemical plants, sewage plants etc. and are therefore an excellent choice for the employment in such environments.



The train symbol indicates products available in a special railway execution according EN 50155. Please refer to our special railway brochure for details.



# CT32R

Multifunction | 24 ... 48 V UC | 110 V DC



### Time data

Timing functions	fig. 1 2: E, A, K, N, B1 3: E, W, B
Timing range	1.5 s / 6 s / 15 s / 60 s / 1.5 min / 6 min / 15 min / 60 min
Timing scale	0.15 s ... 60 min

### Control circuit

Nominal voltage	24 ... 48 V UC	110 V DC
Operating voltage range	19 ... 60 V	77 ... 138 V
Power consumption AC / DC	0.3 VA / 0.3 W	- / 0.3 W
Typ. threshold voltage on command input AC / DC	9 V	60 V

### General data

Ambient temperature storage	-40 ... 85 °C
Ambient temperature operation railway version	-40 ... 70 °C
Module width	fig. 2
Weight	25 g
Protection degree	IP 20
Housing material	PC

### Product references

Types	Product reference	24-48 110
DC supply	CT32R/DC...V	✓
UC supply	CT32R/UC...V	✓

"..." list control circuit voltage to complete product references.  
Other voltages on request. Please contact [support@comatreleco.com](mailto:support@comatreleco.com).

### Accessories

Sockets	S3-M0, S5-M
Transparent front cover	FS-C



fig. 1. Wiring diagram

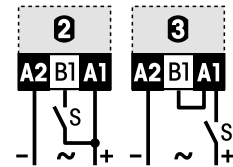
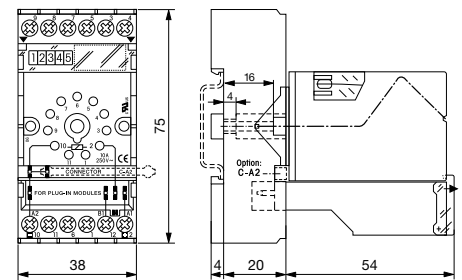


fig. 2. Dimensions (mm)



### Standards and approvals

Standards IEC/EN 50155

Approvals CE EAC us

**CT33R****Multifunction | 24 ... 48 V UC | 115 V UC | 230 V UC****Time data**

Timing functions	fig. 1 2: E, A, K, N, B1, F, G, Q, L 3: E, W, B, H
Timing range	150 ms / 600 ms / 1.5 s / 6 s / 15 s / 60 s / 1.5 min / 6 min / 60 min / 1.5 h / 6 h / 15 h / 60 h
Timing scale	30 ms ... 60 h

**Control circuit**

Nominal voltage	24 ... 48 V UC	115 V UC	230 V UC
Operating voltage range	19 ... 60 V	90 ... 150 V	180 ... 265 V
Power consumption AC / DC	0.3 VA / 0.3 W	0.5 VA / 0.5 W	1 VA / 1 W
Typ. threshold voltage on command input AC / DC	9 V	60 V	100 V

**General data**

Ambient temperature storage	-40 ... 85 °C
Ambient temperature operation railway version	-40 ... 70 °C
Module width	fig. 2
Weight	25 g
Protection degree	IP 20
Housing material	PC

**Product references**

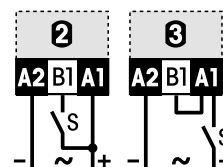
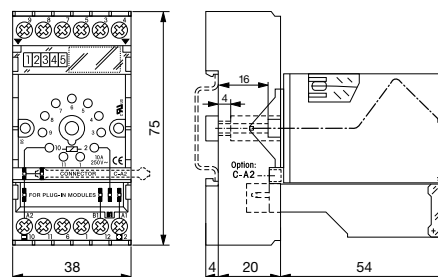
Types	Product reference	24-48	115	230
UC supply	CT33R/UC...V	✓	✓	✓

"..." list control circuit voltage to complete product references.

Other voltages on request. Please contact [support@comatreleco.com](mailto:support@comatreleco.com).

**Accessories**

Sockets	S3-M0, S5-M
Transparent front cover	FS-C

**fig. 1. Wiring diagram****fig. 2. Dimensions (mm)****Standards and approvals**

Standards IEC/EN 50155

Approvals

# CT36R

Multifunction | 24 ... 48 V UC | 110 ... 240 V UC



**Time data**

Timing functions	I, P	
Timing range	600 ms / 6 s / 60 s / 6 min / 60 min / 60 h	
Timing scale	50 ms ... 60 h	

**Control circuit**

Nominal voltage	24 ... 48 V UC	110 ... 240 V UC
Operating voltage range	19 ... 60 V	82 ... 265 V
Power consumption AC / DC	0.3 VA / 0.3 W	1 VA / 1 W

**General data**

Ambient temperature storage	-40 ... 85 °C
Ambient temperature operation railway version	-40 ... 70 °C
Module width	fig. 2
Weight	25 g
Protection degree	IP 20
Housing material	PC

**Product references**

Types	Product reference	24-48 110-240	
UC supply	CT36R/UC...V	✓	✓

"..." list control circuit voltage to complete product references.  
Other voltages on request. Please contact support@comatreleco.com.

**Accessories**

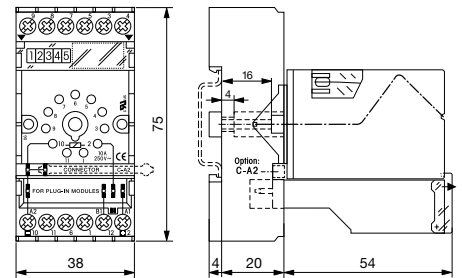
Sockets	S3-M0, S5-M
Transparent front cover	FS-C



fig. 1. Wiring diagram



fig. 2. Dimensions (mm)



**Standards and approvals**

Standards IEC/EN 50155

Approvals



## 2.8 Timing Relay Accessories

Application	Type	Page
<b>Accessories</b>		
Potentiometer   100 kΩ   1 MΩ   0.2 W	SP-01	214
Label	BZS DIN 17.5 mm	215
Retaining clip   Steel	HF-32	216
Retaining clip   Steel	HF-33	217
Retaining clip   Steel	HF-50	218
Transparent front cover	FA-50	219
Front panel mounting set   Socket S3-L   Retaining clip	FZ-50L	220
Transparent front cover	FS-C	221

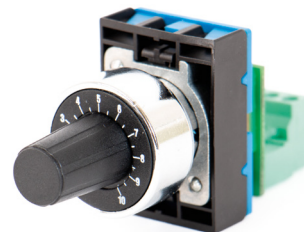
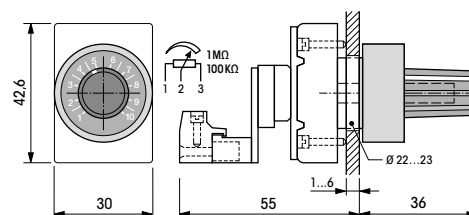
**SP-01****Potentiometer | 100 kΩ | 1 MΩ | 0.2 W****General data**

Ambient temperature storage	-40 ... 85 °C
Ambient temperature operation	-25 ... 60 °C
Conductor cross section	2.5 mm <sup>2</sup>
Nominal screw torque	0.5 Nm
Module width	fig. 1
Weight	85 g
Protection degree	IP 65

**Product references**

Types	Product reference	100k	1M
Potentiometer	SP-01/	✓	✓

“...” list resistance to complete product references.

**fig. 1. Dimensions (mm)**

## BZS DIN 17.5 mm

### Label

---

#### General data

Ambient temperature storage	-40 ... 85 °C
Ambient temperature operation	-25 ... 60 °C
Housing material	PC

---

#### Product references

Types	Product reference
Label	BZS DIN 17.5 mm



## HF-32

### Retaining clip | Steel

#### General data

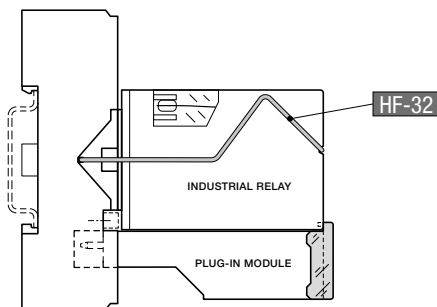
Ambient temperature storage	-40 ... 85 °C
Ambient temperature operation	-25 ... 60 °C
Module width	fig. 1
Weight	2 g
Housing material	Steel

#### Product references

Types	Product reference
Retaining clip	HF-32



fig. 1. Dimensions (mm)





## HF-33

### Retaining clip | Steel

#### General data

Ambient temperature storage	-40 ... 85 °C
Ambient temperature operation	-25 ... 60 °C
Module width	fig. 1
Weight	2 g
Housing material	Steel

#### Product references

Types	Product reference
Retaining clip	HF-33

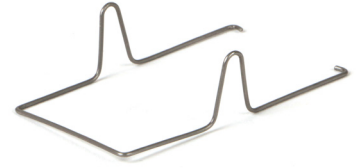
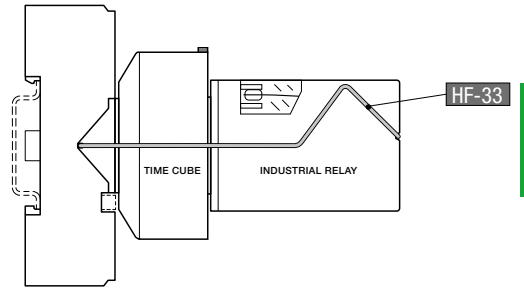


fig. 1. Dimensions (mm)



## HF-50

### Retaining clip | Steel

#### General data

Ambient temperature storage	-40 ... 85 °C
Ambient temperature operation	-25 ... 60 °C
Module width	fig. 1
Weight	2 g
Housing material	Steel

#### Product references

Types	Product reference
Retaining clip	HF-50

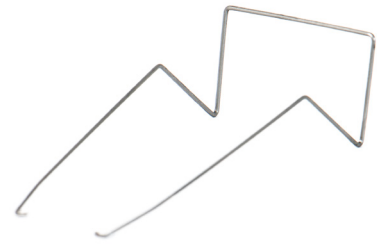
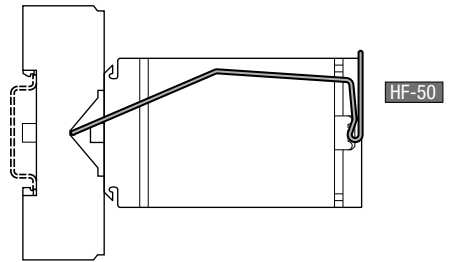


fig. 1. Dimensions (mm)



## FA-50

### Transparent front cover

#### General data

Ambient temperature storage	-40 ... 85 °C
Ambient temperature operation	-25 ... 60 °C
Module width	fig. 1
Weight	5 g
Housing material	PC

#### Product references

Types	Product reference
Transparent front cover	FA-50

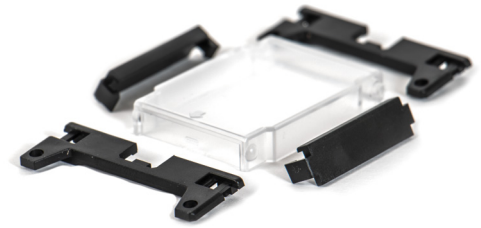
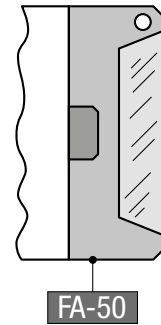


fig. 1. Dimensions (mm)



## FZ-50L

### Front panel mounting set | Socket S3-L | Retaining clip

#### General data

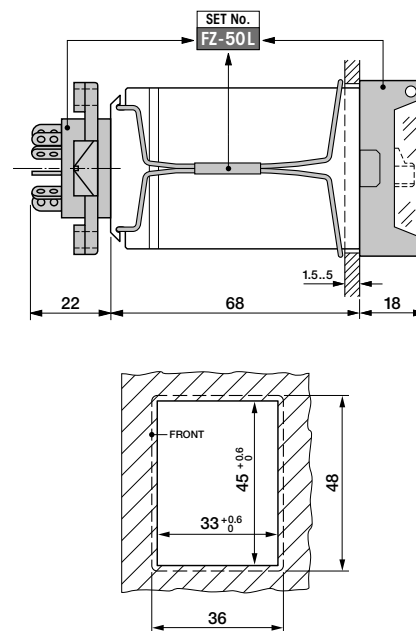
Ambient temperature storage	-40 ... 85 °C
Ambient temperature operation	-25 ... 60 °C
Module width	fig. 1
Weight	40 g
Housing material	PC

#### Product references

Types	Product reference
Front panel mounting set	FZ-50L



fig. 1. Dimensions (mm)



## FS-C

### Transparent front cover

#### General data

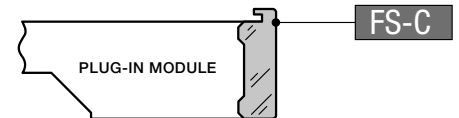
Ambient temperature storage	-40 ... 85 °C
Ambient temperature operation	-25 ... 60 °C
Module width	fig. 1
Weight	5 g

#### Product references

Types	Product reference
Transparent front cover, 5 pcs	FS-C/5 (BEUTEL/UNIT 5 STK/PCS)



fig. 1. Dimensions (mm)



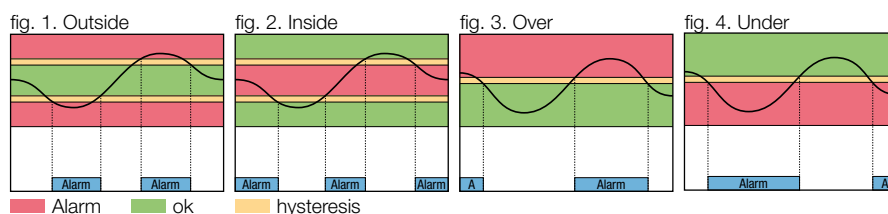


## 3 Monitoring & Measuring Devices

---

	Description	MRE-44S	MRM11	MRM11R	MRM32	MRM32R	MRU11	MRU32	MV53	SSU34	SSU31	SSU33L	MRI11	MRI32	TSR19	ESU-D2R	CT515R	CT524R
Monitoring	One phase voltage monitoring		●	●			●		●									
	Three phase voltage monitoring				●	●		●		●		●						
	Four channel voltage measuring	●																
	DC Voltage monitoring		●	●	●	●	●	●			●							●
	One phase current monitoring		●	●									●					
	Three phase current monitoring				●	●								●				
	Four channel current measuring	●																
	DC current monitoring		●	●	●	●							●	●			●	
	Phase failure				●	●		●		●	●	●						
	Phase sequence monitoring	●			●	●		●		●	●	●						
	Phase angle monitoring / measuring*	●			●	●		●		●		●						
	Differential voltage monitoring / measuring*	●									●	●						
	Neutral failure monitoring	●									●	●						
	Frequency monitoring / measuring*	●	●	●	●	●	●	●		●		●	●	●				
	Apparent power monitoring / measuring*	●	●	●	●	●												
	Active power monitoring / measuring*	●	●	●	●	●												
	Power factor monitoring / measuring*	●	●	●	●	●												
	Active energy measuring	●																
	THDI / THDU measuring	●																
	PTC monitoring														●			
Earth failure monitoring																●		
Functions	Threshold exceeded "over" fig. 3.	●	●	●	●	●	●	●	●	●		●	●	●	●		●	●
	Threshold undershot "under" fig. 4.	●	●	●	●	●	●	●	●	●	●	●	●	●	●	●	●	●
	Window function "inside" fig. 2.	●	●	●	●	●	●	●					●	●			●	●
	Window function "outside" fig.1.	●	●	●	●	●	●	●					●	●			●	●
	Alarm on-delay	●	●	●	●	●	●	●	●	●		●	●	●		●	●	●
	Alarm off-delay	●	●	●	●	●	●	●	●				●	●				
	Error storage function	●	●	●	●	●	●	●					●	●	●			
	Threshold selectable	●	●	●	●	●	●	●	●	●			●	●	●	●	●	●
	Threshold fixed										●	●			●			
	Power supply	Supply isolated from measuring circuit	●	●	●	●	●	●	●					●	●	●	●	
Supply from measure circuit									●	●	●	●					●	●
Mounting	DIN rail mounting	●	●	●	●	●	●	●	●	●			●	●		●		
	Housing according IEC/EN 43880 (electrical distribution mounting)	●	●	●	●	●	●	●	●					●	●			
	Plug-in (socket mounting)											●	●		●		●	●

\*Measuring: MRE-44S only





## 3.1 Energy Measuring Device

---

Application	Type	Page
<b>MRE Series</b>		
Energy measuring   4 voltage channels   4 current channels	MRE-44S	227

**Overview of features**

Due to its compact size and the use of interface technologies such as Modbus TCP, the MRE is perfectly suited for use in installations with multiple loads that require monitoring. To do so, one meter is connected to each corresponding power terminal or load to be measured.

Thanks to precise measurements and sophisticated calculation processes, the MRE records highly precise values for the electrical quantities, regardless of the type of load or the grid situation (e.g. power electronics providers). It can be used in all conventional systems operating at 16.7 Hz, 50 Hz and 60 Hz.

As a result of the high accuracy grade (current 0.1,

voltage 0.05) and numerous features that can be enabled – such as an expansion of the grid frequency range from 15 Hz to 400 Hz, a complete power quality analysis and the analysis of harmonics up to 50 kHz – it can be used flexibly for nearly all measuring tasks related to electrical infrastructure in industrial settings as well as office and administrative buildings.

- High-precision measuring, recording and archiving of all important electrical variables. For the identification of savings potentials and deviations in the context of energy management as per DIN EN ISO 50001.
- Monitoring of power quality (PQ) through complete PQ

analysis and comprehensive recording of harmonics up to 50 kHz. Monitoring of individual loads or entire grids allows for the identification of PQ problems or the monitoring of critical components.

- Continuous management through an integrated web browser for visualisation and parameterisation. Quick access to all relevant data at all times via mobile devices or laptops, and without additional software.
- Sophisticated data recording via the data logger allows for long-term analyses in high resolution and can also be used for statistical data analysis and fault prognosis.

Areas of application	Key areas	Conformity / Standards
<ul style="list-style-type: none"> <li>• Industry</li> <li>• Infrastructure</li> <li>• Testing devices</li> <li>• Service sector</li> <li>• Public sector</li> </ul>	<ul style="list-style-type: none"> <li>• Modular measurement for multiple outlets</li> <li>• Accuracy class 0.1 for electricity and 0.05 for voltage in accordance with IEC 61557-12</li> <li>• High flexibility and intuitive operation</li> <li>• Plug and Play</li> <li>• PQ functionality in accordance with IEC 61000-4-30</li> <li>• Flickermeter in accordance with IEC 61000-4-15</li> <li>• Records harmonics in current and voltage</li> <li>• Highly precise measurements in the additional frequency range</li> </ul>	<ul style="list-style-type: none"> <li>• IEC 61557-12</li> <li>• IEC 61000-4-15</li> <li>• IEC 61000-4-30</li> <li>• ISO 14025</li> </ul>

**Discovery Tool**

The MRE is configured with a preset IP address upon delivery. With the free discovery tool, the device can easily be located from any computer in all networks. No special knowledge is required, nor is it necessary to modify the communication parameters of your own computer. Whether you are using a fixed IP address or DHCP, the discovery tool allows the basic settings of the MRE's communication interface to be configured as required.

**Web server**

The integrated web server provides a clear interface for configuring the MRE for each individual application. In just a few clicks, the MRE can be configured for the circuit to be measured. The integrated search function allows the desired parameters to be found quickly. Important variables can be added to a favourites list and displayed graphically. Two access levels protect the device from unauthorised access and ensure a high degree of security.

**Flexible**

- Simplified wiring with PoE
- Measurements close to load (transformer and meter)
- Data logging and customised dashboards via optional data logger
- Full PQ functionality and individual protective functions can be optionally integrated
- Transformers of various accuracy grades available as accessories

**MRE-44S****Energy measuring | 4 voltage channels | 4 current channels****Power supply**

Nominal voltage	24 V DC
Operating voltage range	18 ... 30 V DC
Power consumption AC/DC	- / 5 W

**Measuring circuit**

Measured parameters	U, I, f, P, Q, S, E, THDU, THDI
Number of voltage measurement inputs	4
Rated AC voltage L-N / L-L	230 V AC / 400 V AC
AC voltage measurement range L-N / L-L	5 ... 276 V AC / 5 ... 480 V AC
Number of current measurement inputs	4
Rated measurement current	5 A
Measurement current range	0.005 ... 6 A
Max. current	60 A, 1 s
Rated base frequency	30 ... 65 Hz
Harmonic frequency	< 10 kHz
Sampling frequency per measurement channel	20 kS / s
Bandwidth per measurement channel	10 kHz
Accuracy class voltage [U]	0.05
Accuracy class current [I]	0.5
Accuracy class frequency [f]	0.02
Accuracy class power factor [cosPhi]	0.5
Accuracy class active power [P]	0.1
Accuracy class active energy [E]	0.2
Accuracy class reactive power [Q]	1
Accuracy class apparent power [S]	0.2
THDU / THDI	1 / 1

**Inputs**

Number of analogue / digital inputs	3
Nominal voltage digital inputs	24 V DC
High level threshold digital Inputs	11.5 V DC
Nominal range analogue inputs	0 ... 10 V
Resolution of analogue inputs	12 Bit

**Outputs**

Number of transistor outputs	1
Rated voltage	60 V DC
Rated current	350 mA

**Interfaces**

Hardware interfaces	Ethernet, RS 485
Protocols	Modbus TCP, Modbus RTU
Transfer rate	100 Mbit, 19200 Baud

**Insulation**

Rated insulation voltage	300 V
Pollution degree	2
Overvoltage category	III

**General data**

Ambient temperature storage	-40 ... 85 °C
Ambient temperature operation	-25 ... 55 °C
Conductor cross section	2.5 mm <sup>2</sup>
Nominal screw torque	0.5 Nm
Module width	fig. 2
Weight	120 g
Protection degree	IP 20
Housing material	PC

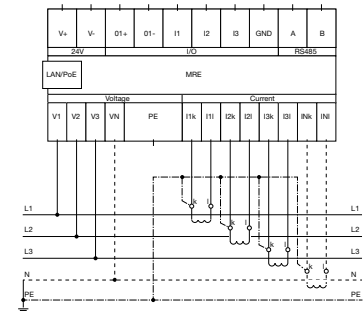
**Product references**

Types	Product reference	24
Energy measuring	MRE-44S/DC...V	✓

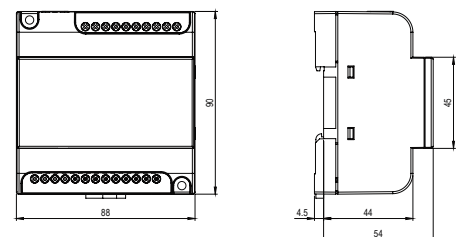
"..." list control circuit voltage to complete product references.

Other voltages on request. Please contact support@comatreleco.com.

Официальный дистрибьютор ComatReleco в России / ООО "ПОЛИГОН" / (812) 3254220 / www.poligon.info

**fig. 1. Wiring diagram**

Connection diagrams for other networks in the technical data sheet.

**fig. 2. Dimensions (mm)****Standards and approvals**

Standards	IEC/EN 61000-6-2:2005, IEC/EN 61000-6-3:2007, IEC/EN 61557-12, IEC/EN 61000-4-15, IEC/EN 61000-4-30
-----------	--

Approvals



## 3.2 Multifunction Monitoring

---

Application	Type	Page
<b>MRM Series</b>		
Single phase multifunction monitoring   12 ... 48 V UC   110 ... 240 V UC	MRM11, MRM11R	230
Three phase multifunction monitoring   12 ... 48 V UC   110 ... 240 V UC	MRM32, MRM32R	231

### 3.2 Multifunction Monitoring

## MRM11, MRM11R

### Single phase multifunction monitoring | 12 ... 48 V UC | 110 ... 240 V UC

#### Power supply

Nominal voltage	12 ... 48 V UC	110 ... 240 V UC
Operating voltage range	10 ... 60 V	85 ... 250 V
Power consumption AC/DC	3.2 VA / 1.6 W	2.6 VA / 1.5 W
Rated frequency	16 ... 63 Hz	

#### Measuring circuit

Measured parameters	U, I, P, S, f, Cosφ
Min. setting step, resolution	0.1 V / 0.1 A / 1 W / 1 VA / 0.1 Hz / 0.01
Monitoring functions	Under, over, inside, outside
Number of voltage measurement inputs	1
Rated AC voltage L-N / L-L	230 V / -
AC voltage measurement range L-N / L-L	0.1 ... 480 V
Rated DC voltage U+-U-	300 V
DC voltage measurement range U+-U-	±0.1 ... 690 V
Undervoltage setting range	0.1 ... 480 V AC / ±0.1 ... 690 V DC
Overvoltage setting range	0.1 ... 480 V AC / ±0.1 ... 690 V DC
Number of current measurement inputs	1
Rated measurement current	5 A
Measurement current range	0.1 ... 6 A
Undercurrent setting range	0.1 ... 5 A
Overcurrent setting range	0.1 ... 5 A
Rated base frequency	15 ... 150 Hz
Alarm delay	0.5 ... 999.9 s
Alarm reset delay	0.5 ... 999.9 s

#### Main circuit

Number of contacts	1 CO
Contact Material	AgNi
Rated voltage	250 V
Rated current	6 A
Minimum load	10 mA, 10 V
Inrush current	10 A, 10 ms
Rated load DC	fig. 2
Rated load AC-1	1500 VA
Mechanical endurance (cycles)	3 x 10 <sup>7</sup>
Electrical endurance at rated load AC-1 (cycles)	fig. 3

#### Insulation

Rated test voltage measuring / measuring circuit	1.5 kV rms / 1 min
Rated test voltage measuring circuit / power supply	2 kV rms / 1 min
Rated test voltage measuring circuit / main circuit	2 kV rms / 1 min
Rated test voltage main circuit / power supply	2 kV rms / 1 min
Rated test voltage open contact	1 kV rms / 1 min
Pollution degree	2
Overvoltage category	III

#### General data

Ambient temperature storage	-40 ... 85 °C
Ambient temperature operation	-40 ... 60 °C
Ambient temperature operation railway version	-40 ... 70 °C
Conductor cross section	2.5 mm <sup>2</sup>
Nominal screw torque	0.6 Nm
Module width	fig. 4
Weight	107 g
Protection degree	IP 20
Housing material	PC

#### Product references

Types	Product reference	12-48	110-240
Single phase monitoring	MRM11/UC...V	✓	✓
Single phase monitoring, railway version	MRM11R/UC...V	✓	✓

"..." list control circuit voltage to complete product references.

Other voltages on request. Please contact support@comatreleco.com.



**comat**  
**RELECO**



fig. 1. Wiring diagram

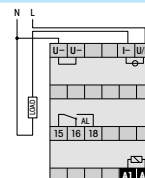


fig. 2. DC load limit curve

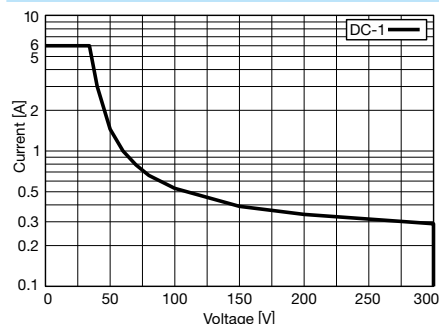


fig. 3. AC voltage endurance

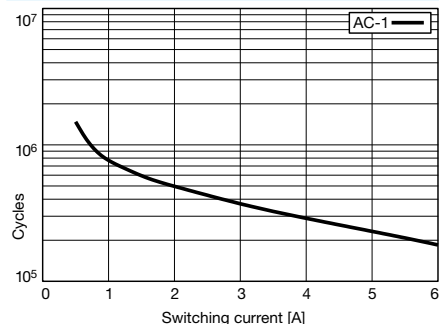
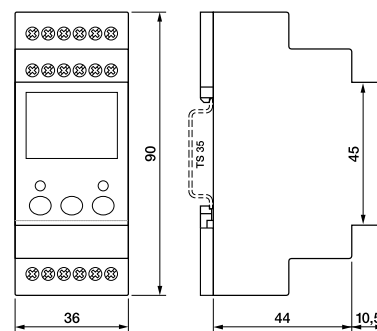


fig. 4. Dimensions (mm)



#### Standards and approvals

Standards IEC/EN 60947, IEC/EN 60730, IEC/EN 50155, IEC/EN 45545, IEC/EN 43880

Approvals

### 3.2 Multifunction Monitoring

## MRM32, MRM32R

### Three phase multifunction monitoring | 12 ... 48 V UC | 110 ... 240 V UC

#### Power supply

Nominal voltage	12 ... 48 V UC	110 ... 240 V UC
Operating voltage range	10 ... 60 V	85 ... 250 V
Power consumption AC/DC	3.2 VA / 1.6 W	2.6 VA / 1.5 W
Rated frequency	16 ... 63 Hz	

#### Measuring circuit

Measured parameters	U, I, P, S, f, Cosφ, ΔPhi, phase sequence
Min. setting step, resolution	0.1 V / 0.1 A / 1 W / 1 VA / 0.1 Hz / 0.01 / 1°
Monitoring functions	Under, over, inside, outside, phase sequence, phase failure
Number of voltage measurement inputs	3
Rated AC voltage L-N / L-L	230 V / 400 V
AC voltage measurement range L-N / L-L	0.1 ... 480 V
Rated DC voltage U+-U-	300 V
DC voltage measurement range U+-U-	±0.1 ... 690 V
Undervoltage setting range	0.1 ... 480 V AC / ±0.1 ... 690 V DC
Overvoltage setting range	0.1 ... 480 V AC / ±0.1 ... 690 V DC
Number of current measurement inputs	3
Rated measurement current	5 A
Measurement current range	0.1 ... 6 A
Undercurrent setting range	0.1 ... 5 A
Overcurrent setting range	0.1 ... 5 A
Rated base frequency	15 ... 150 Hz
Alarm delay	0.5 ... 999.9 s
Alarm reset delay	0.5 ... 999.9 s

#### Main circuit

Number of contacts	2 CO
Contact Material	AgNi
Rated voltage	250 V
Rated current	6 A
Minimum load	10 mA, 10 V
Inrush current	10 A, 10 ms
Rated load DC	fig. 2
Rated load AC-1	1500 VA
Mechanical endurance (cycles)	3 x 10 <sup>7</sup>
Electrical endurance at rated load AC-1 (cycles)	fig. 3

#### Insulation

Rated test voltage measuring / measuring circuit	1.5 kV rms / 1 min
Rated test voltage measuring circuit / power supply	2 kV rms / 1 min
Rated test voltage measuring circuit / main circuit	2 kV rms / 1 min
Rated test voltage main circuit / power supply	2 kV rms / 1 min
Rated test voltage main / main circuit	1.5 kV rms / 1 min
Rated test voltage open contact	1 kV rms / 1 min
Pollution degree	2
Overvoltage category	III

#### General data

Ambient temperature storage	-40 ... 85 °C
Ambient temperature operation	-40 ... 60 °C
Ambient temperature operation railway version	-40 ... 70 °C
Conductor cross section	2.5 mm <sup>2</sup>
Nominal screw torque	0.6 Nm
Module width	fig. 4
Weight	125 g
Protection degree	IP 20
Housing material	PC

#### Product references

Types	Product reference	12-48	110-240
Three phase monitoring	MRM32/UC...V	✓	✓
Three phase monitoring, railway version	MRM32R/UC...V	✓	✓



fig. 1. Wiring diagram

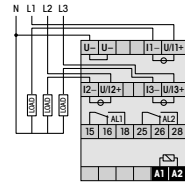


fig. 2. DC load limit curve

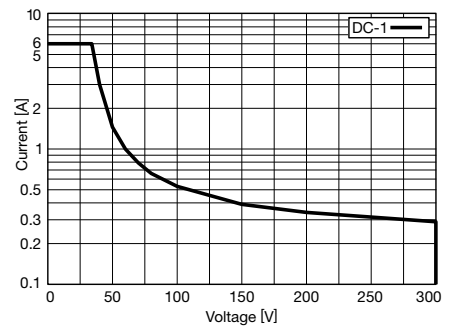


fig. 3. AC voltage endurance

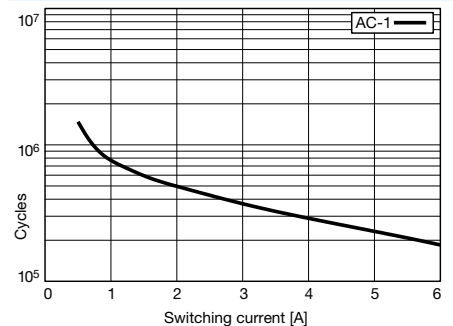
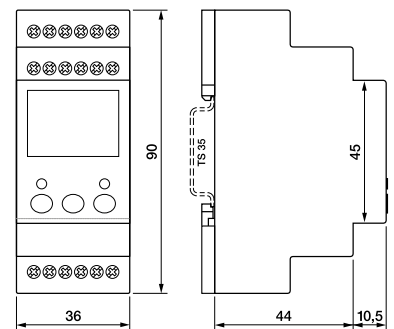


fig. 4. Dimensions (mm)



#### Standards and approvals

Standards IEC/EN 60947, IEC/EN 60730, IEC/EN 50155, IEC/EN 45545, IEC/EN 43880

Approvals

"..." list control circuit voltage to complete product references.

Other voltages on request. Please contact support@comatreleco.com.

Официальный дистрибьютор ComatReleco в России / ООО "ПОЛИГОН" / (812) 3254220 / www.poligon.info





## 3.3 Voltage Monitoring

---

Application	Type	Page
<b>MRU Series</b>		
Single phase voltage monitoring   12 ... 48 V UC   110 ... 240 V UC	MRU11	234
Three phase voltage monitoring   12 ... 48 V UC   110 ... 240 V UC	MRU32	235
<b>MV Series</b>		
Single phase voltage monitoring   115 V AC   230 V AC	MV53	236
<b>SSU Series</b>		
Three phase + N voltage monitoring   400 V AC	SSU34	237

# MRU11

## Single phase voltage monitoring | 12 ... 48 V UC | 110 ... 240 V UC

### Power supply

Nominal voltage	12 ... 48 V UC	110 ... 240 V UC
Operating voltage range	10 ... 60 V	85 ... 250 V
Power consumption AC/DC	3.2 VA / 1.6 W	2.6 VA / 1.5 W
Rated frequency	16 ... 63 Hz	

### Measuring circuit

Measured parameters	U, f
Min. setting step, resolution	0.1 V / 0.1 Hz
Monitoring functions	Under, over, inside, outside
Number of voltage measurement inputs	1
Rated AC voltage L-N / L-L	230 V / -
AC voltage measurement range L-N / L-L	0.1 ... 480 V
Rated DC voltage U+-U-	300 V
DC voltage measurement range U+-U-	±0.1 ... 690 V
Undervoltage setting range	0.1 ... 480 V AC / ±0.1 ... 690 V DC
Overvoltage setting range	0.1 ... 480 V AC / ±0.1 ... 690 V DC
Alarm delay	0.5 ... 999.9 s
Alarm reset delay	0.5 ... 999.9 s

### Main circuit

Number of contacts	1 CO
Contact Material	AgNi
Rated voltage	250 V
Rated current	6 A
Minimum load	10 mA, 10 V
Inrush current	10 A, 10 ms
Rated load DC	fig. 2
Rated load AC-1	1500 VA
Mechanical endurance (cycles)	3 x 10 <sup>7</sup>
Electrical endurance at rated load AC-1 (cycles)	fig. 3

### Insulation

Rated test voltage measuring / measuring circuit	1.5 kV rms / 1 min
Rated test voltage measuring circuit / power supply	2 kV rms / 1 min
Rated test voltage measuring circuit / main circuit	2 kV rms / 1 min
Rated test voltage main circuit / power supply	2 kV rms / 1 min
Rated test voltage open contact	1 kV rms / 1 min
Pollution degree	2
Overvoltage category	III

### General data

Ambient temperature storage	-40 ... 85 °C
Ambient temperature operation	-40 ... 60 °C
Conductor cross section	2.5 mm <sup>2</sup>
Nominal screw torque	0.6 Nm
Module width	fig. 4
Weight	107 g
Protection degree	IP 20
Housing material	PC

### Product references

Types	Product reference	12-48	110-240
Single phase monitoring	MRU11/UC...V	✓	✓

"..." list control circuit voltage to complete product references.  
Other voltages on request. Please contact support@comatreleco.com.



fig. 1. Wiring diagram

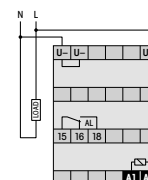


fig. 2. DC load limit curve

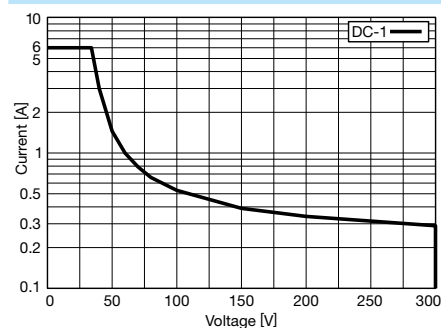


fig. 3. AC voltage endurance

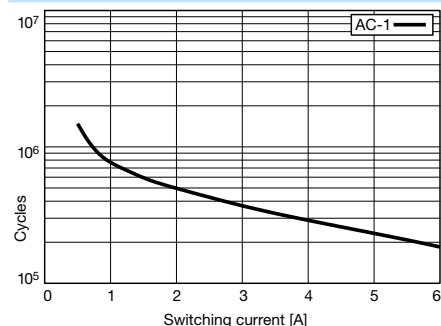
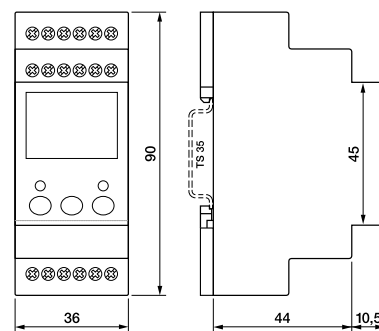


fig. 4. Dimensions (mm)



### Standards and approvals

Standards IEC/EN 60947, IEC/EN 60730, IEC/EN 43880

Approvals

**MRU32**

**Three phase voltage monitoring | 12 ... 48 V UC | 110 ... 240 V UC**

**Power supply**

Nominal voltage	12 ... 48 V UC	110 ... 240 V UC
Operating voltage range	10 ... 60 V	85 ... 250 V
Power consumption AC/DC	3.2 VA / 1.6 W	2.6 VA / 1.5 W
Rated frequency	16 ... 63 Hz	

**Measuring circuit**

Measured parameters	U, f, ΔPhi, phase sequence
Min. setting step, resolution	0.1 V / 0.1 Hz / 0.01
Monitoring functions	Under, over, inside, outside, phase sequence, phase failure
Number of voltage measurement inputs	3
Rated AC voltage L-N / L-L	230 V / 400 V
AC voltage measurement range L-N / L-L	0.1 ... 480 V
Rated DC voltage U+-U-	300 V
DC voltage measurement range U+-U-	±0.1 ... 690 V
Undervoltage setting range	0.1 ... 480 V AC / ±0.1 ... 690 V DC
Overvoltage setting range	0.1 ... 480 V AC / ±0.1 ... 690 V DC
Alarm delay	0.5 ... 999.9 s
Alarm reset delay	0.5 ... 999.9 s

**Main circuit**

Number of contacts	2 CO
Contact Material	AgNi
Rated voltage	250 V
Rated current	6 A
Minimum load	10 mA, 10 V
Inrush current	10 A, 10 ms
Rated load DC	fig. 2
Rated load AC-1	1500 VA
Mechanical endurance (cycles)	3 x 10 <sup>7</sup>
Electrical endurance at rated load AC-1 (cycles)	fig. 3

**Insulation**

Rated test voltage measuring / measuring circuit	1.5 kV rms / 1 min
Rated test voltage measuring circuit / power supply	2 kV rms / 1 min
Rated test voltage measuring circuit / main circuit	2 kV rms / 1 min
Rated test voltage main circuit / power supply	2 kV rms / 1 min
Rated test voltage main / main circuit	1.5 kV rms / 1 min
Rated test voltage open contact	1 kV rms / 1 min
Pollution degree	2
Overvoltage category	III

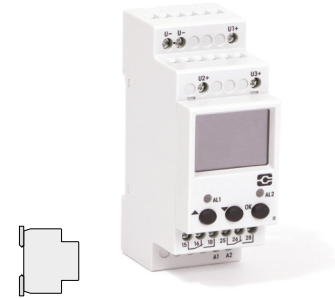
**General data**

Ambient temperature storage	-40 ... 85 °C
Ambient temperature operation	-40 ... 60 °C
Conductor cross section	2.5 mm <sup>2</sup>
Nominal screw torque	0.6 Nm
Module width	fig. 4
Weight	125 g
Protection degree	IP 20
Housing material	PC

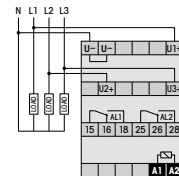
**Product references**

Types	Product reference	12-48	110-240
Three phase monitoring	MRU32/UC...V	✓	✓

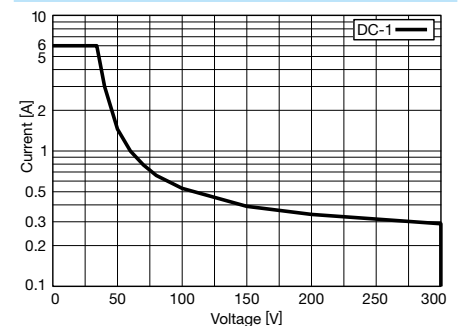
"..." list control circuit voltage to complete product references.  
Other voltages on request. Please contact support@comatreleco.com.



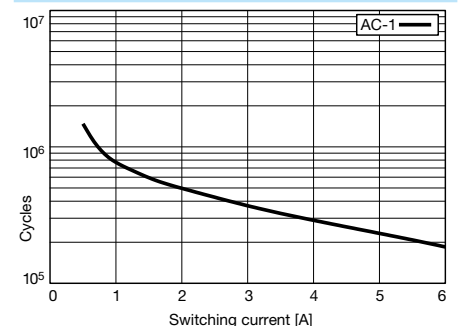
**fig. 1. Wiring diagram**



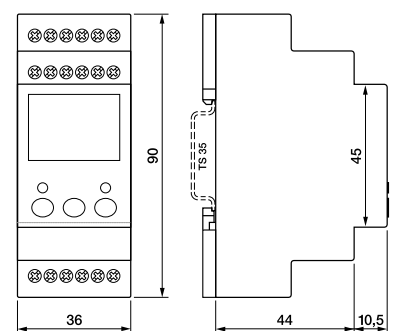
**fig. 2. DC load limit curve**



**fig. 3. AC voltage endurance**



**fig. 4. Dimensions (mm)**



**Standards and approvals**

Standards IEC/EN 60947, IEC/EN 60730, IEC/EN 43880

Approvals

**MV53**

**Single phase voltage monitoring | 115 V AC | 230 V AC**

**Power supply**

Nominal voltage	230 V AC
Operating voltage range	149 ... 270 V
Power consumption AC/DC	2.3 VA / -
Rated frequency	45 ... 65 Hz

**Measuring circuit**

Measured parameters	U
Monitoring functions	Under, over
Number of voltage measurement inputs	1 (A1 / A2)
Rated AC voltage L-N / L-L	230 V / -
AC voltage measurement range L-N / L-L	149 ... 270 V
Undervoltage setting range	149 ... 218 V
Overvoltage setting range	236 ... 270 V
Rated base frequency	45 ... 65 Hz

**Main circuit**

Number of contacts	1 CO
Contact Material	AgNi
Rated voltage	250 V
Rated current	6 A
Minimum load	10 mA, 5 V
Inrush current	20 A, 20 ms
Rated load DC	fig. 2
Rated load AC-1	1500 VA
Mechanical endurance (cycles)	$2 \times 10^7$
Electrical endurance at rated load AC-1 (cycles)	fig. 3

**Insulation**

Rated test voltage main circuit / power supply	2 kV rms / 1 min
Rated test voltage open contact	1 kV rms / 1 min
Pollution degree	2
Overvoltage category	III

**General data**

Ambient temperature storage	-40 ... 85 °C
Ambient temperature operation	-40 ... 60 °C
Conductor cross section	2.5 mm <sup>2</sup> , 2 x 1.5 mm <sup>2</sup>
Nominal screw torque	0.8 Nm
Module width	fig. 4
Weight	80 g
Protection degree	IP 20
Housing material	PC

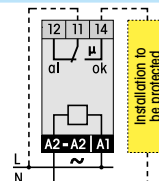
**Product references**

Types	Product reference	230
Single phase monitoring	MV53/AC...V	✓

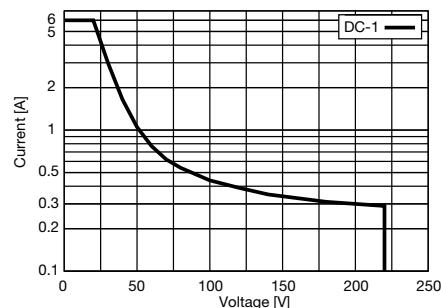
"..." list control circuit voltage to complete product references.  
Other voltages on request. Please contact support@comatreleco.com.



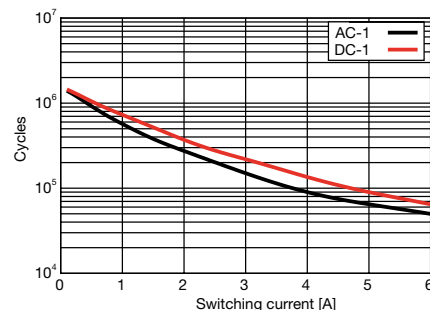
**fig. 1. Wiring diagram**



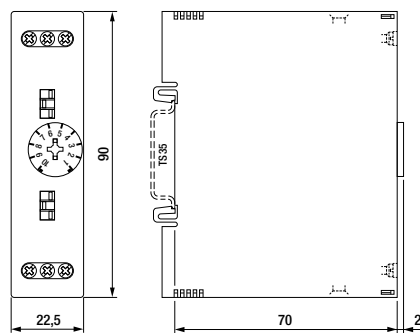
**fig. 2. DC load limit curve**



**fig. 3. AC voltage endurance**



**fig. 4. Dimensions (mm)**



**Standards and approvals**

Standards IEC/EN 60065

Approvals

# SSU34

## Three phase + N voltage monitoring | 400 V AC

### Power supply

Nominal voltage	400 V AC
Operating voltage range	240 ... 495 V
Power consumption AC/DC	1.5 VA
Rated frequency	50 Hz

### Measuring circuit

Measured parameters	U, ΔPhi, Δf
Monitoring functions	Under, over, phase failure, phase sequence
Number of voltage measurement inputs	4 (L1 / L2 / L3 / N)
Rated AC voltage L-N / L-L	230 V / 400 V
AC voltage measurement range L-N / L-L	160 ... 275 V / 280 ... 480 V
Undervoltage setting range	160 ... 225 V / 280 ... 390 V
Overvoltage setting range	235 ... 275 V / 410 ... 480 V
Voltage difference setting range L-L	20 ... 100 V      35 ... 173 V
Rated base frequency	50 Hz
Frequency difference setting range L-L	3 ... 15 Hz
Phase angle difference setting range L-L	3 ... 15°
Alarm delay	0.2 ... 5 s

### Main circuit

Number of contacts	2 CO
Contact Material	AgNi
Rated voltage	250 V
Rated current	5 A
Minimum load	10 mA, 12 V
Inrush current	15 A, 20 ms
Rated load DC	fig. 2
Rated load AC-1	1250 VA
Mechanical endurance (cycles)	5 x 10 <sup>6</sup>
Electrical endurance at rated load AC-1 (cycles)	fig. 3

### Insulation

Rated test voltage measuring / measuring circuit	3 kV rms / 1 min
Rated test voltage measuring circuit / main circuit	3 kV rms / 1 min
Rated test voltage open contact	1 kV rms / 1 min
Pollution degree	2
Overvoltage category	III

### General data

Ambient temperature storage	-40 ... 85 °C
Ambient temperature operation	-10 ... 60 °C
Conductor cross section	2.5 mm <sup>2</sup> , 2 x 1.5 mm <sup>2</sup>
Nominal screw torque	0.5 Nm
Module width	fig. 4
Weight	350 g
Protection degree	IP 20
Housing material	PC

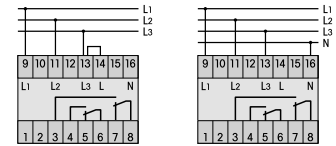
### Product references

Types	Product reference	400
Three phase monitoring	SSU34/AC...V	✓

"..." list control circuit voltage to complete product references.  
Other voltages on request. Please contact support@comatreleco.com.



fig. 1. Wiring diagram



DO NOT CONNECT AT THE SAME TIME:  
Neutral conductor N and bridge L3-!!

fig. 2. DC load limit curve

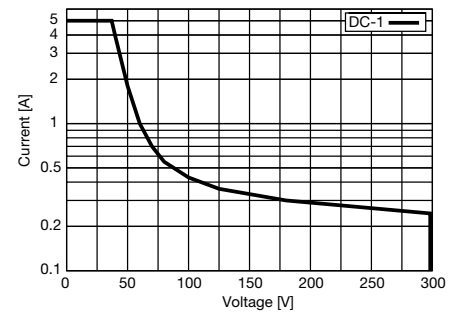


fig. 3. AC voltage endurance

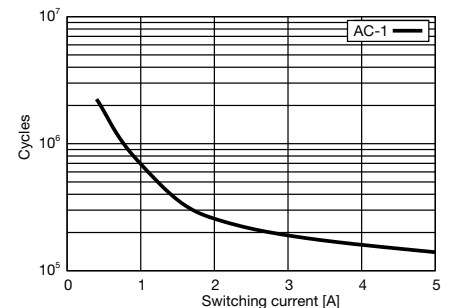
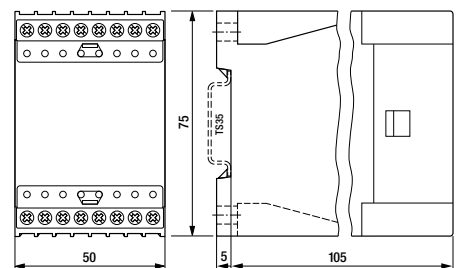


fig. 4. Dimensions (mm)



### Standards and approvals

Standards IEC/EN 60947

Approvals



## 3.4 Voltage Monitoring - pluggable

---

Application	Type	Page
<b>SSU Series</b>		
Phase sequence monitoring   400 V AC	SSU31	240
Three phase + N voltage monitoring   230 V AC   400 V AC	SSU33L	241

**SSU31****Phase sequence monitoring | 400 V AC****Power supply**

Nominal voltage	400 V AC
Operating voltage range	320 ... 480 V
Power consumption AC/DC	10 VA
Rated frequency	45 ... 65 Hz

**Measuring circuit**

Measured parameters	U
Monitoring functions	Under, phase failure, phase sequence
Number of voltage measurement inputs	3 (L1 / L2 / L3)
Rated AC voltage L-N / L-L	- / 400 V
AC voltage measurement range L-N / L-L	320 ... 400 V
Undervoltage setting range	≤ 320 V
Rated base frequency	45 ... 65 Hz

**Main circuit**

Number of contacts	1 CO
Contact Material	⚡ AgNi
Rated voltage	250 V
Rated current	6 A
Minimum load	10 mA, 5 V
Inrush current	15 A, 20 ms
Rated load DC	fig. 2
Rated load AC-1	1500 VA
Mechanical endurance (cycles)	3 x 10 <sup>7</sup>
Electrical endurance at rated load AC-1 (cycles)	fig. 3

**Insulation**

Rated test voltage measuring / measuring circuit	2 kV rms / 1 min
Rated test voltage measuring circuit / main circuit	2 kV rms / 1 min
Rated test voltage open contact	1 kV rms / 1 min
Pollution degree	2
Overvoltage category	III

**General data**

Ambient temperature storage	-40 ... 85 °C
Ambient temperature operation	-25 ... 60 °C
Module width	fig. 4
Weight	300 g
Protection degree	IP 20
Housing material	PC

**Product references**

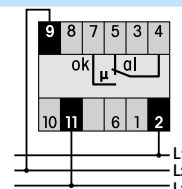
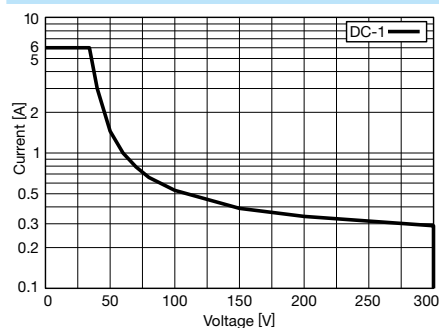
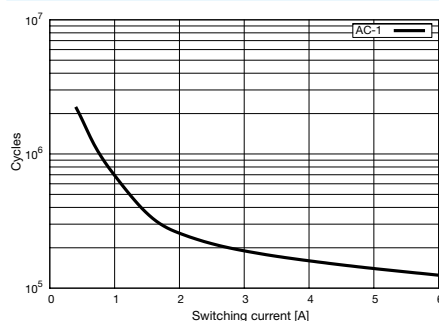
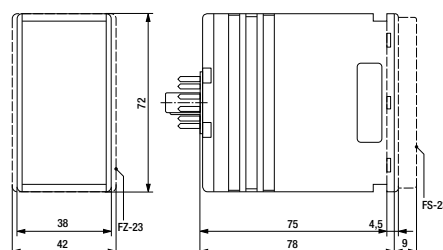
Types	Product reference	400
Three phase monitoring	SSU31/AC...V	✓

"..." list control circuit voltage to complete product references.

Other voltages on request. Please contact [support@comatreleco.com](mailto:support@comatreleco.com).

**Accessories**

Socket	S3-M
Retaining clip	HF-24
Transparent front cover	FS-23
Front panel mounting set	FZ-23

**fig. 1. Wiring diagram****fig. 2. DC load limit curve****fig. 3. AC voltage endurance****fig. 4. Dimensions (mm)****Standards and approvals**

Standards IEC/EN 60947

Approvals





# SSU33L

## Three phase + N voltage monitoring | 230 V AC | 400 V AC

### Power supply

Nominal voltage	230 V AC	400 V AC
Operating voltage range	160 ... 275 V	280 ... 480 V
Power consumption AC/DC	3 VA	
Rated frequency	50 Hz	

### Measuring circuit

Measured parameters	U, ΔPhi, Δf	
Monitoring functions	Under, over, phase failure, phase sequence	
Number of voltage measurement inputs	4 (L1 / L2 / L3 / N)	3 (L1 / L2 / L3)
Rated AC voltage L-N / L-L	230 V / 400 V	- / 400 V
AC voltage measurement range L-N / L-L	160 ... 275 V	280 ... 480 V
Undervoltage setting range	≤ 160 V	≤ 280 V
Overvoltage setting range	≥ 275 V	≥ 480 V
Voltage difference setting range L-L	20 ... 100 V	35 ... 173 V
Rated base frequency	50 Hz	
Frequency difference setting range L-L	3 ... 15 Hz	
Phase angle difference setting range L-L	3 ... 15°	
Alarm delay	0.2 ... 5 s	

### Main circuit

Number of contacts	1 CO
Contact Material	AgNi
Rated voltage	250 V
Rated current	6 A
Minimum load	10 mA, 5 V
Inrush current	15 A, 20 ms
Rated load DC	fig. 2
Rated load AC-1	1500 VA
Mechanical endurance (cycles)	3 x 10 <sup>7</sup>
Electrical endurance at rated load AC-1 (cycles)	fig. 3

### Insulation

Rated test voltage measuring / measuring circuit	2 kV rms / 1 min
Rated test voltage measuring circuit / main circuit	2 kV rms / 1 min
Rated test voltage open contact	1 kV rms / 1 min
Pollution degree	2
Overvoltage category	III

### General data

Ambient temperature storage	-40 ... 85 °C
Ambient temperature operation	-25 ... 60 °C
Module width	fig. 4
Weight	300 g
Protection degree	IP 20
Housing material	PC

### Product references

Types	Product reference	230	400
Three phase monitoring	SSU33L/AC...V	✓	
Three phase monitoring + N	SSU33L/AC...V		✓

"..." list control circuit voltage to complete product references.  
Other voltages on request. Please contact support@comatreleco.com.

### Accessories

Socket	S3-M
Retaining clip	HF-24
Transparent front cover	FS-23
Front panel mounting set	FZ-23



fig. 1. Wiring diagram

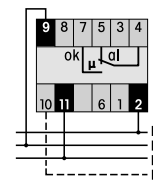


fig. 2. DC load limit curve

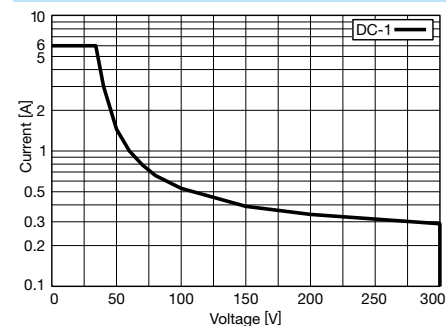


fig. 3. AC voltage endurance

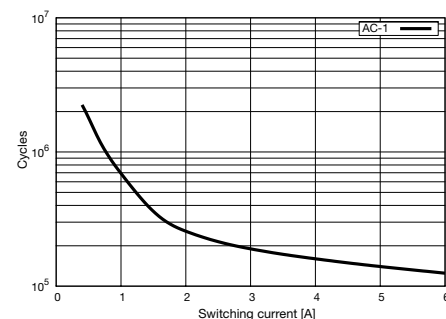
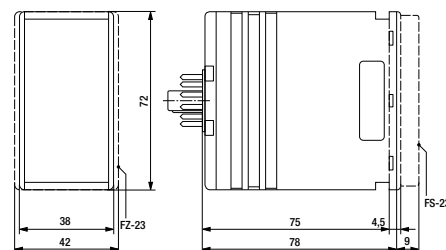


fig. 4. Dimensions (mm)



### Standards and approvals

Standards IEC/EN 60947

Approvals



## 3.5 Current Monitoring

---

Application	Type	Page
<b>MRI Series</b>		
Single phase current monitoring   12 ... 48 V UC   110 ... 240 V UC	MRI11	244
Three phase current monitoring   12 ... 48 V UC   110 ... 240 V UC	MRI32	245

**MRI11**

**Single phase current monitoring | 12 ... 48 V UC | 110 ... 240 V UC**

**Power supply**

Nominal voltage	12 ... 48 V UC	110 ... 240 V UC
Operating voltage range	10 ... 60 V	85 ... 250 V
Power consumption AC/DC	3.2 VA / 1.6 W	2.6 VA / 1.5 W
Rated frequency	16 ... 63 Hz	

**Measuring circuit**

Measured parameters	I, f
Min. setting step, resolution	0.1 A / 0.1 Hz
Monitoring functions	Under, over, inside, outside
Number of current measurement inputs	1
Rated measurement current	5 A
Measurement current range	0.1 ... 6 A
Undercurrent setting range	0.1 ... 5 A
Overcurrent setting range	0.1 ... 5 A
Rated base frequency	15 ... 150 Hz
Alarm delay	0.5 ... 999.9 s
Alarm reset delay	0.5 ... 999.9 s

**Main circuit**

Number of contacts	1 CO
Contact Material	AgNi
Rated voltage	250 V
Rated current	6 A
Minimum load	10 mA, 10 V
Inrush current	10 A, 10 ms
Rated load DC	fig. 2
Rated load AC-1	1500 VA
Mechanical endurance (cycles)	3 x 10 <sup>7</sup>
Electrical endurance at rated load AC-1 (cycles)	fig. 3

**Insulation**

Rated test voltage measuring / measuring circuit	1.5 kV rms / 1 min
Rated test voltage measuring circuit / power supply	2 kV rms / 1 min
Rated test voltage measuring circuit / main circuit	2 kV rms / 1 min
Rated test voltage main circuit / power supply	2 kV rms / 1 min
Rated test voltage open contact	1 kV rms / 1 min
Pollution degree	2
Overvoltage category	III

**General data**

Ambient temperature storage	-40 ... 85 °C
Ambient temperature operation	-40 ... 60 °C
Conductor cross section	2.5 mm <sup>2</sup>
Nominal screw torque	0.6 Nm
Module width	fig. 4
Weight	107 g
Protection degree	IP 20
Housing material	PC

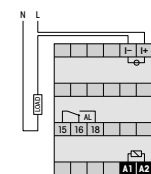
**Product references**

Types	Product reference	12-48	110-240
Single phase monitoring	MRI11/UC...V	✓	✓

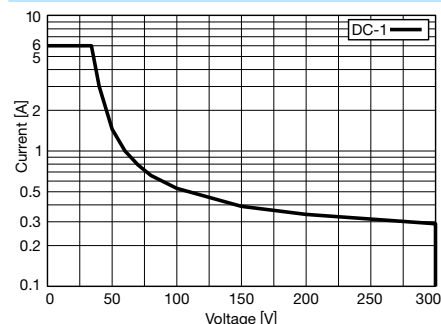
"..." list control circuit voltage to complete product references.  
Other voltages on request. Please contact support@comatreleco.com.



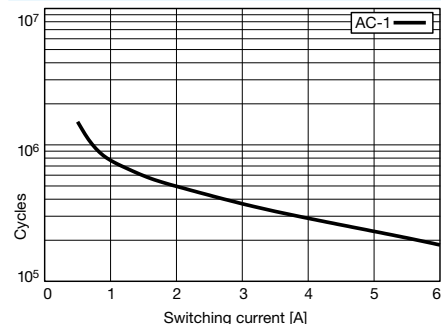
**fig. 1. Wiring diagram**



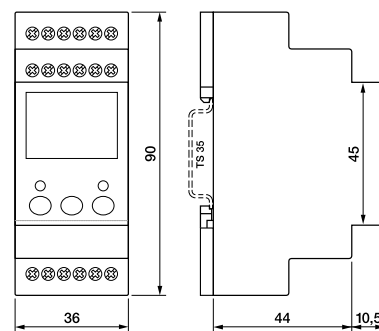
**fig. 2. DC load limit curve**



**fig. 3. AC voltage endurance**



**fig. 4. Dimensions (mm)**



**Standards and approvals**

Standards IEC/EN 60947, IEC/EN 60730, IEC/EN 43880

Approvals

**MRI32**

**Three phase current monitoring | 12 ... 48 V UC | 110 ... 240 V UC**

**Power supply**

Nominal voltage	12 ... 48 V UC	110 ... 240 V UC
Operating voltage range	10 ... 60 V	85 ... 250 V
Power consumption AC/DC	3.2 VA / 1.6 W	2.6 VA / 1.5 W
Rated frequency	16 ... 63 Hz	

**Measuring circuit**

Measured parameters	I, f
Min. setting step, resolution	0.1 A / 0.1 Hz
Monitoring functions	Under, over, inside, outside
Number of current measurement inputs	3
Rated measurement current	5 A
Measurement current range	0.1 ... 6 A
Undercurrent setting range	0.1 ... 5 A
Overcurrent setting range	0.1 ... 5 A
Rated base frequency	15 ... 150 Hz
Alarm delay	0.5 ... 999.9 s
Alarm reset delay	0.5 ... 999.9 s

**Main circuit**

Number of contacts	2 CO
Contact Material	AgNi
Rated voltage	250 V
Rated current	6 A
Minimum load	10 mA, 10 V
Inrush current	10 A, 10 ms
Rated load DC	fig. 2
Rated load AC-1	1500 VA
Mechanical endurance (cycles)	3 x 10 <sup>7</sup>
Electrical endurance at rated load AC-1 (cycles)	fig. 3

**Insulation**

Rated test voltage measuring / measuring circuit	1.5 kV rms / 1 min
Rated test voltage measuring circuit / power supply	2 kV rms / 1 min
Rated test voltage measuring circuit / main circuit	2 kV rms / 1 min
Rated test voltage main circuit / power supply	2 kV rms / 1 min
Rated test voltage main / main circuit	1.5 kV rms / 1 min
Rated test voltage open contact	1 kV rms / 1 min
Pollution degree	2
Overvoltage category	III

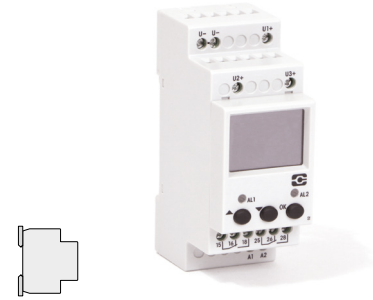
**General data**

Ambient temperature storage	-40 ... 85 °C
Ambient temperature operation	-40 ... 60 °C
Conductor cross section	2.5 mm <sup>2</sup>
Nominal screw torque	0.6 Nm
Module width	fig. 4
Weight	125 g
Protection degree	IP 20
Housing material	PC

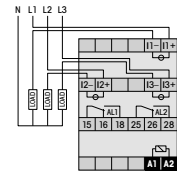
**Product references**

Types	Product reference	12-48	110-240
Three phase monitoring	MRI32/UC...V	✓	✓

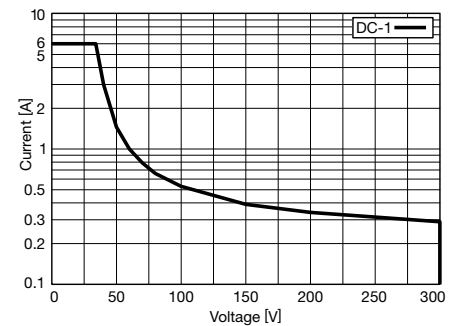
"..." list control circuit voltage to complete product references.  
Other voltages on request. Please contact support@comatreleco.com.



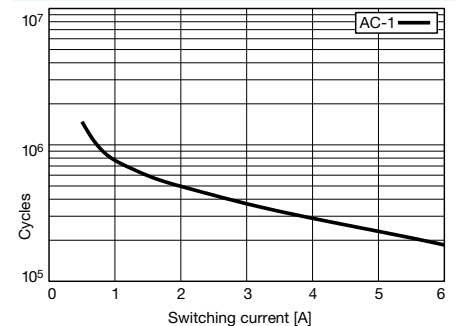
**fig. 1. Wiring diagram**



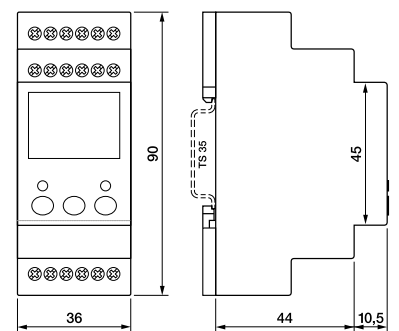
**fig. 2. DC load limit curve**



**fig. 3. AC voltage endurance**



**fig. 4. Dimensions (mm)**



**Standards and approvals**

Standards IEC/EN 60947, IEC/EN 60730, IEC/EN 43880

Approvals



## 3.6 Motor Protection - pluggable

---

Application	Type	Page
<b>TSR Series</b>		
Motor protection   PTC   Clixon   24 ... 48 V UC   230 V AC	TSR19	248

## TSR19

Motor protection | PTC | Clixon | 24 ... 48 V UC | 230 V AC

## Power supply

Nominal voltage	24 ... 48 V UC	230 V AC
Operating voltage range	0.85 ... 1.15 U <sub>N</sub>	
Power consumption AC/DC	5 VA / 5 W	
Rated frequency	50 ... 60 Hz	

## Measuring circuit

Measured parameters	Ω
Monitoring functions	over, sensor ground fault, sensor break
Resistance, OK range	100 ... 1800 Ω
Clixon, OK range	0 ... 1800 Ω
Failure threshold	≤ 50 Ω, ≥ 2250 Ω, ≤ 1 kΩ (to ground)
Alarm delay	2.5 s

## Main circuit

Number of contacts	1 + 1 CO
Contact Material	AgNi
Rated voltage	250 V
Rated current	6 A
Minimum load	10 mA, 12 V
Rated load DC	fig. 2
Rated load AC-1	1250 VA
Mechanical endurance (cycles)	3 x 10 <sup>7</sup>
Electrical endurance at rated load AC-1 (cycles)	fig. 3

## Insulation

Rated test voltage measuring circuit / power supply	2 kV rms / 1 min
Rated test voltage measuring circuit / main circuit	2 kV rms / 1 min
Rated test voltage main circuit / power supply	2 kV rms / 1 min
Rated test voltage main / main circuit	2 kV rms / 1 min
Rated test voltage open contact	1 kV rms / 1 min
Pollution degree	2
Overvoltage category	III

## General data

Ambient temperature storage	-40 ... 85 °C
Ambient temperature operation	-25 ... 60 °C
Module width	fig. 4
Weight	125 g
Protection degree	IP 20
Housing material	PC

## Product references

Types	Product reference	230	24-48
Motor protection, AC supply	TSR19/AC...V	✓	
Motor protection, UC supply	TSR19/UC...V		✓

"..." list control circuit voltage to complete product references.

Other voltages on request. Please contact support@comatreleco.com.

## Accessories

Socket	S3-M
Retaining clip	HF-24
Transparent front cover	FS-23
Front panel mounting set	FZ-23



fig. 1. Wiring diagram

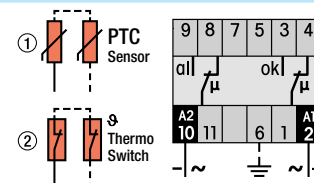


fig. 2. DC load limit curve

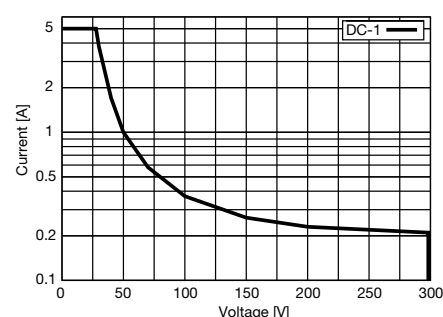


fig. 3. AC voltage endurance

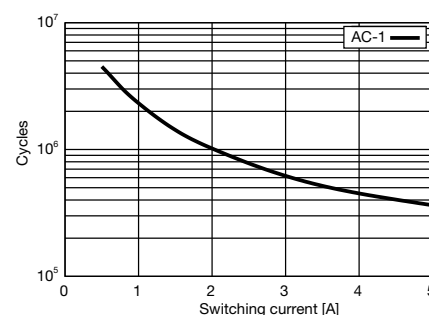
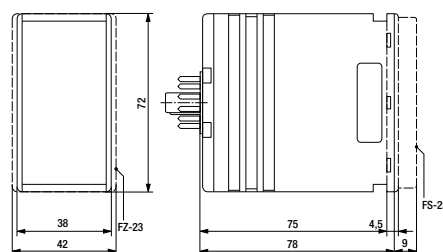


fig. 4. Dimensions (mm)



## Standards and approvals

Standards IEC/EN 60947

Approvals





## 3.7 Isolation Monitoring

---

Application	Type	Page
<b>ESU Series</b>		
DC Isolation monitoring   24 ... 48 V UC	ESU-D2R	250

### 3.7 Isolation Monitoring

## ESU-D2R

### DC Isolation monitoring | 24 ... 48 V UC

#### Power supply

Nominal voltage	24 ... 48 V UC
Operating voltage range	18 ... 60 V
Power consumption AC/DC	2 VA / 2 W
Rated frequency	40 ... 60 Hz

#### Measuring circuit

Measured parameters	$\Omega$
Monitoring functions	under, ground fault
Rated DC voltage U+-U-	60 V
Overvoltage setting range	> 60 VDC
Circuit / ground resistance measurement range	1 ... 50 k $\Omega$
Pre alarm setting range	4 ... 30 k $\Omega$
Main alarm	$\leq 4$ k $\Omega$
Alarm delay	0.1 ... 10 s

#### Main circuit

Number of contacts	1 NO + 2 CO
Contact Material	AgNi
Rated voltage	250 V
Rated current	5 A
Minimum load	10 mA, 12 V
Rated load DC	fig. 2
Rated load AC-1	1250 VA
Mechanical endurance (cycles)	$5 \times 10^6$
Electrical endurance at rated load AC-1 (cycles)	$1 \times 10^5$

#### Insulation

Pollution degree	2
Overvoltage category	III

#### General data

Ambient temperature storage	-40 ... 85 °C
Ambient temperature operation railway version	-40 ... 70 °C
Conductor cross section	2.5 mm <sup>2</sup> , 2 x 1.5 mm <sup>2</sup>
Nominal screw torque	0.5 Nm
Module width	fig. 4
Weight	250 g
Protection degree	IP 20
Housing material	PC

#### Product references

Types	Product reference	24-48
DC Isolation monitoring, railway version	ESU-D2R/UC...V	✓

"..." list control circuit voltage to complete product references.  
Other voltages on request. Please contact support@comatreleco.com.

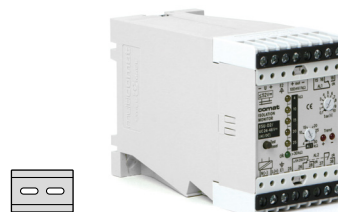


fig. 1. Wiring diagram

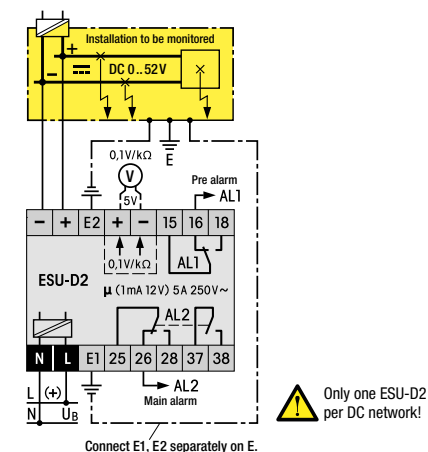


fig. 2. DC load limit curve

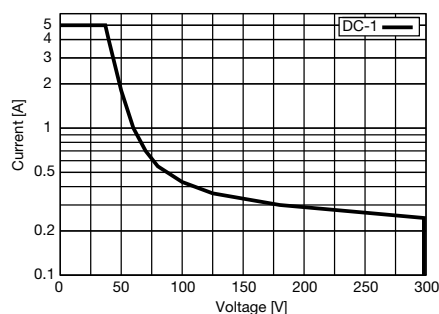
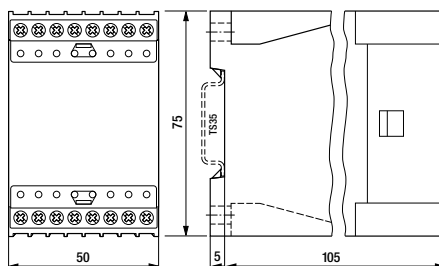


fig. 3. Dimensions (mm)



#### Standards and approvals

Standards IEC/EN 60947, IEC/EN 50155

Approvals

## 3.8 Monitoring Modules

---

Application	Type	Page
<b>CT Series</b>		
Current monitoring   36 V DC	CT515R	252
Voltage monitoring   24 V DC	CT524	253

**CT515R**

**Current monitoring | 36 V DC**

**Power supply**

Nominal voltage	36 V DC
Operating voltage range	18 ... 45 V
Power consumption AC/DC	- / 2.3 V

**Measuring circuit**

Measured parameters	I
Monitoring functions	Under, over, inside, outside
Rated measurement current	2 A
Measurement current range	0 ... 3 A
Undercurrent setting range	0 ... 2 A
Overcurrent setting range	0 ... 2 A
Alarm delay	100 ms / 500 ms / 2 s
Alarm reset delay	100 ms

**General data**

Ambient temperature storage	-40 ... 85 °C
Ambient temperature operation railway version	-40 ... 70 °C
Module width	fig. 2
Weight	25 g
Protection degree	IP 20
Housing material	PC

**Product references**

Types	Product reference	36
Current monitoring, railway version	CT515R/...V	✓

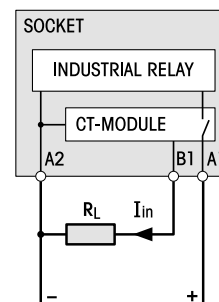
"..." list control circuit voltage to complete product references.  
 Other voltages on request. Please contact [support@comatreleco.com](mailto:support@comatreleco.com).

**Accessories**

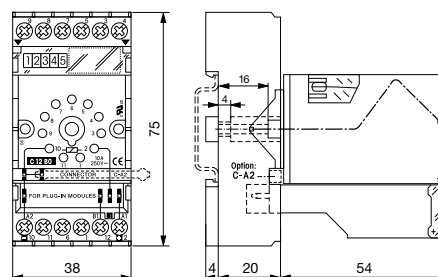
Socket	S3-M0, S5-M
--------	-------------



**fig. 1. Wiring diagram**



**fig. 2. Dimensions (mm)**



**Standards and approvals**

Standards IEC/EN 60947, IEC/EN 50155

Approvals

**CT524**

**Voltage monitoring | 24 V DC**

**Power supply**

Nominal voltage	24 V DC
Operating voltage range	18 ... 30 V
Power consumption AC/DC	- / 0.4 W

**Measuring circuit**

Measured parameters	U
Monitoring functions	Under, over, inside, outside
DC voltage measurement range U+-U-	0 ... 30 V
Undervoltage setting range	0 ... 30 V
Overvoltage setting range	0 ... 30 V
Alarm delay	100 ms / 500 ms / 2 s
Alarm reset delay	100 ms

**General data**

Ambient temperature storage	-40 ... 85 °C
Ambient temperature operation railway version	-40 ... 70 °C
Module width	fig. 2
Weight	25 g
Protection degree	IP 20
Housing material	PC

**Product references**

Types	Product reference	24
Voltage monitoring, railway version	CT524R/...V	✓

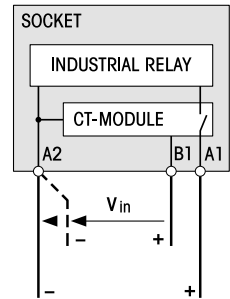
“...” list control circuit voltage to complete product references.  
Other voltages on request. Please contact support@comatreleco.com.

**Accessories**

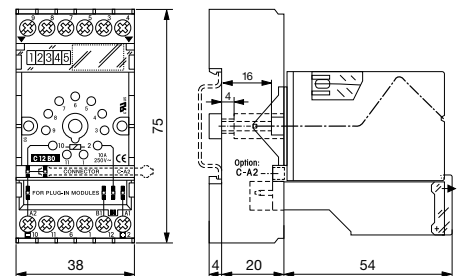
Socket	S3-M0, S5-M
--------	-------------



**fig. 1. Wiring diagram**



**fig. 2. Dimensions (mm)**



**Standards and approvals**

Standards IEC/EN 60947, IEC/EN 50155

Approvals



## 3.9 Suppressor Device

---

Application	Type	Page
<b>CEM Series</b>		
Suppressor device   24 ... 240 V UC	CEM01	256
<b>CRC Series</b>		
Overvoltage protection   24 V UC	CRC02	257

## CEM01

### Suppressor device | 24 ... 240 V UC

#### Power supply

Nominal voltage	24 ... 240 V UC
Operating voltage range	19 ... 250 V
Rated frequency	15 ... 63 Hz

#### General data

Ambient temperature storage	-40 ... 85 °C
Ambient temperature operation	-25 ... 60 °C
Conductor cross section	0.08 ... 2.5 mm <sup>2</sup>
Nominal screw torque	---
Module width	fig. 2
Weight	15 g
Protection degree	IP20
Housing material	PA 66

#### Product references

Types	Product reference	24-240
Suppressor device	CEM01/UC...V	✓

"..." list control circuit voltage to complete product references.  
Other voltages on request. Please contact [support@comatreleco.com](mailto:support@comatreleco.com).

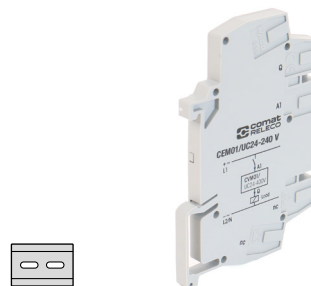


fig. 1. Wiring diagram

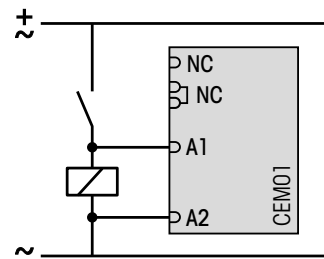
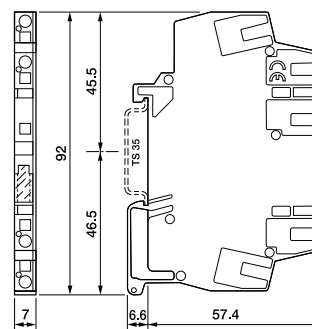


fig. 2. Dimensions (mm)



#### Standards and approvals

Standards

Approvals





## CRC02

### Overvoltage protection | 24 V UC

#### Power supply

Nominal voltage	24 V UC
Operating voltage range	0 ... 30 V DC / 0 ... 38 V AC
Rated frequency	47 ... 63 Hz

#### General data

Ambient temperature storage	-40 ... 85 °C
Ambient temperature operation	-25 ... 60 °C
Conductor cross section	2.5 mm <sup>2</sup> , 2 x 1.5 mm <sup>2</sup>
Nominal screw torque	0.4 N
Module width	fig. 2
Weight	70 g
Protection degree	IP20
Housing material	PC

#### Product references

Types	Product reference	24
Overvoltage protection	CRC02/UC...V	✓

"..." list control circuit voltage to complete product references.  
Other voltages on request. Please contact [support@comatreleco.com](mailto:support@comatreleco.com).



fig. 1. Wiring diagram

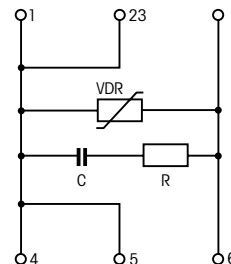
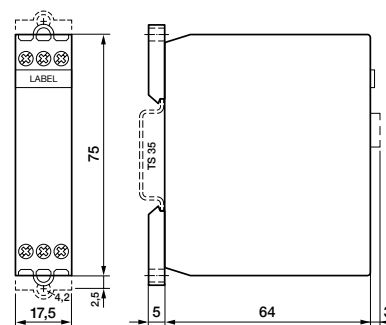


fig. 2. Dimensions (mm)



#### Standards and approvals

Standards

Approvals





## 3.10 Current Transmitter

---

Application	Type	Page
<b>MRE-CT Series</b>		
Current Transmitter   50 / 5 A ... 100 / 5 A	MRE-CT313	260
Current Transmitter   100 / 5 A ... 750 / 5 A	MRE-CT314	261
Current Transmitter   1000 / 5 A ... 1500 / 5 A	MRE-CT614	262
Current Transmitter   2000 / 5 A	MRE-CT1233	263

**MRE-CT313****Current Transmitter | 50 / 5 A ... 100 / 5 A****Power supply**

Operating voltage range &lt; 720 V

**Measuring circuit**

Power consumption at 5 A 0.36 VA/m (2.5 mm<sup>2</sup> wire)  
 Measurement current range  $\leq 1 \times I_N$   
 Max. current  $60 \times I_N$ , 1 s (max. 100 kA)  
 Rated base frequency 50 ... 60 Hz

**Insulation**Rated test voltage measuring / measuring circuit 3 kV rms / 1 min,  $U_m < 720$  V**General data**

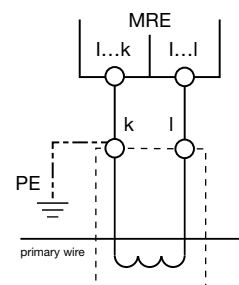
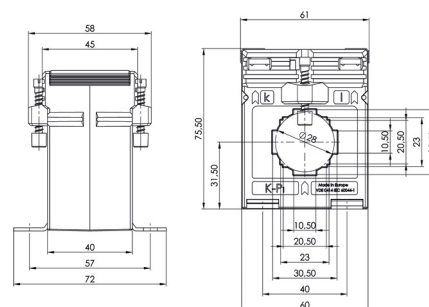
Ambient temperature storage -25 ... 70 °C  
 Ambient temperature operation -5 ... 50 °C  
 Module width fig. 2  
 Weight 120 g  
 Protection degree IP20

**Product references**


Types	Product reference	50	100
Class 1, power 1 VA	MRE-CT313-.../5A/1-1	✓	
Class 1, power 2.5 VA	MRE-CT313-.../5A/2.5-1		✓

"..." list primary current to complete product references.

Other transmission ratio on request. Please contact [support@comatreleco.com](mailto:support@comatreleco.com).

**fig. 1. Wiring diagram****fig. 2. Dimensions (mm)****Standards and approvals**

Standards IEC/EN 61869

Approvals 

## MRE-CT314

### Current Transmitter | 100 / 5 A ... 750 / 5 A

#### Power supply

Operating voltage range < 720 V

#### Measuring circuit

Power consumption at 5 A 0.36 VA/m (2.5 mm<sup>2</sup> wire)  
 Measurement current range  $\leq 1 \times I_N$   
 Max. current  $60 \times I_N, 1 \text{ s (max. 100 kA)}$   
 Rated base frequency 50 ... 60 Hz

#### Insulation

Rated test voltage measuring / measuring circuit 3 kV rms / 1 min,  $U_m < 720 \text{ V}$

#### General data

Ambient temperature storage -25 ... 70 °C  
 Ambient temperature operation -5 ... 50 °C  
 Module width fig. 2  
 Weight 180 g  
 Protection degree IP20

#### Product references

Types	Product reference	100	150	200	250	300	400	500	600	750
Class 0.2s, power 2.5 VA	MRE-CT314-.../5A/2.5-0.2S	✓	✓	✓						
Class 0.2s, power 5 VA	MRE-CT314-.../5A/5-0.2S					✓	✓	✓	✓	✓
Class 0.5, power 2.5 VA	MRE-CT314-.../5A/2.5-0.5	✓	✓	✓	✓					
Class 0.5, power 5 VA	MRE-CT314-.../5A/5-0.5					✓	✓	✓	✓	✓

"..." list primary current to complete product references.

Other transmission ratio on request. Please contact support@comatreleco.com.



fig. 1. Wiring diagram

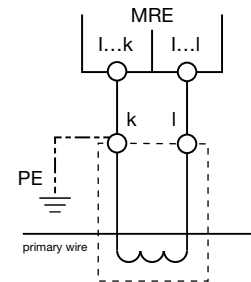
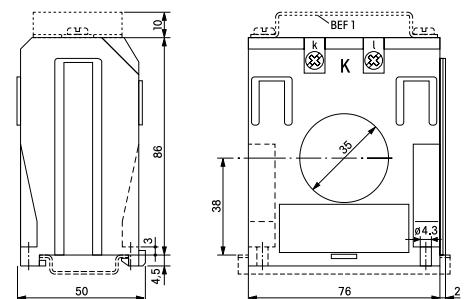


fig. 2. Dimensions (mm)



#### Standards and approvals

Standards IEC/EN 61869

Approvals

**MRE-CT614****Current Transmitter | 1000 / 5 A ... 1500 / 5 A****Power supply**

Operating voltage range &lt; 720 V

**Measuring circuit**

Power consumption at 5 A 0.36 VA/m (2.5 mm<sup>2</sup> wire)  
 Measurement current range  $\leq 1 \times I_N$   
 Max. current  $60 \times I_N$ , 1 s (max. 100 kA)  
 Rated base frequency 50 ... 60 Hz

**Insulation**Rated test voltage measuring / measuring circuit 3 kV rms / 1 min,  $U_m < 720$  V**General data**

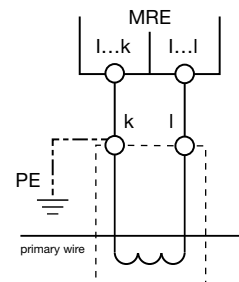
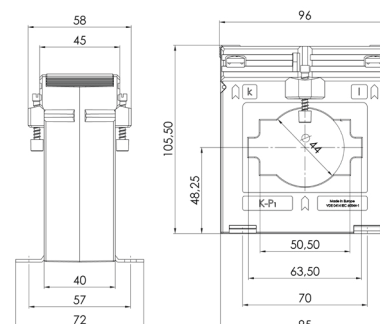
Ambient temperature storage -25 ... 70 °C  
 Ambient temperature operation -5 ... 50 °C  
 Module width fig. 2  
 Weight 260 g  
 Protection degree IP20

**Product references**

Types	Product reference	1000	1250	1500
Class 0.2s, power 10 VA	MRE-CT614-.../5A/10-0.2S	✓	✓	✓
Class 0.5, power 10 VA	MRE-CT614-.../5A/10-0.2S	✓	✓	✓

"..." list primary current to complete product references.

Other transmission ratio on request. Please contact [support@comatreleco.com](mailto:support@comatreleco.com).

**fig. 1. Wiring diagram****fig. 2. Dimensions (mm)****Standards and approvals**

Standards IEC/EN 61869

Approvals 

## MRE-CT1233

### Current Transmitter | 2000 / 5 A

#### Power supply

Operating voltage range < 720 V

#### Measuring circuit

Power consumption at 5 A 0.36 VA/m (2.5 mm<sup>2</sup> wire)  
 Measurement current range  $\leq 1 \times I_N$   
 Max. current  $60 \times I_N, 1 \text{ s (max. 100 kA)}$   
 Rated base frequency 50 ... 60 Hz

#### Insulation

Rated test voltage measuring / measuring circuit 3 kV rms / 1 min,  $U_m < 720 \text{ V}$

#### General data

Ambient temperature storage -25 ... 70 °C  
 Ambient temperature operation -5 ... 50 °C  
 Module width fig. 2  
 Weight 340 g  
 Protection degree IP20

#### Product references

Types	Product reference	2000
Class 0.2s, power 10 VA	MRE-CT1233-.../5A/10-0.2S	✓
Class 0.5, power 10 VA	MRE-CT1233-.../5A/10-0.2S	✓

"..." list primary current to complete product references.

Other transmission ratio on request. Please contact support@comatreleco.com.



fig. 1. Wiring diagram

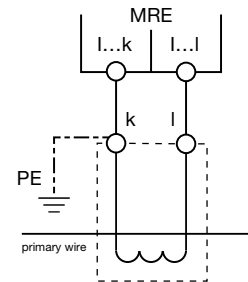
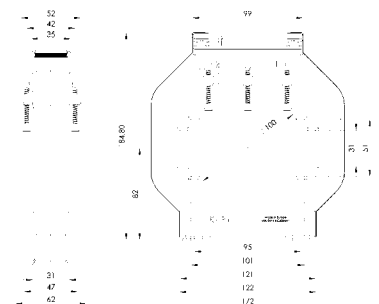


fig. 2. Dimensions (mm)



#### Standards and approvals

Standards IEC/EN 61869

Approvals





## 3.11 Monitoring Relay Accessories

---

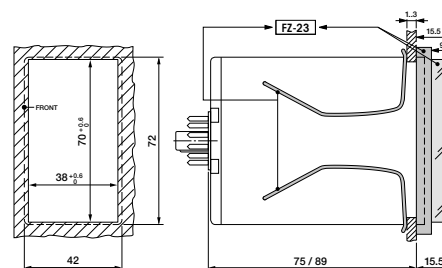
Application	Type	Page
<b>Accessories</b>		
Front panel mounting set   Retaining clip	FZ-23	266
Transparent front cover	FS-23	267
Retaining clip   Plastic	HF-24	268

**FZ-23****Front panel mounting set | Retaining clip****General data**

Ambient temperature storage	-40 ... 85 °C
Ambient temperature operation	-25 ... 60 °C
Module width	fig. 1
Weight	19 g

**Product references**

Types	Product reference
Front panel mounting set	FZ-23

**fig. 1. Dimensions (mm)**

## FS-23

### Transparent front cover

#### General data

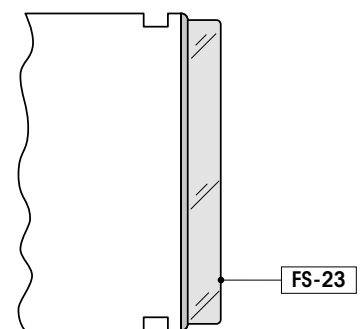
Ambient temperature storage	-40 ... 85 °C
Ambient temperature operation	-25 ... 60 °C
Module width	fig. 1
Weight	80 g



#### Product references

Types	Product reference
Transparent front cover	FS-23

fig. 1. Dimensions (mm)

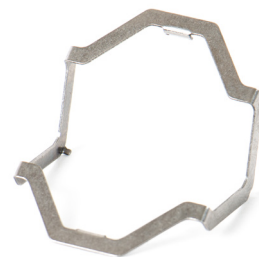


## HF-24

### Retaining clip | Plastic

#### General data

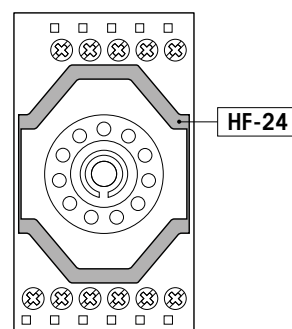
Ambient temperature storage	-40 ... 85 °C
Ambient temperature operation	-25 ... 60 °C
Module width	fig. 1
Weight	20 g
Housing material	PC



#### Product references

Types	Product reference
Retaining clip	HF-24

fig. 1. Dimensions (mm)



## 4 Sockets

---

Socket Selection for industrial Relays																									
Socket Type	Description	C2	C3	C4	C5	C7	C9	C10	C12	C16PTL / C18PTL	C18-A15PT	C21	C22	C31	C32	R7	R-Module	CS2 / CS3 / C64	C55 / C56	C83 / C85	CT2	CT3	CT32 / CT33 / CT36	CT515 / CT524	KDM
EC-11	Socket for industrial Relay		●											●	●										
S2-B	Socket for industrial Relay	●																				●			
S2-S *	Socket for industrial Relay	●										●	●									●			
S2-L *	Socket for industrial Relay	●																				●			
S2-P *	Socket for industrial Relay	●																				●			
S2-P0 *	Socket for industrial Relay	●																				●			
S3-B	Socket for industrial Relay		●											●	●			●	●				●		
S3-MP	Socket for industrial Relay		●											●	●			●	●				●		
S3-S	Socket for industrial Relay		●											●	●			●	●				●		
S3-P *	Socket for industrial Relay																	●	●				●		
S3-P0 *	Socket for industrial Relay																	●	●				●		
S3-M0	Socket for industrial Relay		●											●	●		●						●	●	
S3-M1	Socket for industrial Relay		●											●	●			●	●				●		
S3-M	Socket for industrial Relay		●											●	●			●	●				●		
S4-J	Socket for industrial Relay			●																					
S4-L	Socket for industrial Relay			●																					
S4-P	Socket for industrial Relay			●																					
S5-M	Socket for industrial Relay				●													●					●	●	
S5-L	Socket for industrial Relay				●																				
S5-P	Socket for industrial Relay																								
S7-C	Socket for industrial Relay					●											●	●			●				●
S7-I0	Socket for industrial Relay					●											●	●							
S7-16	Socket for industrial Relay					●											●	●							
S7-P *	Socket for industrial Relay					●											●								
S7-L *	Socket for industrial Relay					●											●								
S9-M	Socket for industrial Relay						●																		
S9-P	Socket for industrial Relay						●																		
S9-L *	Socket for industrial Relay						●																		
S9-P0	Socket for industrial Relay																								
S10	Socket for industrial Relay							●																	
S10-P	Socket for industrial Relay							●																	
S12	Socket for industrial Relay								●																
S12-P	Socket for industrial Relay								●																
S16-M	Socket for industrial Relay									●								●							
S18-M	Socket for industrial Relay										●							●							

\* Discontinued, limited units may be still available from stock.



Socket Accessoires																	
Type	Description	S3-M	S3-M0	S3-M1	S2-B	S3-B	S5-M	S7-C	S10	S7-I0	S12	S9-M	S4-J	S7-L	S7-P	S9-L	S9-P
CA-11	Code Ring (BAG 5 PCS)					●											
C-A2	Neutral-Connector (BAG 5 PCS or 50 PCS)	●	●	●			●										
SC-3	A1-Connector (BAG 10 PCS)		●	●			●										
LH-1	Label carrier transparent (BAG 5 PCS)	●	●	●													
SL-36	Label holder transparent (BAG 5 PCS)				●	●											
SP-36	Labeling strips (BAG 5 PCS)				●	●											
L-16	Labeling strips (BAG 5 PCS)	●	●	●													
SD-1T	Lock lid transparent (BAG 5 PCS)	●	●	●			●										
SD-1W	Lock lid white (BAG 5 PCS)	●	●	●			●										
B20-G	Bridge Bar grey (BAG 5 PCS)										●						
B20-R	Bridge Bar red (BAG 5 PCS)										●						
B20-A	Bridge Bar blue (BAG 5 PCS)										●						
PS-W	Labeling strips							●									
S7-BB	Bridge bar (BAG 5 PCS ( 5 x 4 ))							●		●							
S9-CH	Labeling srib white (BAG 10 PCS)									●		●					
S10-BB	Bridge bar (BAG 20 PCS ( 5 x 4 ))								●								
S10-RH	Labeling srib white (BAG 10 PCS)								●		●						
S10-RT	Transparent Cover (BAG 20 PCS)								●								
SA-0	Wall Adapter							●	●		●						
SS-T	Transparent Cover							●									
SS-W	White Cover							●									
V10-G	Bridge Bar grey (BAG 5 PCS)										●						
V10-R	Bridge Bar red (BAG 5 PCS)										●						
V10-A	Bridge Bar blue (BAG 5 PCS)										●						
V40-G	Bridge Bar grey (BAG 5 PCS)										●						
V40-R	Bridge Bar red (BAG 5 PCS)										●						
V40-A	Bridge Bar blue (BAG 5 PCS)										●						

Socket type	Made in	C2 ESP	C2 ESP + CT2	C2 IND	C2 IND + CT2	C3 ESP	C3 ESP + CT3	C3 IND	C3 ESP + CT3	C4 ESP	C4 CN	C5 ESP	C5 CN	C7 ESP	C7 CN	C9 ESP	C9 CN	C10 ESP	C10 CN	C10 IND	C12 ESP	C12 IND	C16PTL / C18PTL	C18-15PT	C21	C21 + CT2	C22	C22 + CT2	C31	C31 + CT3	C32	C32 + CT3	R3 ESP	R3 IND	R7 ESP	R7 CN		
EC-8	ESP	S3-C	HF-32		HF-32		S3-C		HF-32																													
EC-11	ON																																					
S2-B, S2-S	ON	S3-OM CP-15B S3-C	S3-OM HF-32	S3-CT	S3-OM HF-32	HF-33																																
S20-B	ESP	S3-OM CP-15B S3-C	S3-OM HF-32	S3-CT	S3-OM HF-32	HF-33																																
S2-L, S2-P, S2-PO	ESP	S3-C	HF-32		HF-32																																	
S3-B	ON						S3-OM CP-15B S3-C	S3-CT	S3-OM HF-32	HF-33																												
S30-B	ESP						S3-OM CP-15B S3-C	S3-CT	S3-OM HF-32	HF-33																												
S3-MP	ESP						S3-OM CP-15B S3-C	S3-CT	S3-OM HF-32	HF-33																												
S3-S	ON						S3-OM CP-15B S3-C	S3-CT	S3-OM HF-32	HF-33																												
S3-L, S3-P, S3-PO	ESP						S3-C		HF-32																													
S3-M0	ESP						S3-C	S3-CT	HF-32	HF-33																												
S4-J	ON						S3-OM CP-15B S3-C				S3-OM CP-15B S3-C																											
S4-L, S4-P, S4-PO	ESP						S4-CL				S4-CL																											
S5-S	ESP																																					
S5-M	ON																																					
S7-C	ON																																					
S7-H0	ESP																																					
S7-H0	ON																																					
S7-16	ESP																																					
S7-P																																						
S7-L, S7-PO	ESP																																					
S9-M	ON																																					
S9-P																																						
S9-L, S9-PO	ESP																																					
S10	ON																																					
S10-P	ON																																					
S12	ON																																					
S12-P	ESP																																					
S16-M	ON																																					
S18-M	ON																																					



## 4.1 8-Pin Sockets

---

Application	Type	Pins	Page
<b>8-Pin Series</b>			
Socket for 8-pin Relays and Time Cubes	S2-B		274
Socket for 8-pin Relays and Time Cubes	S2-PO		275

**S2-B**

**Socket for 8-pin Relays and Time Cubes**



**Rated Load** **10 A / 300 V**

**Specifications**

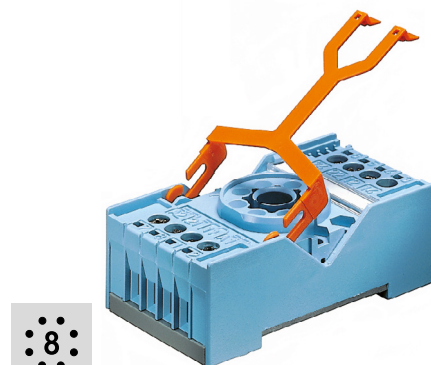
Rated impulse withstand voltage	2.5 kV rms / 1 min
- All terminals / DIN rail	2.5 kV rms / 1 min
- Terminal / Terminal	
Cross-section of connecting wire	
- Single-wire	4 mm <sup>2</sup> / AWG 12 or 2 x 2.5 mm <sup>2</sup> / AWG 14
- Multi-wire	0.34 mm <sup>2</sup> / AWG 22 - 2.5 mm <sup>2</sup> / AWG 14
Nominal screw torque	0.7 Nm
Screw Dimensions (mm)	M3 Pozi slot
Mounting	TS-35 or Back Panel Mounting
Ambient temperature operation / storage	-40...60 °C / -40 ... 80 °C (no ice)
Weight	48g

**Included Accessories**

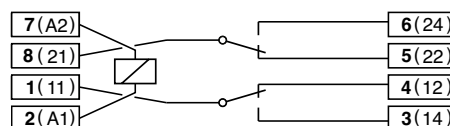
Retaining Clip, plastic S30-CM for C2 / C2x Relays

**Optional Accessories**

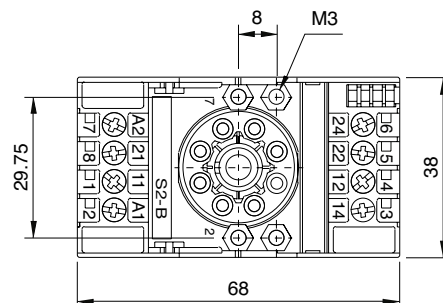
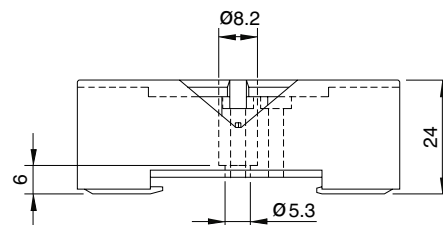
Retaining clip, steel HF-32 (BAG 10 PCS) for C2 / C2x Relays  
HF-33 (BAG 10 PCS) for Time Cube CTx



**Connection diagram**



**Dimensions (mm)**



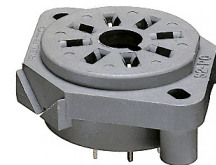
**Technical approvals, conformities**



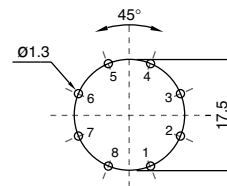
## S2-PO

### Socket for 8-pin Relays and Time Cubes

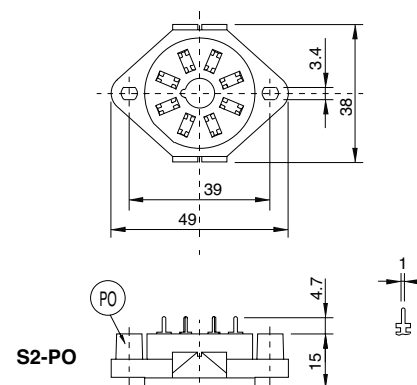
<b>Rated Load</b>	<b>10 A / 300 V</b>
<b>Specifications</b>	
Rated impulse withstand voltage	2.5 kV rms / 1 min
- Pin / Pin	
Ambient temperature operation/storage	-40 ... 60 °C / -40 ... 80 °C (no ice)
Weight	17g
<b>Optional Accessories</b>	
Retaining clip, steel	HF-32 (BAG 10 PCS) for C2 / C2x Relays HF-33 (BAG 10 PCS) for Time Cube CTx



#### Printed circuit lay-out (mm)



#### Dimensions (mm)











#### Technical approvals, conformities





## 4.2 11-Pin Sockets

Application	Type	Pins	Page
<b>11-Pin Series</b>			
Socket for 11-pin Relays and Time Cubes	S3-B		278
Socket for 11-pin standard Relays and Time Cubes	S3-S		279
Socket for 11-pin standard Relays	EC-11		280
Socket for 11-pin Relays and Time / Monitoring Module	S3-M		281
Socket for 11-pin Relays and Time / Monitoring Module	S3-M0 / S3-M1		282
Socket for 11-pin Relays	S5-M		283
PCB Socket for 11-pin Relays	S5-P		284
Socket for 11-pin Relays	S5-SSY		285

**S3-B**

**Socket for 11-pin Relays and Time Cubes**

**Rated Load** **10 A / 300 V**

**Specifications**

Rated impulse withstand voltage	
- All terminals / DIN rail	2.5 kV rms / 1 min
- Terminal / Terminal	2.5 kV rms / 1 min
Cross-section of connecting wire	
- Single-wire	4 mm <sup>2</sup> / AWG 12 or 2 x 2.5 mm <sup>2</sup> / AWG 14
- Multi-wire	0.34 mm <sup>2</sup> / AWG 22 - 2.5 mm <sup>2</sup> / AWG 14
Nominal screw torque	0.7 Nm
Screw Dimensions (mm)	M3 Pozi slot
Mounting	TS-35 or Back Panel Mounting
Ambient temperature	-40 ... 60 °C / -40 ... 80 °C (no ice)
Weight	55g

**Included Accessories**

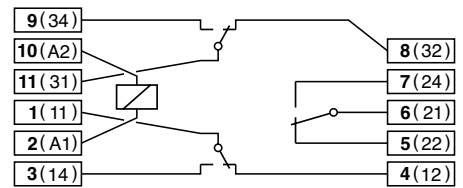
Retaining Clip, plastic S30-CM for C3 / C3x Relays

**Optional Accessories**

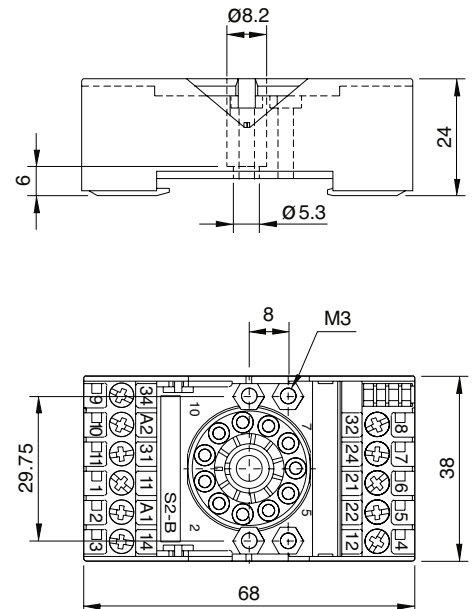
Retaining clip, steel HF-32 (BAG 10 PCS) for C3 / C3x Relays  
 Coding Ring HF-33 (BAG 10 PCS) for Time Cube CTx  
S3-BC (BAG 5 PCS) for C3 / C3x Relays



**Connection diagram**



**Dimensions (mm)**



**Technical approvals, conformities**



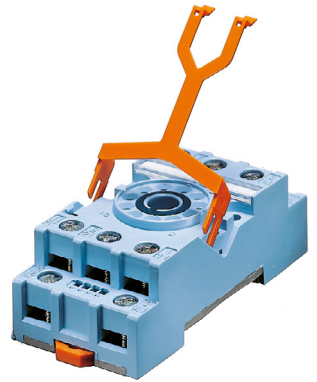
**S3-S**

**Socket for 11-pin standard Relays and Time Cubes**

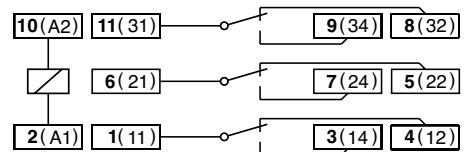
<b>Rated Load</b>	<b>10 A / 250 V</b>
<b>Specifications</b>	
Rated impulse withstand voltage	2.5 kV rms / 1 min
- All terminals / DIN rail	2.5 kV rms / 1 min
- Terminal / Terminal	2.5 kV rms / 1 min
Cross-section of connecting wire	
- Single-wire	4 mm <sup>2</sup> / AWG 12 or 2 x 2.5 mm <sup>2</sup> / AWG 14
- Multi-wire	0.34 mm <sup>2</sup> / AWG 22 - 2.5 mm <sup>2</sup> / AWG 14
Nominal screw torque	1.2 Nm
Screw Dimensions (mm)	M3.5 Pozi slot
Mounting	TS-35 or Back Panel Mounting
Ambient temperature operation/storage	-40...60 °C / -40 ... 80 °C (no ice)
Weight	69g

<b>Included Accessories</b>	
Retaining Clip, plastic	S30-CM for C3 / C3x Relays

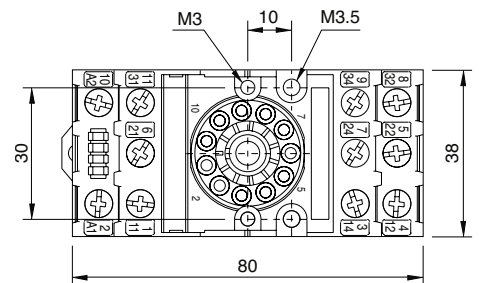
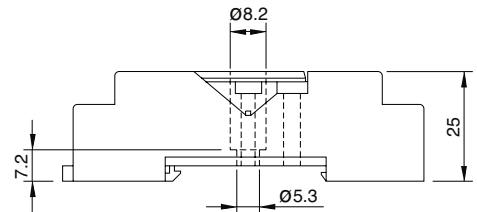
<b>Optional Accessories</b>	
Retaining clip, steel	HF-32 (BAG 10 PCS) for C3 / C3x Relays HF-33 (BAG 10 PCS) for Time Cube CTx
Coding Ring	S3-BC (BAG 5 PCS) for C3 / C3x Relays



**Connection diagram**



**Dimensions (mm)**



4.2 11-Pin Sockets

**Technical approvals, conformities**



## EC-11

### Socket for 11-pin standard Relays

**Rated Load**

**10 A / 400 V**

**Specifications**

Rated impulse withstand voltage

– All terminals / DIN rail

2.5 kV rms / 1 min

– Terminal / Terminal

2.5 kV rms / 1 min

Cross-section of connecting wire

– Single-wire

4 mm<sup>2</sup> / AWG 12 or 2 x 2.5 mm<sup>2</sup> / AWG 14

– Multi-wire

0.34 mm<sup>2</sup> / AWG 22 - 2.5 mm<sup>2</sup> / AWG 14

Nominal screw torque

0.7 Nm

Screw Dimensions (mm)

M3.5 Pozi slot

Mounting

TS-35 or Back Panel Mounting

Ambient temperature operation/storage

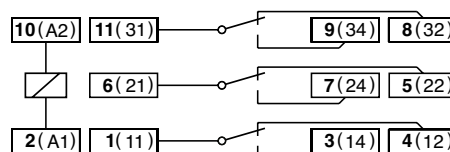
-25...60 °C / -40 ... 80 °C (no ice)

Weight

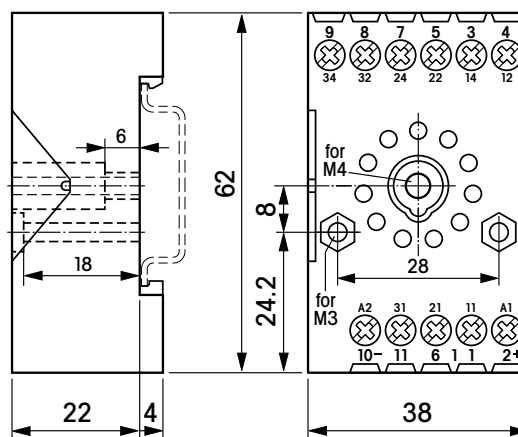
56 g



**Connection diagram**



**Dimensions (mm)**



**Technical approvals, conformities**





**S3-M**

**Socket for 11-pin Relays and Time / Monitoring Module**



**Rated Load** **10 A / 250 V**

**Specifications**

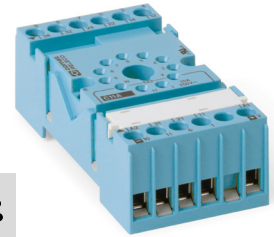
Rated impulse withstand voltage	2.5 kV rms / 1 min
- All terminals / DIN rail	2.5 kV rms / 1 min
- Terminal / Terminal	2.5 kV rms / 1 min
Cross-section of connecting wire	
- Single-wire	1 x 6 mm <sup>2</sup> / AWG 10, 2 x 1.5 mm <sup>2</sup> / AWG 16
- Multi-wire	1 x 4 mm <sup>2</sup> /AWG 12, 2 x 1.5 mm <sup>2</sup> /AWG 16
Nominal screw torque	0.7 Nm
Screw Dimensions (mm)	M3 Pozi slot
Mounting	TS-35 or Back Panel Mounting
Ambient temperature operation/storage	-25 ... 60 °C / -40 ... 80 °C (no ice)
Weight	61g

**Included Accessories**

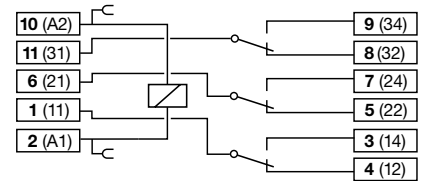
A2-Connector C-A2

**Optional Accessories**

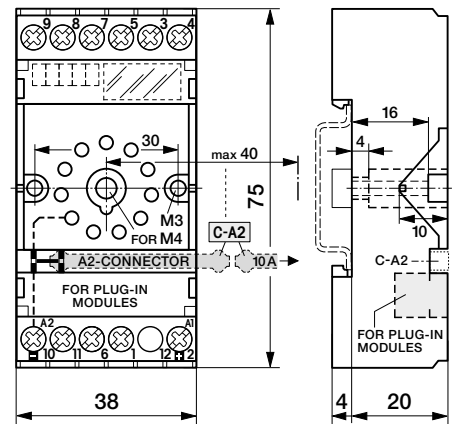
Retaining clip, steel HF-32 (BAG 10 PCS) for C3 / C3x Relays  
HF-33 (BAG 10 PCS) for Time Cube CTx  
 Coding Ring S3-BC (BAG 5 PCS) for C3 / C3x Relays  
 A2-Connector C-A2 (BAG 5 PCS), C-A2 (BAG 50 PCS)  
 Free-wheeling Diode Module RD1/DC12-220V  
 RC-Suppressor Module RC1/UC110-240V



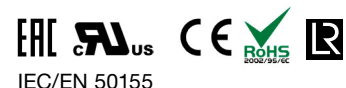
**Connection diagram**



**Dimensions (mm)**



**Technical approvals, conformities**



**S3-M0 / S3-M1**

**Socket for 11-pin Relays and Time / Monitoring Module**



**Rated Load** **10 A / 250 V**

**Specifications**

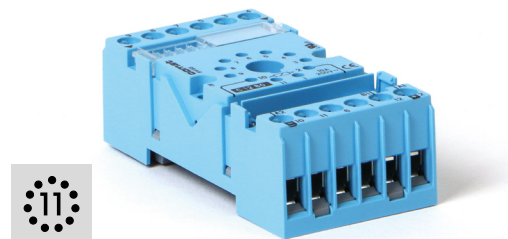
Rated impulse withstand voltage	2.5 kV rms / 1 min
- All terminals / DIN rail	2.5 kV rms / 1 min
- Terminal / Terminal	
Cross-section of connecting wire	
- Single-wire	1 x 6 mm <sup>2</sup> / AWG 10, 2 x 1.5 mm <sup>2</sup> / AWG 16
- Multi-wire	1 x 4 mm <sup>2</sup> /AWG 12, 2 x 1.5 mm <sup>2</sup> /AWG 16
Nominal screw torque	0.7 Nm
Screw Dimensions (mm)	M3 Pozi slot
Mounting	TS-35 or Back Panel Mounting
Ambient temperature operation/storage	-25 ... 60 °C / -40 ... 80 °C (no ice)
Weight	61g

**Included Accessories**

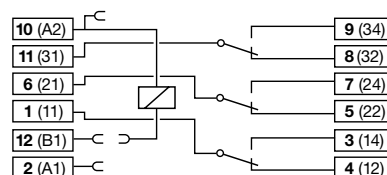
A2-Connector C-A2

**Optional Accessories**

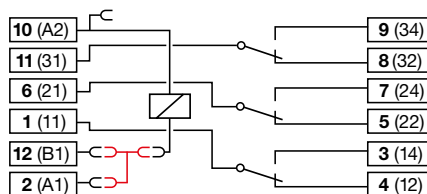
Retaining clip, steel	HF-32 (BAG 10 PCS) for C3 / C3x Relays HF-33 (BAG 10 PCS) for Time Cube CTx
Coding Ring	S3-BC (BAG 5 PCS) for C3 / C3x Relays
A2-Connector	C-A2 (BAG 5 PCS), C-A2 (BAG 50 PCS)
Free-wheeling Diode Module	RD1/DC12-220V
RC-Suppressor Module	RC1/UC110-240V



**Connection diagram S3-M0**

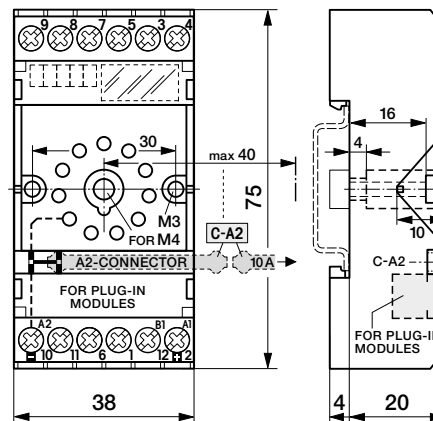


**Connection diagram S3-M1**



With Bridge Connector SC-3

**Dimensions (mm)**



**Technical approvals, conformities**



IEC/EN 50155

## S5-M

### Socket for 11-pin Relays

**Rated Load** **16 A / 400 V**

#### Specifications

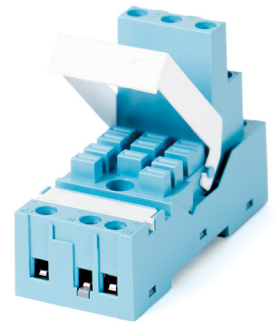
Rated impulse withstand voltage	4 kV rms / 1 min
– All terminals / DIN rail	4 kV rms / 1 min
– Terminal / Terminal	4 kV rms / 1 min
Cross-section of connecting wire	
– Single-wire	1 x 6 mm <sup>2</sup> / AWG 10, 2 x 2.5 mm <sup>2</sup> / AWG 14
– Multi wire	1 x 6 mm <sup>2</sup> / AWG 10, 2 x 1.5 mm <sup>2</sup> / AWG 16
Nominal screw torque	1 Nm
Screw Dimensions (mm)	M3.5 Pozi slot
Mounting	TS-35 or Back Panel Mounting
Ambient temperature operation / storage	-40 ... 60° C / -40 ... 80° C (no ice)
Weight	92g

#### Integrated Accessories

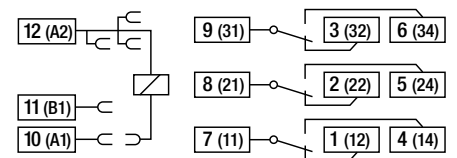
A2-Connector	C-A2
Retaining clip, plastic	S5M-CP for C5 / C5x Relays
A1-, B1-Connector	SC-3

#### Optional Accessories

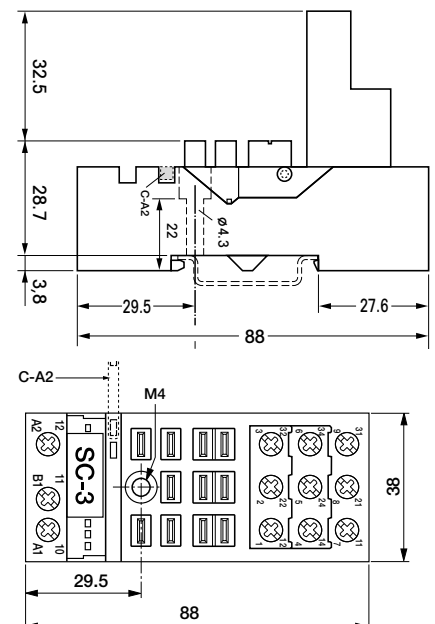
Retaining Clip, steel	HF-32 (BAG 10 PCS) for C5 / C5x Relays
A2-Connector	C-A2 (BAG 5 PCS), C-A2 (BAG 50 PCS)
A1-, B1-Connector	SC-3 (BAG 10 PCS)



#### Connection diagram



#### Dimensions (mm)



#### Technical approvals, conformities



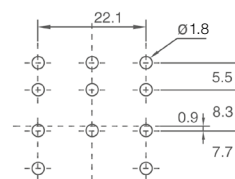
## S5-P

### PCB Socket for 11-pin Relays

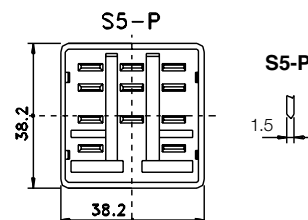
<b>Rated Load</b>	<b>16 A / 400 V</b>
<b>Specifications</b>	
Rated impulse withstand voltage	2.5 kV rms / 1 min
- Pin / Pin	-40 ... 60 °C / -40 ... 80 °C (no ice)
Ambient temperature operation/storage	-40 ... 60 °C / -40 ... 80 °C (no ice)
Weight	20g
<b>Optional Accessories</b>	
Retaining spring, steel	S5-CL (BAG 10 PCS) for C5 / C5x Relays



#### Printed circuit lay-out (mm)



#### Dimensions (mm)



#### Technical approvals, conformities



**S5-SSY**

**Socket for 11-pin Relays**

**Rated Load** **16 A / 400 V**

**Specifications**

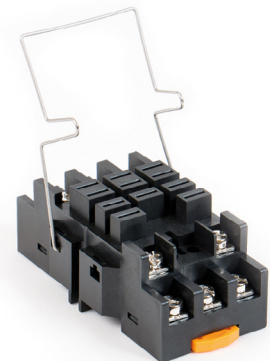
Rated impulse withstand voltage	4 kV rms / 1 min
- All terminals / DIN rail	4 kV rms / 1 min
- Terminal / Terminal	4 kV rms / 1 min
Cross-section of connecting wire	
- Single-wire	1 x 6 mm <sup>2</sup> / AWG 10, 2 x 2.5 mm <sup>2</sup> / AWG 14
- Multi wire	1 x 6 mm <sup>2</sup> / AWG 10, 2 x 1.5 mm <sup>2</sup> / AWG 16
Nominal screw torque	1 Nm
Screw Dimensions (mm)	M3.5 Pozi slot
Mounting	TS-35 or Back Panel Mounting
Ambient temperature operation / storage	-40 ... 60° C / -40 ... 80° C (no ice)
Weight	92g

**Integrated Accessories**

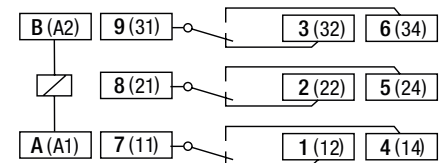
A2-Connector	C-A2
Retaining clip, plastic	S5M-CP for C5 / C5x Relays
A1-, B1-Connector	SC-3

**Optional Accessories**

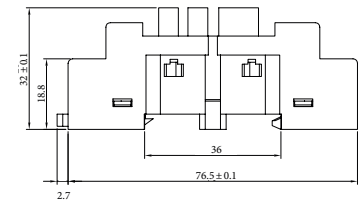
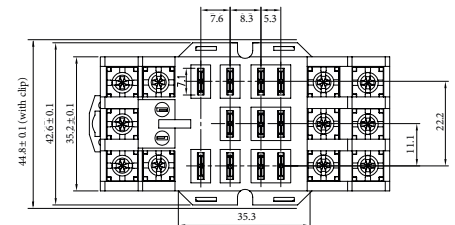
Retaining Clip, steel	HF-32 (BAG 10 PCS) for C5 / C5x Relays
A2-Connector	C-A2 (BAG 5 PCS), C-A2 (BAG 50 PCS)
A1-, B1-Connector	SC-3 (BAG 10 PCS)



**Connection diagram**



**Dimensions (mm)**





**Technical approvals, conformities**





## 4.3 14-Pin Sockets

---

Application	Type	Pins	Page
<b>14-Pin Series</b>			
Socket for 14-pin C4 Relays	S4-J		288
PCB Socket for 14-pin C4 Relays	S4-P		289

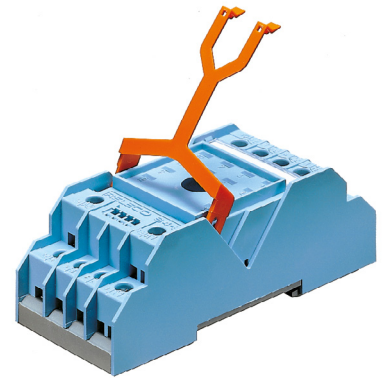
## S4-J

### Socket for 14-pin C4 Relays

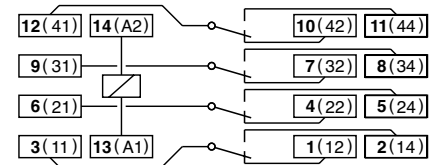
<b>Rated Load</b>	<b>10 A / 250 V</b>
<b>Specifications</b>	
Rated impulse withstand voltage	2.5 kV rms / 1 min
- All terminals / DIN rail	2.5 kV rms / 1 min
- Terminal / Terminal	
Cross-section of connecting wire	
- Single-wire	1.5 mm <sup>2</sup> / AWG 15 or 2 x 1.5 mm <sup>2</sup> / AWG 15
- Multi-wire	0,34 mm <sup>2</sup> / AWG 22 - 1 mm <sup>2</sup> / AWG 17
Nominal screw torque	1 Nm
Screw Dimensions (mm)	M3.5 Philips-slot (combo)
Mounting	TS-35 or Back Panel Mounting
Ambient temperature	-40 ... 60 °C / -40 ... 80 °C (no ice)
Weight	80g

<b>Included Accessories</b>	
Retaining Clip, plastic	S3-C for C4 / C4x Relays

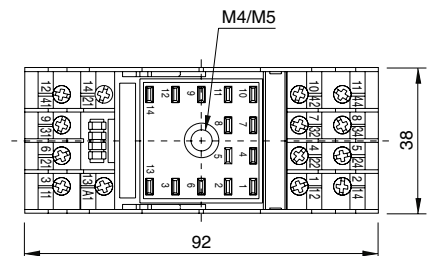
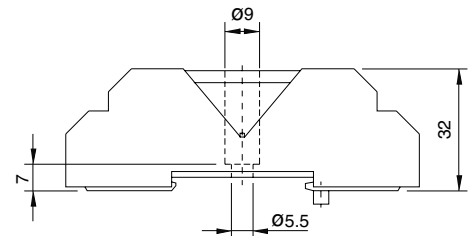
<b>Optional Accessories</b>	
Retaining Clip, plastic	S3-C (BAG 10 PCS) for C4 Relays



#### Connection diagram



#### Dimensions (mm)



#### Technical approvals, conformities





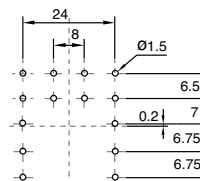
## S4-P

### PCB Socket for 14-pin C4 Relays

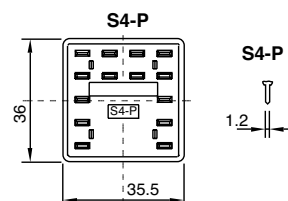
<b>Rated Load</b>	<b>10 A / 250 V</b>
<b>Specifications</b>	
Rated impulse withstand voltage	2.5 kV rms / 1 min
- Pin / Pin	-30 °C ... +60 °C (no ice)
Ambient temperature	-30 °C ... +60 °C (no ice)
Weight	21g
<b>Optional Accessories</b>	
Retaining spring, steel	S4-CL (BAG 10 PCS) for C4 / C4x Relays



#### Printed circuit lay-out (mm)



#### Dimensions (mm)








#### Technical approvals, conformities





## 4.4 8/14-Pin Sockets

---

Application	Type	Pins	Page
<b>8/14-Pin Series</b>			
Socket for 8-pin Relays	S7-C		292
Socket for 8-pin Relays	S7-IO		293
PCB Socket for 8-pin Relays	S7-P		294
Socket for 14-pin Relays	S9-M		295
PCB Socket for 14-pin Relays	S9-P		296

## S7-C

### Socket for 8-pin Relays

**Rated Load** **10A, 16A for 1 pole / 250 V**

#### Specifications

Rated impulse withstand voltage	
- All terminals / DIN rail	2.5 kV rms / 1 min
- Terminal / Terminal	2.5 kV rms / 1 min
Cross-section of connecting wire	
- Single-wire	4 mm <sup>2</sup> / AWG 12, 2 x 1.5 mm <sup>2</sup> / AWG 16
- Multi wire	2.5 mm <sup>2</sup> / AWG 14, 2 x 1 mm <sup>2</sup> / AWG 18
Nominal screw torque	0.7 Nm
Screw Dimensions (mm)	M3 Pozi slot
Mounting	TS-35 or Back Panel Mounting
Ambient temperature operation/storage	-40...60°C (50°C for 16A)/-40...80°C (no ice)
Weight	37g

#### Included Accessories

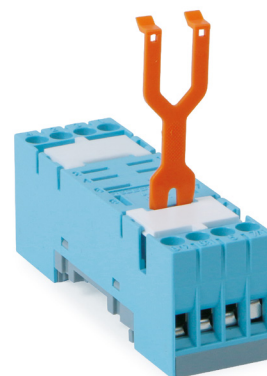
Retaining clip, plastic CP-07B for C7 / C7x Relays

#### Optional Accessories

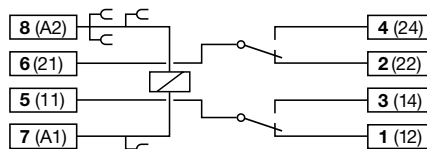
Retaining clip, plastic CP-07B (BAG 50 PCS) for C7 / C7x Relays  
 A2-Connector S7-BB (BAG 20 PCS)  
 Panel Adapter S9-G (BAG 10 PCS)

#### Please Note:

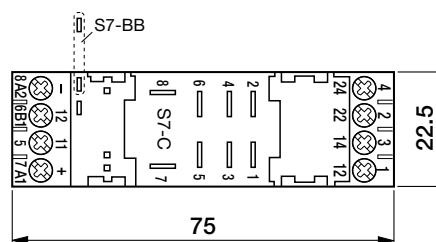
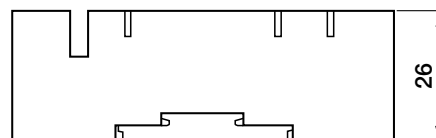
This socket replaces former socket S7-M and S7-16



#### Connection diagram



#### Dimensions (mm)



#### Technical approvals, conformities



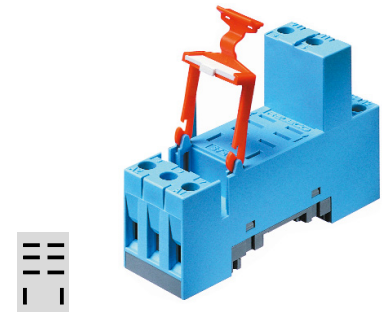
## S7-IO

### Socket for 8-pin Relays

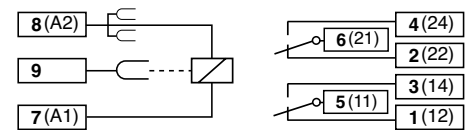
<b>Rated Load</b>	<b>10 A / 250 V</b>
<b>Specifications</b>	
Rated impulse withstand voltage	2.5 kV rms / 1 min
- All terminals / DIN rail	2.5 kV rms / 1 min
- Terminal / Terminal	2.5 kV rms / 1 min
Cross-section of connecting wire	
- Single-wire	4 mm <sup>2</sup> / AWG 12, 2 x 2.5 mm <sup>2</sup> / AWG 14
- Multi wire	0.34 mm <sup>2</sup> / AWG 22 - 2.5 mm <sup>2</sup> / AWG 14
Nominal screw torque	0.7 Nm
Screw Dimensions (mm)	M3 Pozi slot
Mounting	TS-35 or Back Panel Mounting
Ambient temperature operation/storage	-40...60 °C / -40 ... 80 °C (no ice)
Weight	38g

<b>Included Accessories</b>	
Retaining clip, plastic	S9-C for C7 / C7x Relays

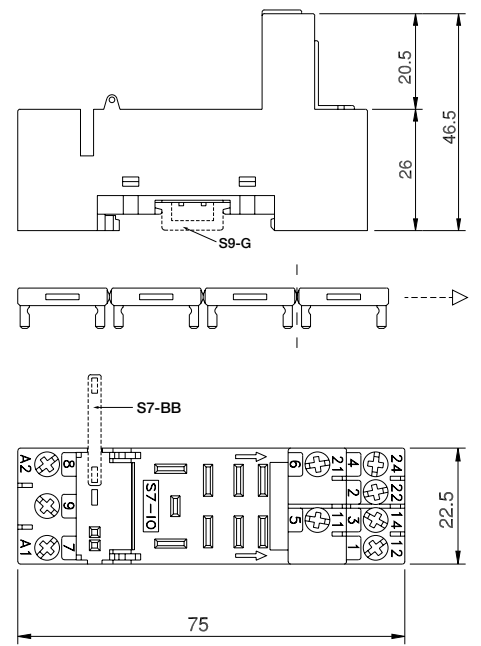
<b>Optional Accessories</b>	
Retaining clip, plastic	S9-C (BAG 10 PCS) for C7 / C7x Relays
A2-Connector	S7-BB (BAG 20 PCS)
Panel Adapter	S9-G (BAG 10 PCS)



#### Connection diagram



#### Dimensions (mm)



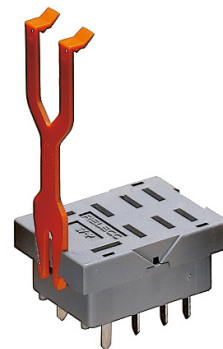
#### Technical approvals, conformities



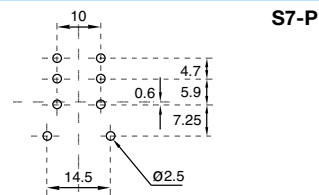
# S7-P

## PCB Socket for 8-pin Relays

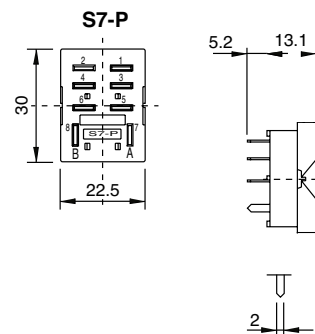
<b>Rated Load</b>	<b>10 A / 250 V</b>
<b>Specifications</b>	
Rated impulse withstand voltage	2.5 kV rms / 1 min
- Pin / Pin	-40 ... 60 °C / -40 ... 80 °C (no ice)
Ambient temperature operation/storage	-40 ... 60 °C / -40 ... 80 °C (no ice)
Weight	10g
<b>Included Accessories</b>	
Retaining clip, plastic	CP-07B for C7 / C7x Relays
<b>Optional Accessories</b>	
Retaining clip, plastic	CP-07B (BAG 50 PCS) for C7 / C7x Relays



### Printed circuit lay-out (mm)



### Dimensions (mm)



### Technical approvals, conformities



## S9-M

### Socket for 14-pin Relays

**Rated Load** **6 A / 250 V**

#### Specifications

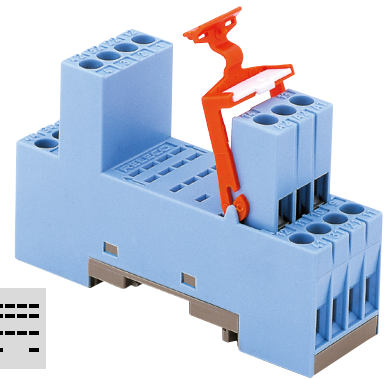
Rated impulse withstand voltage	2.5 kV rms / 1 min
- All terminals / DIN rail	2.5 kV rms / 1 min
- Terminal / Terminal	
Cross-section of connecting wire	
- Single-wire	4 mm <sup>2</sup> / AWG 12 or 2 x 2.5 mm <sup>2</sup> / AWG 14
- Multi-wire	0.34mm <sup>2</sup> / 22 - 2.5 mm <sup>2</sup> / AWG 14
Nominal screw torque	0.7 Nm
Screw Dimensions (mm)	M3 Pozi slot
Mounting	TS-35 or Back Panel Mounting
Ambient temperature operation/storage	-40 ... 60 °C / -40 ... 80 °C (no ice)
Weight	54g

#### Included Accessories

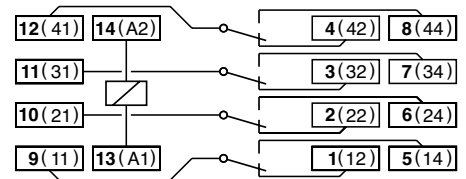
Retaining clip, plastic S9-C for C9 / C9x Relays

#### Optional Accessories

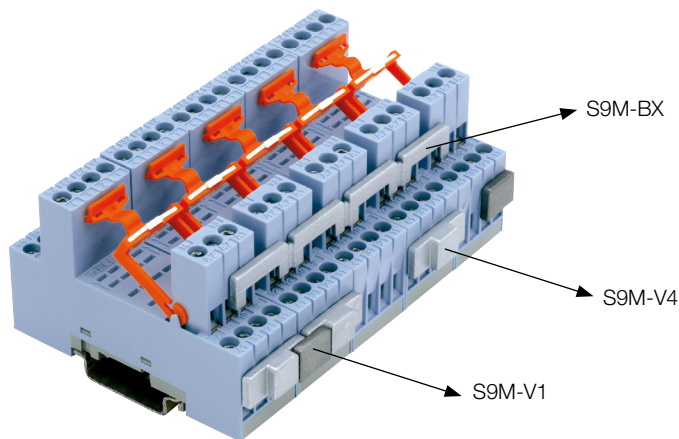
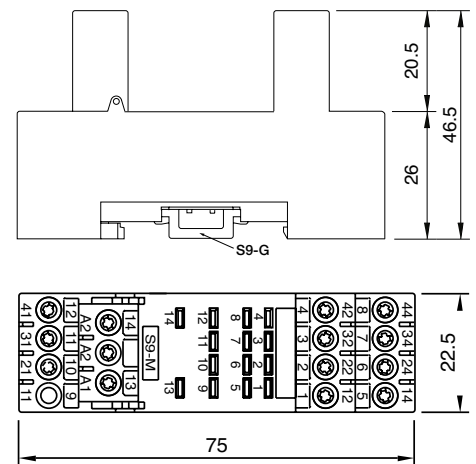
Retaining clip, plastic S9-C (BAG 10 PCS) for C9 / C9x Relays  
 Panel Adapter S9-G (BAG 10 PCS)  
 Bridge Bar S9M-V1 (BAG 5 PCS)  
 Bridge Bar S9M-V4 (BAG 5 PCS)  
 Bridge Bar S9M-BX (BAG 5 PCS)



#### Connection diagram



#### Dimensions (mm)



#### Technical approvals, conformities



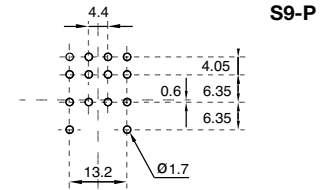
## S9-P

### PCB Socket for 14-pin Relays

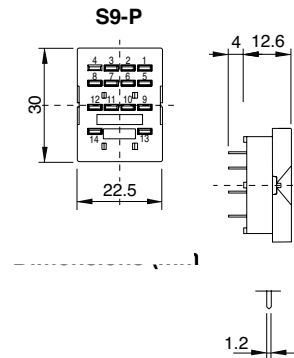
<b>Rated Load</b>	<b>6 A / 150 V</b>
<b>Specifications</b>	
Rated impulse withstand voltage	1.5 kV rms / 1 min
- Pin / Pin	
Ambient temperature operation/storage	-40 ... 60 °C / -40 ... 80 °C (no ice)
Weight	12 g
<b>Included Accessories</b>	
Retaining clip, plastic	CP-07B for C9 / C9x Relays
<b>Optional Accessories</b>	
Retaining clip, plastic	CP-07B (BAG 50 PCS) for C9 / C9x Relays



#### Printed circuit lay-out (mm)



#### Dimensions (mm)



This print socket must be used in pollution degree 2 environment only, hence office, laboratory, household or similar. It is not suitable for industry environment (pollution degree 3).



Maximum voltage between two separate circuits on neighbouring contacts: 150 V  
**Not permitted:** 24 V DC next to 230 V AC, 230 V AC next to neutral, 230 V AC next to 230 V AC of different phases  
**Permitted:** 230 V AC next to 230 V AC same phase







#### Technical approvals, conformities





## 4.5 5/8-Pin Sockets

---

Application	Type	Pins	Page
<b>5/8-Pin Series</b>			
Socket for 5-pin Relays	S10		298
PCB Socket for 5-pin Relays	S10-P		299
Socket for 8-pin Relays	S12		300
PCB Socket for 8-pin Relays	S12-P		301
Socket for 8-pin Relays	S16-M		302
Socket for 8-pin Relays	S18-M		303

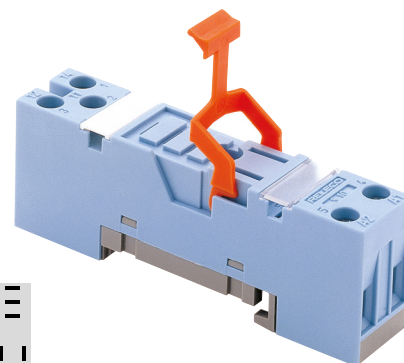
# S10

## Socket for 5-pin Relays

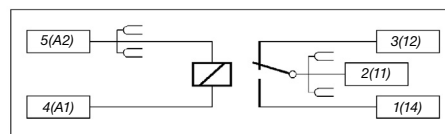
<b>Rated Load</b>	<b>10 A / 250 V</b>
<b>Specifications</b>	
Rated impulse withstand voltage	5 kV rms / 1 min
- All terminals / DIN rail	2.5 kV rms / 1 min
- Contact / Terminals	5 kV rms / 1 min
- Contact / Coil terminals	5 kV rms / 1 min
Cross-section of connecting wire	
- Single-wire	4 mm <sup>2</sup> / AWG 12 or 2 x 2.5 mm <sup>2</sup> / AWG 14
- Multi-wire	0.34mm <sup>2</sup> / 22 - 2.5 mm <sup>2</sup> / AWG 14
Nominal screw torque	0.7 Nm
Screw Dimensions (mm)	M3 Pozi slot
Mounting	TS-35 or Back Panel Mounting
Ambient temperature operation/storage	-40...60 °C / -40 ... 80 °C (no ice)
Weight	23g

<b>Included Accessories</b>	
Retaining Clip, plastic	S10-C for C10 / C10x Relays

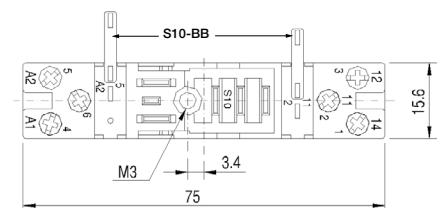
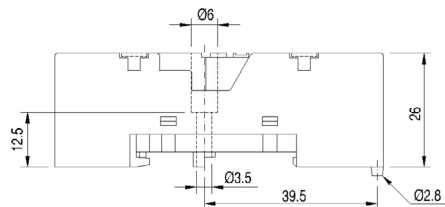
<b>Optional Accessories</b>	
Retaining clip, plastic	S10-C / CP-17B (BAG 10 PCS) for C10 / C10x
Bridge bar	S10-BB (BAG 20 PCS)



### Connection diagram



### Dimensions (mm)



### Technical approvals, conformities



# S10-P

## PCB Socket for 5-pin Relays

**Rated Load** **10 A / 250 V**

**Specifications**

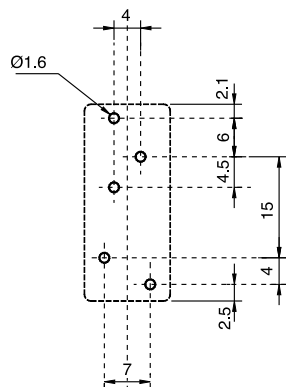
Rated impulse withstand voltage	
- Pin / Pin	5 kV rms / 1 min
Ambient temperature operation/storage	-40 ... 60 °C / -40 ... 80 °C (no ice)
Weight	7g

**Included Accessories**

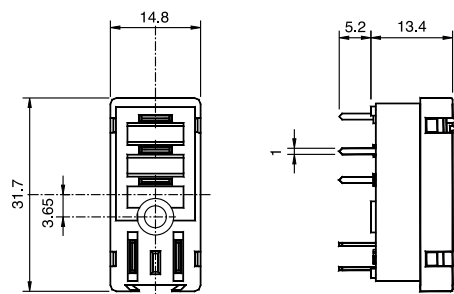
Retaining clip, plastic



**Printed circuit lay-out (mm)**



**Dimensions (mm)**



4.5 5/8-Pin Sockets



**Technical approvals, conformities**



# S12

## Socket for 8-pin Relays

**Rated Load**

**5 A / 250 V**

**Specifications**

Rated impulse withstand voltage	5 kV rms / 1 min
- All terminals / DIN rail	2.5 kV rms / 1 min
- Contact / Terminals	5 kV rms / 1 min
- Contacts / Coil terminals	5 kV rms / 1 min
Cross-section of connecting wire	
- Single-wire	4 mm <sup>2</sup> / AWG 12 or 2 x 2.5 mm <sup>2</sup> / AWG 14
- Multi-wire	0.34mm <sup>2</sup> / 22 - 2.5 mm <sup>2</sup> / AWG 14
Nominal screw torque	0.7 Nm
Screw Dimensions (mm)	M3 Pozi slot
Mounting	TS-35 or Back Panel Mounting
Ambient temperature operation/storage	-40 ... 60 °C / -40 ... 80 °C (no ice)
Weight	31g

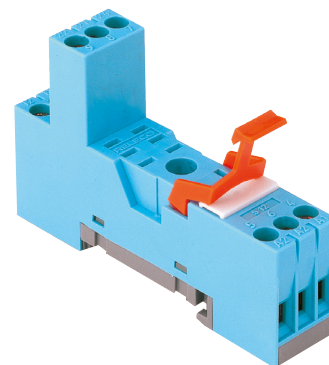
**Included Accessories**

Retaining Clip, plastic S10-C for C12 / C12x Relays

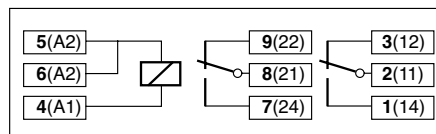
**Optional Accessories**

Retaining Clip, plastic S10-C / CP-17B (BAG 10 PCS) for C12 / C12x Relays

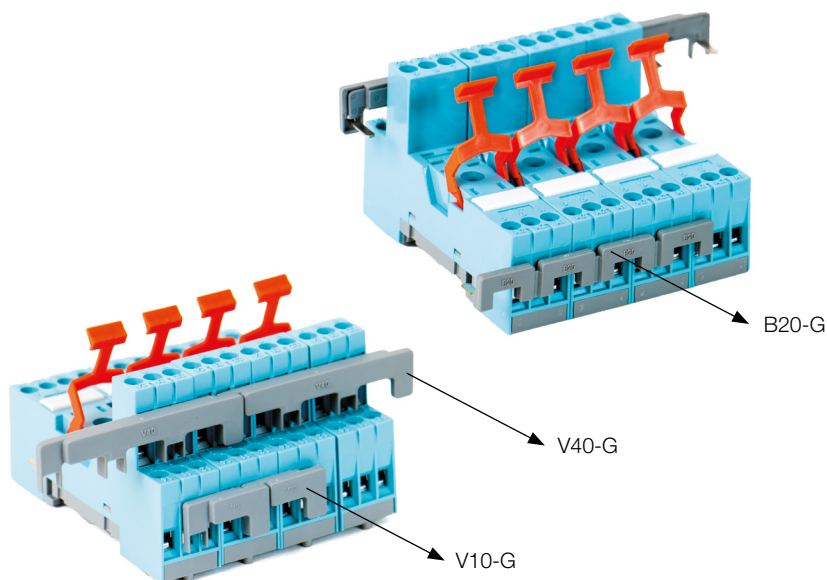
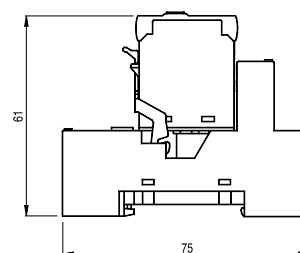
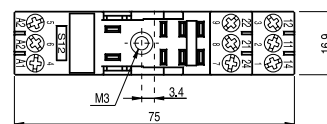
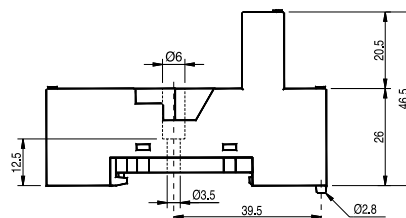
A2-Connector grey B20-G (BAG 5 PCS)  
 A2-Connector red B20-R (BAG 5 PCS)  
 A2-Connector blue B20-A (BAG 5 PCS)  
 Bridge Bar twofold grey V10-G (BAG 5 PCS)  
 Bridge Bar twofold red V10-RC (BAG 5 PCS)  
 Bridge Bar twofold blue V10-AC (BAG 5 PCS)  
 Bridge Bar fourfold grey V40-G (BAG 5 PCS)  
 Bridge Bar fourfold red V40-R (BAG 5 PCS)  
 Bridge Bar fourfold blue V40-AC (BAG 5 PCS)



**Connection diagram**



**Dimensions (mm)**



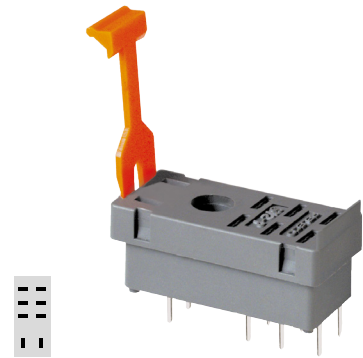
**Technical approvals, conformities**



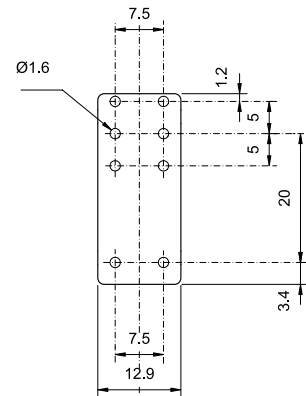
## S12-P

### PCB Socket for 8-pin Relays

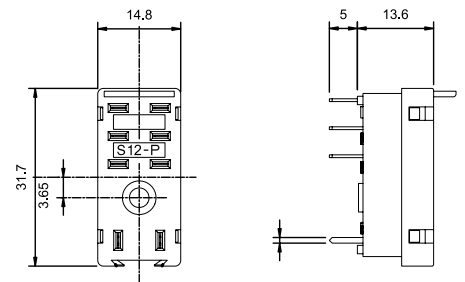
<b>Rated Load</b>	<b>5 A / 250 V</b>
<b>Specifications</b>	
Rated impulse withstand voltage	
- Pin / Pole	3 kV rms / 1 min
- Coil / contact terminals	5 kV rms / 1 min
Weight	7g
<b>Included Accessories</b>	
Retaining clip, plastic	CP-24B (BAG 10 PCS) for C12 / C12x Relays



Printed circuit lay-out (mm)



Dimensions (mm)



Technical approvals, conformities



**S16-M****Socket for 8-pin Relays****Rated Load****10 A / 300 V****Specifications**

Rated impulse withstand voltage

– All terminals / DIN rail

3 kV rms / 1 min

– Terminal / Terminal

3 kV rms / 1 min

– Terminal / Coil

3 kV rms / 1 min

Cross-section of connecting wire

– Single-wire

1 × 0.5 mm<sup>2</sup> / AWG 20

– Multi-wire

1 × 2.5 mm<sup>2</sup> / AWG 14 or 2 × 1.0 mm<sup>2</sup> / AWG 18

Nominal screw torque

0.7 Nm

Screw Dimensions (mm)

M3 Pozzi 1 slot 2

Mounting

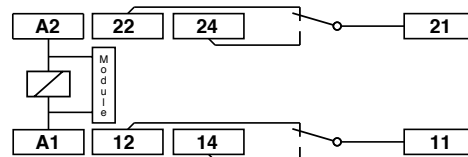
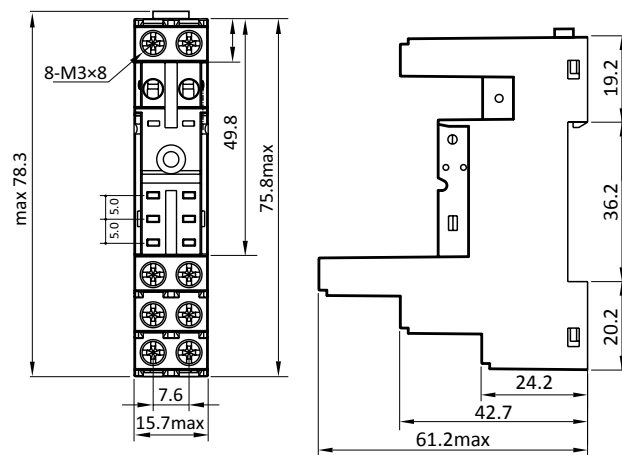
TS-35 or Back Panel Mounting

Ambient temperature

-40...60 °C / -40 ... 80 °C (no ice)

Weight

42 g

**Connection diagram****Dimensions (mm)****Included Accessories**

Retaining / Ejector clip, plastic

CP-16

**Optional Accessories (modules)**

Free wheeling diode

RD16/DC12-240V

Green LED &amp; free wheeling diode, 6-24V DC

RDL16/DC6-24V

Green LED &amp; free wheeling diode, 24-60V DC

RDL16/DC24-60V

Green LED &amp; free wheeling diode, 110-240V DC

RDL16/DC110-240V

Green LED, 6-24V AC/DC

RL16/UC6-24V

Green LED, 24-60V AC/DC

RL16/UC24-60V

Green LED, 110-240V AC/DC

RL16/UC110-240V

RC-Network 6-24V

RC16/UC6-24V

RC-Network 24-60V

RC16/UC24-60V

RC-Network 110-240V

RC16/UC110-240V

**Technical approvals, conformities**

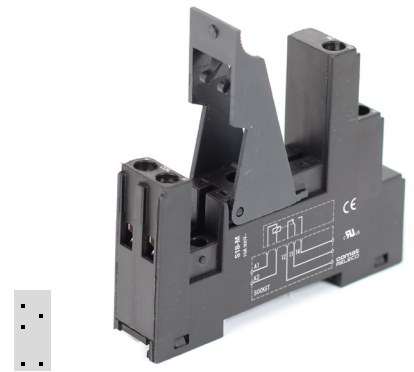
## S18-M

### Socket for 8-pin Relays

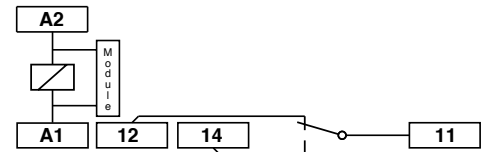
<b>Rated Load</b>	<b>10 A / 300 V</b>
<b>Specifications</b>	
Rated impulse withstand voltage	3 kV rms / 1 min
- All terminals / DIN rail	3 kV rms / 1 min
- Terminal / Terminal	3 kV rms / 1 min
- Terminal / Coil	3 kV rms / 1 min
Cross-section of connecting wire	
- Single-wire	1 × 0.5 mm <sup>2</sup> / AWG 20
- Multi-wire	1 × 2.5 mm <sup>2</sup> / AWG 14 or 2 × 1.0 mm <sup>2</sup> / AWG 18
Nominal screw torque	0.7 Nm
Screw Dimensions (mm)	M3 Pozzi 1 slot 2
Mounting	TS-35 or Back Panel Mounting
Ambient temperature	-40 ... 60 °C / -40 ... 80 °C (no ice)
Weight	42 g

<b>Included Accessories</b>	
Retaining / Ejector clip, plastic	CP-16

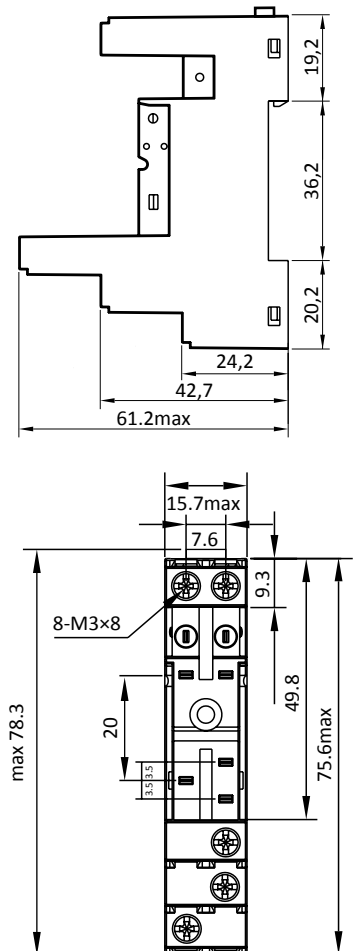
<b>Optional Accessories (modules)</b>	
Free wheeling diode	RD16/DC12-240V
Green LED & free wheeling diode, 6-24V DC	RDL16/DC6-24V
Green LED & free wheeling diode, 24-60V DC	RDL16/DC24-60V
Green LED & free wheeling diode, 110-240V DC	RDL16/DC110-240V
Green LED, 6-24V AC/DC	RL16/UC6-24V
Green LED, 24-60V AC/DC	RL16/UC24-60V
Green LED, 110-240V AC/DC	RL16/UC110-240V
RC-Network 6-24V	RC16/UC6-24V
RC-Network 24-60V	RC16/UC24-60V
RC-Network 110-240V	RC16/UC110-240V



#### Connection diagram



#### Dimensions (mm)



#### Technical approvals, conformities







## 5 Remote Monitoring & Control

---



## 5.1 ComatReleco Messaging System (SMS Relay)

---

Application	Type	Page
<b>CMS-Series</b>		
6 digital inputs   4 relay outputs   12 ... 48 V DC   110 ... 240 V AC	CMS-10F	308
6 analogue / digital inputs   4 relay outputs   12 ... 48 V DC	CMS-10ADF	309
4 analogue / digital inputs   2 inputs 4 ... 20 mA   4 relay outputs   12 ... 48 V DC	CMS-10ACDF	310

**CMS-10F****6 digital inputs | 4 relay outputs | 12 ... 48 V DC | 110 ... 240 V AC****Power supply**

Nominal voltage	12 ... 48 V DC	110 ... 240 V AC
Operating voltage range	10 ... 60 V DC	85 ... 250 V AC
Power consumption AC/DC	8 VA / 4.2 W	
Rated frequency	45 ... 63 Hz	

**Inputs**

Number of digital inputs	6	
Nominal voltage digital inputs	12 ... 48 V DC	110 ... 240 V AC
High level threshold digital Inputs	9.5 V DC	85 V AC

**Outputs**

Number of relay outputs	4
Contact Material	⚡ AgNi
Rated voltage	250 V AC
Rated current	10 A
Minimum contact load relay outputs	10 mA, 12V
Inrush current	15 A, 20 ms
Rated load AC-1	2500 VA
Mechanical endurance	3 x 10 <sup>7</sup>
Electrical endurance at rated load AC-1	150 000

**Communication**

Communication standards	GSM (2G), as of Q2 2019 UMTS (3G), LTE (4G)
Frequencies	850 / 900 / 1800 / 1900 MHz
Antenna connector	SMA female

**Insulation**

Rated test voltage control / main circuit	2.5 kV, 1 min
Rated test voltage main / main circuit	2.5 kV, 1 min
Pollution degree	3
Overvoltage category	II

**General data**

Ambient temperature storage	-40 ... 85 °C
Ambient temperature operation	-25 ... 55 °C
Conductor cross section	2.5 mm <sup>2</sup>
Nominal screw torque	0.5 Nm
Weight	120 g
Protection degree	IP20
Housing material	PC

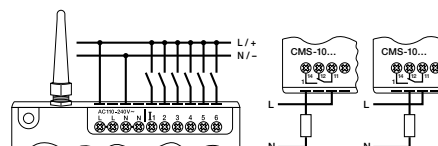
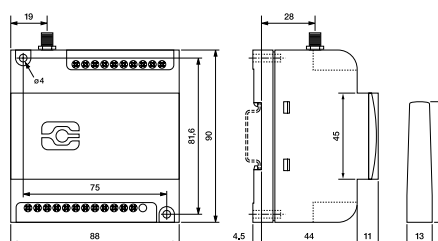
**Product references**

Types	Product reference	12-48	110-240
DC supply	CMS-10F/DC...V	✓	
DC supply, kit (*included accessories)	CMS-10FKIT/DC...V	✓	
AC supply	CMS-10F/AC...V		✓
AC supply, kit (*included accessories)	CMS-10FKIT/AC...V		✓

"..." list control circuit voltage to complete product references.

**Accessories**

Antennas	CMS-ANT-SPEZ/5M, CMS-ANT-MAG/2.5M*
Antenna cables	CMS-ANT-KAB/5M, CMS-ANT-KAB/10M, CMS-ANT-KAB/20M
Programming cable	CMS-RS232*
USB to serial converter	CMS-USB*
Power supply 15W, 24V	DR-15-24
Power supply 30W, 24V	DR-30-24
PT100 / PT1000 amplifier	MV-LKM-274
Indoor temperature sensor with display, 0 ... 50 °C	CRF01-U-D
Indoor temperature sensor, 0 ... 50 °C	CRF01-U
Exterior temperature sensor, -50 ... +50 °C	CWF50-EXT-U4
Thermostat, 5 ... 30 °C	CRTBSB-001-010
Temperature / humidity sensor	KS-110
Water level sensor	PS1

**fig. 1. Wiring diagram****fig. 2. Dimensions (mm)****Standards and approvals**

Standards IEC/EN 60947, IEC/EN60730

Approvals



**CMS-10ADF****6 analogue / digital inputs | 4 relay outputs | 12 ... 48 V DC****Power supply**

Nominal voltage	12 ... 48 V DC
Operating voltage range	10 ... 60 V DC
Power consumption AC/DC	4.2 W

**Inputs**

Number of analogue / digital inputs	6
Nominal voltage digital inputs	12 ... 48 V DC
High level threshold digital Inputs	9.5 V DC
Nominal range analogue inputs	0 ... 10 V
Resolution of analogue inputs	10 Bit

**Outputs**

Number of relay outputs	4
Contact Material	⚡ AgNi
Rated voltage	250 V AC
Rated current	10 A
Minimum contact load relay outputs	10 mA, 12V
Inrush current	15 A, 20 ms
Rated load AC-1	2500 VA
Mechanical endurance	3 x 10 <sup>7</sup>
Electrical endurance at rated load AC-1	150 000

**Communication**

Communication standards	GSM (2G), as of Q2 2019 UMTS (3G), LTE (4G)
Frequencies	850 / 900 / 1800 / 1900 MHz
Antenna connector	SMA female

**Insulation**

Rated test voltage control / main circuit	2.5 kV, 1 min
Rated test voltage main / main circuit	2.5 kV, 1 min
Pollution degree	3
Overvoltage category	II

**General data**

Ambient temperature storage	-40 ... 85 °C
Ambient temperature operation	-25 ... 55 °C
Conductor cross section	2.5 mm <sup>2</sup>
Nominal screw torque	0.5 Nm
Weight	120 g
Protection degree	IP20
Housing material	PC

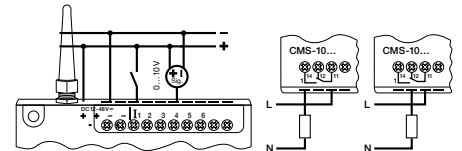
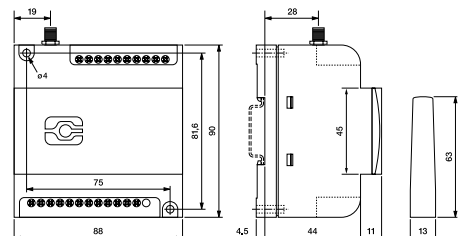
**Product references**

Types	Product reference	12-48
DC supply	CMS-10ADF/DC...V	✓
DC supply, kit (*included accessories)	CMS-10ADFKIT/DC...V	✓

"..." list control circuit voltage to complete product references.

**Accessories**

Antennas	CMS-ANT-SPEZ/5M, CMS-ANT-MAG/2.5M*
Antenna cables	CMS-ANT-KAB/5M, CMS-ANT-KAB/10M, CMS-ANT-KAB/20M
Programming cable	CMS-RS232*
USB to serial converter	CMS-USB*
Power supply 15W, 24V	DR-15-24
Power supply 30W, 24V	DR-30-24
PT100 / PT1000 amplifier	MV-LKM-274
Indoor temperature sensor with display, 0 ... 50 °C	CRF01-U-D
Indor temperature sensor, 0 ... 50 °C	CRF01-U
Exterior temperature sensor, -50 ... +50 °C	CWF50-EXT-U4
Thermostat, 5 ... 30 °C	CRTBSB-001-010
Temperature / humidity sensor	KS-110
Water level sensor	PS1

**fig. 1. Wiring diagram****fig. 2. Dimensions (mm)****Standards and approvals**

Standards IEC/EN 60947, IEC/EN60730

Approvals 

**CMS-10ACDF****4 analogue / digital inputs | 2 inputs 4 ... 20 mA | 4 relay outputs | 12 ... 48 V DC****Power supply**

Nominal voltage	12 ... 48 V DC
Operating voltage range	10 ... 60 V DC
Power consumption AC/DC	4.2 W

**Inputs**

Number of analogue inputs	2
Number of analogue / digital inputs	4
Nominal voltage digital inputs	12 ... 48 V DC
Nominal range analogue inputs	0 ... 10 V (I1 - I4) / 4 ... 20 mA (I5 - I6)
Resolution of analogue inputs	10 Bit

**Outputs**

Number of relay outputs	4
Contact Material	⚡ AgNi
Rated voltage	250 V AC
Rated current	10 A
Minimum contact load relay outputs	10 mA, 12V
Inrush current	15 A, 20 ms
Rated load AC-1	2500 VA
Mechanical endurance	3 x 10 <sup>7</sup>
Electrical endurance at rated load AC-1	150 000

**Communication**

Communication standards	GSM
Frequencies	850 / 900 / 1800 / 1900 MHz
Antenna connector	SMA female

**Insulation**

Rated test voltage control / main circuit	2.5 kV, 1 min
Rated test voltage main / main circuit	2.5 kV, 1 min
Pollution degree	3
Overvoltage category	II

**General data**

Ambient temperature storage	-40 ... 85 °C
Ambient temperature operation	-25 ... 55 °C
Conductor cross section	2.5 mm <sup>2</sup>
Nominal screw torque	0.5 Nm
Weight	120 g
Protection degree	IP20
Housing material	PC

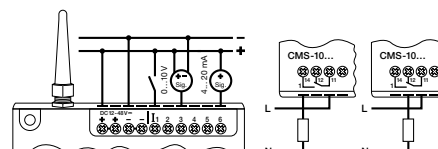
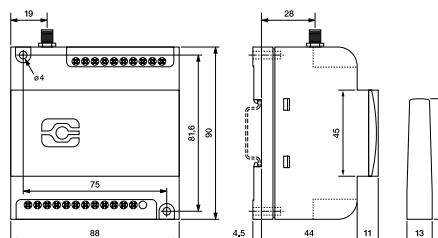
**Product references**

Types	Product reference	12-48
DC supply	CMS-10ACDF/DC...V	✓
DC supply, kit (*included accessories)	CMS-10ACDFKIT/DC...V	✓

"..." list control circuit voltage to complete product references.

**Accessories**

Antennas	CMS-ANT-SPEZ/5M, CMS-ANT-MAG/2.5M*
Antenna cables	CMS-ANT-KAB/5M, CMS-ANT-KAB/10M, CMS-ANT-KAB/20M
Programming cable	CMS-RS232*
USB to serial converter	CMS-USB*
Power supply 15W, 24V	DR-15-24
Power supply 30W, 24V	DR-30-24
PT100 / PT1000 amplifier	MV-LKM-274
Indoor temperature sensor with display, 0 ... 50 °C	CRF01-U-D
Indoor temperature sensor, 0 ... 50 °C	CRF01-U
Exterior temperature sensor, -50 ... +50 °C	CWF50-EXT-U4
Thermostat, 5 ... 30 °C	CRTBSB-001-010
Temperature / humidity sensor	KS-110
Water level sensor	PS1

**fig. 1. Wiring diagram****fig. 2. Dimensions (mm)****Standards and approvals**

Standards IEC/EN 60947, IEC/EN60730

Approvals 

## 5.2 CMS Accessories

Application	Type	Page
<b>Accessories</b>		
Exterior antenna   5 m cable	CMS-ANT-SPEZ/5M	312
Magnetic pod antenna   2.5 m cable	CMS-ANT-MAG/2.5M	313
Antenna cable   SMA male / female   5 m   10 m   20 m	CMS-ANT-KAB	314
Programming cable   Serial 1:1   D-Sub 9 male / female   2 m	CMS-RS232	315
USB to serial converter   D-Sub 9 to USB A   FTDI FT231XS	CMS-USB	316
Power supply   24 V DC   15 W   30 W	DR-15-24, DR-30-24	317
PT100 / PT1000 amplifier   0 ... 10 V output	MV-LKM-274	318
Indoor temperature sensor   0 ... 50 °C   0 ... 10 V output	RF01-U, RF01-U-D2	319
Thermostat   5 ... 30 °C   Cooling or heating   1 CO	RTBSB-001-010	320
Exterior temperature sensor   -50 ... 50 °C   0 ... 10 V output	WF50-EXT-U4	321
Temperature / humidity sensor   -40 ... 80 °C   0 ... 100 % rH   0 ... 10 V output   Cable length 2 m	KS-110	322
Water level sensor   0 ... 0.5 bar   0 ... 10 V output	PS1	323

**CMS-ANT-SPEZ/5M****Exterior antenna | 5 m cable****Communication**

Communication standards	GSM
Frequencies	824 ... 960 / 1710 ... 1990 MHz
Antenna connector	SMA male
Antenna type	1/4 _
Impedance	50 Ω
Max. power	20 W

**General data**

Ambient temperature storage	-30 °C ... 70 °C
Ambient temperature operation	-20 °C ... 60 °C
Weight	360 g
Housing material	RW24BR

**Product references**

Types	Product reference	5
Exterior antenna	CMS-ANT-SPEZ/...M	✓

"..." list cable length to complete product references.

**Standards and approvals**

Approvals





## CMS-ANT-MAG/2.5M

### Magnetic pod antenna | 2.5 m cable

#### Communication

Communication standards	GSM / UMTS
Frequencies	824 / 960 / 1710 / 1910 / 1990 / 2010 / 2025 / 2110 / 2170 MHz
Antenna connector	SMA male
Antenna type	1/4 _
Impedance	50 $\Omega$
Max. power	20 W



#### General data

Ambient temperature storage	-40 °C ... 80 °C
Ambient temperature operation	-40 °C ... 80 °C
Weight	65 g
Housing material	PA 6

#### Product references

Types	Product reference	2.5
Magnetic pod antenna	CMS-ANT-MAG/...M	✓

"..." list cable length to complete product references.

#### Standards and approvals

Approvals



**CMS-ANT-KAB****Antenna cable | SMA male / female | 5 m | 10 m | 20 m****Communication**

Antenna connector	SMA male / female
Impedance	50 Ω

**General data**

Ambient temperature storage	-35 °C ... 80 °C
Ambient temperature operation	-35 °C ... 80 °C
Weight	180 g ( 5 m) / 270 g (10 m) / 728 g (20 m)
Housing material	Cu / PE

**Product references**

Types	Product reference	5	10	20
Extension cable SMA male / female	CMS-ANT-KAB/...M	✓	✓	✓

"..." list cable length to complete product references.

Other cable length on request. Please contact [support@comatreleco.com](mailto:support@comatreleco.com).

**Standards and approvals**

Approvals



**CMS-RS232****Programming cable | Serial 1:1 | D-Sub 9 male / female | 2 m****General data**

Ambient temperature storage	-35 °C ... 80 °C
Ambient temperature operation	-35 °C ... 80 °C
Weight	126 g

**Product references**

Types	Product reference
Programming cable	CMS-RS232

**Standards and approvals**

Approvals



## CMS-USB

### USB to serial converter | D-Sub 9 to USB A | FTDI FT231XS

#### General data

Ambient temperature storage	-40 °C ... 85 °C
Ambient temperature operation	-40 °C ... 85 °C
Weight	41 g



#### Product references

Types	Product reference
USB to serial converter	CMS-USB

#### Standards and approvals

Approvals



**DR-15-24, DR-30-24****Power supply | 24 V DC | 15 W | 30 W****Power supply**

Nominal voltage	230 V AC
Operating voltage range	85 ... 264 V AC
Power consumption AC/DC	- / 110 VA
Rated frequency	47 ... 63 Hz
Output voltage	24 V DC
Output voltage range	21.6 ... 26.4 V
Output power	15 W      30 W

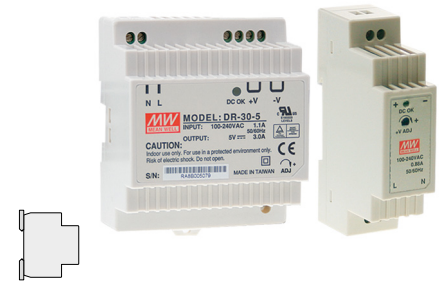
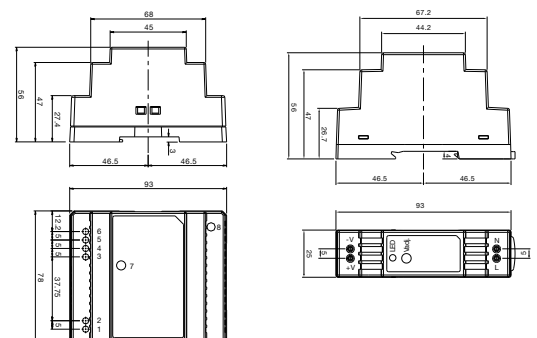
**General data**

Ambient temperature storage	-40 °C ... 85 °C
Ambient temperature operation	-20 °C ... 60 °C
Conductor cross section	2.5 mm <sup>2</sup>
Module width	fig. 1
Weight	65 g
Protection degree	IP20
Housing material	PA 6

**Product references**

Types	Product reference
Power supply 15 W, 24 V DC	DR-15-24
Power supply 30 W, 24 V DC	DR-30-24

Other voltages on request. Please contact [support@comatreleco.com](mailto:support@comatreleco.com).

**fig. 1. Dimensions (mm)****Standards and approvals**

Approvals



**MV-LKM-274****PT100 / PT1000 amplifier | 0 ... 10 V output****Power supply**

Nominal voltage	24 V DC
Operating voltage range	15 ... 35 V DC
Power consumption AC/DC	0.24 W / -

**Outputs**

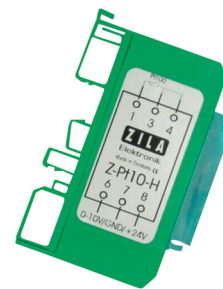
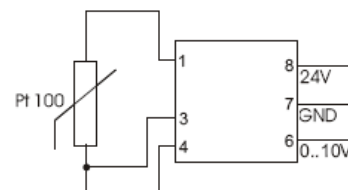
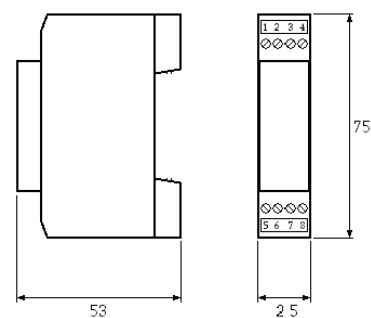
Number of analogue outputs	1
Analogue output type	0 ... 10 V

**General data**

Ambient temperature storage	-25 °C ... 70 °C
Ambient temperature operation	-25 °C ... 70 °C
Conductor cross section	2.5 mm <sup>2</sup>
Module width	fig. 2
Weight	60 g
Protection degree	IP20
Housing material	PC

**Product references**

Types	Product reference
PT100 / PT1000 amplifier	MV-LKM-274

**fig. 1. Wiring diagram****fig. 2. Dimensions (mm)****Standards and approvals**

Approvals



**RF01-U, RF01-U-D2****Indoor temperature sensor | 0 ... 50 °C | 0 ... 10 V output****Power supply**

Nominal voltage	24 V UC
Operating voltage range	22 ... 26 V UC
Power consumption AC/DC	0.2 W / -

**Outputs**

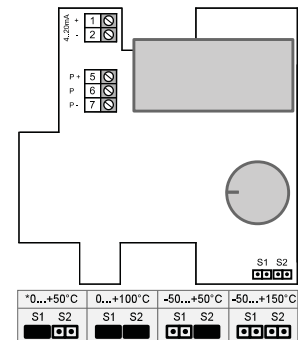
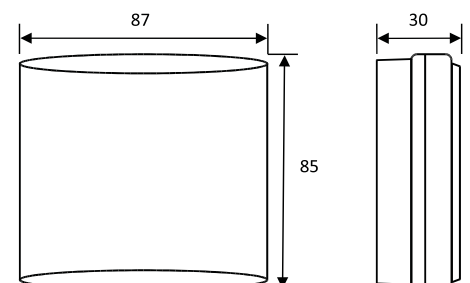
Number of analogue outputs	1
Analogue output type	0 ... 10 V

**General data**

Ambient temperature storage	-20 °C ... 60 °C
Ambient temperature operation	-20 °C ... 60 °C
Conductor cross section	1.5 mm <sup>2</sup>
Module width	fig. 2
Weight	67 g
Protection degree	IP54
Housing material	ABS

**Product references**

Types	Product reference
Indoor temperature sensor	RF01-U
Indoor temperature sensor with display	RF01-U-D2

**fig. 1. Wiring diagram****fig. 2. Dimensions (mm)****Standards and approvals**

Approvals



**RTBSB-001-010****Thermostat | 5 ... 30 °C | Cooling or heating | 1 CO****Outputs**

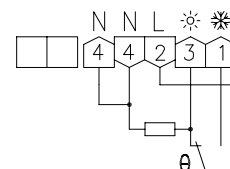
Number of relay outputs	1 CO
Rated voltage	230 V AC
Rated current	10 A (Terminal 1) / 5 A (Terminal 3)
Rated load AC-1	2300 VA / 1150 VA

**General data**

Ambient temperature storage	-20 °C ... 60 °C
Ambient temperature operation	-20 °C ... 60 °C
Conductor cross section	1.5 mm <sup>2</sup>
Weight	90 g
Protection degree	IP30
Housing material	ABS

**Product references**

Types	Product reference
Thermostat	RTBSB-001-010

**fig. 1. Wiring diagram****Standards and approvals**

Approvals





**WF50-EXT-U4****Exterior temperature sensor | -50 ... 50 °C | 0 ... 10 V output****Power supply**

Nominal voltage	24 V DC
Operating voltage range	21.6 ... 26.4 V DC

**Outputs**

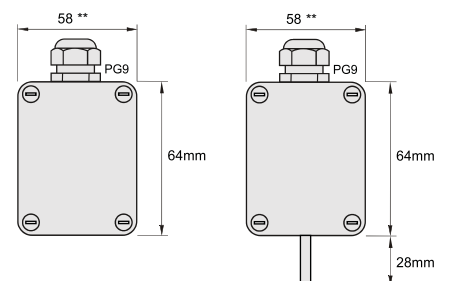
Number of analogue outputs	1
Analogue output type	0 ... 10 V

**General data**

Ambient temperature storage	-30 °C ... 70 °C
Ambient temperature operation	-30 °C ... 70 °C
Conductor cross section	1.5 mm <sup>2</sup>
Module width	fig. 2
Weight	100 g
Protection degree	IP65
Housing material	PA

**Product references**

Types	Product reference
Exterior temperature sensor	WF50-EXT-U4

**fig. 2. Dimensions (mm)****Standards and approvals**

Approvals



**KS-110**
**Temperature / humidity sensor | -40 ... 80 °C | 0 ... 100 % rH | 0 ... 10 V output | Cable length 2 m**
**Power supply**

Nominal voltage	24 V DC
Operating voltage range	12 ... 27 V DC
Power consumption AC/DC	0.2 W / -

**Outputs**

Number of analogue outputs	2
Analogue output type	0 ... 10 V

**General data**

Ambient temperature storage	-40 °C ... 85 °C
Ambient temperature operation	-40 °C ... 85 °C
Weight	62 g
Protection degree	IP65

**Product references**

Types	Product reference
Temperature / humidity sensor	KS-110


**Standards and approvals**

Approvals



## PS1

### Water level sensor | 0 ... 0.5 bar | 0 ... 10 V output

#### Power supply

Nominal voltage	24 V DC
Operating voltage range	12 ... 30 V DC

#### Outputs

Number of analogue outputs	1
Analogue output type	0 ... 10 V

#### General data

Ambient temperature storage	5 °C ... 70 °C
Ambient temperature operation	5 °C ... 70 °C
Weight	550 g
Protection degree	IP68

#### Product references

Types	Product reference
Water level sensor	PS1

*Sensors for other liquids on request. Please contact [support@comatreleco.com](mailto:support@comatreleco.com).*



#### Standards and approvals

Approvals





## 6 Softstarter

---



## 6.1 Softstarter

Application	Type	Page
<b>CTC Series</b>		
Starting Torque Limiter   3 phase   400 V   15 A	CTC3415	328
Starting Torque Limiter   3 phase   400 V   25 A	CTC3425	329
<b>CCL Series</b>		
Compressor Starting Torque Limiter   3 phase   400 V   15 A	CCL33H415US	330
Compressor Starting Torque Limiter   3 phase   400 V   25 A	CCL33H425US	331
Compressor Starting Torque Limiter   3 phase   400 V   35 A	CCL33H435US	332
<b>CCM Series</b>		
Starting Torque Limiter   3 phase   400 V   3 A	CCM3H403USi	333
Starting Torque Limiter   3 phase   400 V   15 A	CCM3H415	334
Starting Torque Limiter   3 phase   400 V   15 A	CCM3H415DS	335
Starting Torque Limiter   3 phase   400 V   25 A	CCM3H425	336
Starting Torque Limiter   3 phase   480 V   25 A	CCM33H425US	337
Starting Torque Limiter   3 phase   480 V   50 A	CCM33H450US	338
Starting Torque Limiter   3 phase   480 V   30 A	CCM33H530USi	339
Starting Torque Limiter   3 phase   480 V   50 A	CCM33H550USi	340
Starting Torque Limiter with dynamic brake   3 phase   400 V   25 A	CCMB3H425	341
<b>Accessories</b>		
Thermal overload protection	P82-100C	342

**CTC3415**

**Starting Torque Limiter | 3 phase | 400 V | 15 A**

**Main circuit**

Number of outputs	3
Controlled phases	1
Output type	⚡ Thyristor
Rated voltage	400 V
Output voltage range	208 ... 400 V AC
Reverse voltage	1200 V <sub>rrm</sub>
Peak reverse voltage	1300 V <sub>rrm</sub>
Rated current AC-53a	15 A
Minimum load	50 mA
Typ. leakage current	5 mA
Rated limit load	1800 A <sup>2</sup> t
Switching cycles / h	3000

**Control circuit**

Release time	1 Periode
Ramp-up time	0.5 ... 5 s
Torque adjustment	0 ... 85 %
Rated frequency	50 / 60 Hz

**Insulation**

Rated insulation voltage	660 V
Rated impulse withstand voltage	4 kV
Pollution degree	3
Overvoltage category	III

**General data**

Ambient temperature storage	-20 ... 80 °C
Ambient temperature operation	-5 ... 40 °C
Ambient temperature operation derated power	-5 ... 60 °C, 0.7 I <sub>n</sub>
Conductor cross section Control / Main Circuit	1.5 mm <sup>2</sup> / 4 mm <sup>2</sup>
Nominal screw torque Control / Main Circuit	0.5 Nm / 1.2 Nm
Module width	fig. 2
Weight	650 g
Protection degree	IP 20
Housing material	PPO
Mounting	TS 35 or Back Panel Mounting

**Product references**

Description	Product reference
Starting Torque Limiter, 3 phase	CTC3415

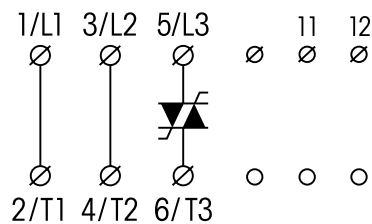
Other devices on request. Please contact [support@comatreleco.com](mailto:support@comatreleco.com).

**Accessories**

Thermostat	P82-100C
------------	----------

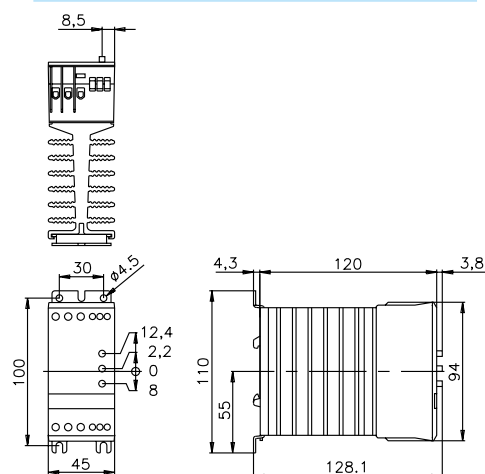


**fig. 1. Wiring diagram**



11-12: Thermostat

**fig. 2. Dimensions (mm)**



**Standards and approvals**

Standards IEC/EN 60947, 60068-2-6

Approvals



**Main circuit**

Number of outputs	3
Controlled phases	1
Output type	Thyristor
Rated voltage	400 V
Output voltage range	208 ... 400 V AC
Reverse voltage	1200 V <sub>rrm</sub>
Peak reverse voltage	1300 V <sub>rrm</sub>
Rated current AC-53a	25 A
Minimum load	50 mA
Typ. leakage current	5 mA
Rated limit load	6300 A <sup>2</sup> t
Switching cycles / h	3000

**Control circuit**

Release time	1 Periode
Ramp-up time	0.5 ... 5 s
Torque adjustment	0 ... 85 %
Rated frequency	50 / 60 Hz

**Insulation**

Rated insulation voltage	660 V
Rated impulse withstand voltage	4 kV
Pollution degree	3
Overvoltage category	III

**General data**

Ambient temperature storage	-20 ... 80 °C
Ambient temperature operation	-5 ... 40 °C
Ambient temperature operation derated power	-5 ... 60 °C, 0.7 I <sub>n</sub>
Conductor cross section Control / Main Circuit	1.5 mm <sup>2</sup> / 4 mm <sup>2</sup>
Nominal screw torque Control / Main Circuit	0.5 Nm / 1.2 Nm
Module width	fig. 2
Weight	650 g
Protection degree	IP 20
Housing material	PPO
Mounting	TS 35 or Back Panel Mounting

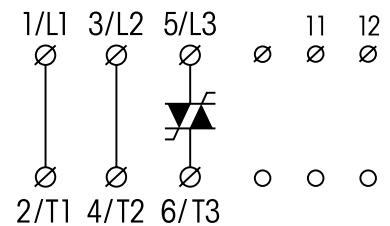
**Product references**

Description	Product reference
Starting Torque Limiter, 3 phase	CTC3425

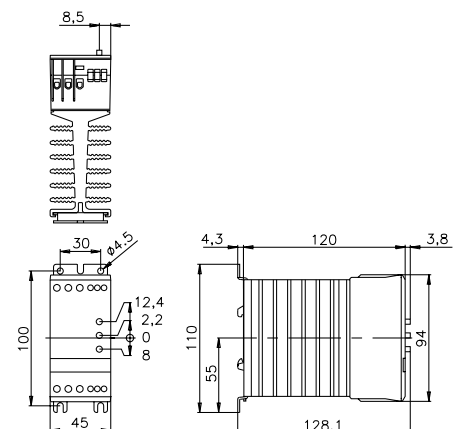
Other devices on request. Please contact [support@comatreleco.com](mailto:support@comatreleco.com).

**Accessories**

Thermostat	P82-100C
------------	----------

**fig. 1. Wiring diagram**

11-12: Thermostat

**fig. 2. Dimensions (mm)****Standards and approvals**

Standards IEC/EN 60947, 60068-2-6

Approvals

**CCL33H415US****Compressor Starting Torque Limiter | 3 phase | 400 V | 15 A****Main circuit**

Number of outputs	3
Controlled phases	3
Output type	Thyristor
Bypass	Integrated
Rated voltage	400 V
Output voltage range	230 ... 400 V AC
Reverse voltage	1200 V <sub>rrm</sub>
Peak reverse voltage	1300 V <sub>rrm</sub>
Rated current AC-58	15 A
Minimum load	1.5 A
Typ. leakage current	5 mA
Inrush current	90 A, 1 s
Rated limit load	610 A <sup>2</sup> t
Switching cycles / h	12

**Control circuit**

Nominal voltage	230 V AC
Operating voltage range	0.85 ... 1.15 U <sub>N</sub>
Typ. release voltage	110 V AC
Pick-up time	500 ms
Release time	500 ms

**Insulation**

Rated insulation voltage	660 V
Rated impulse withstand voltage	4 kV
Pollution degree	3
Overvoltage category	III

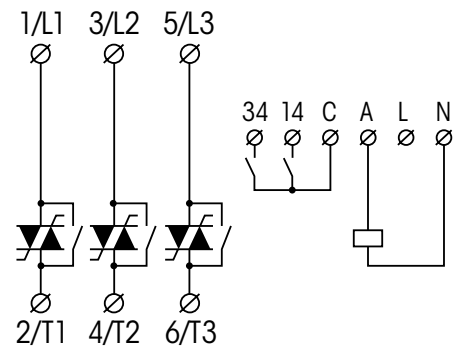
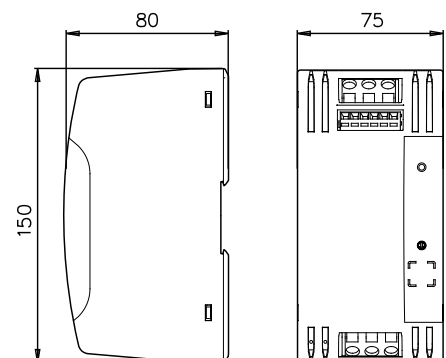
**General data**

Ambient temperature storage	-20 ... 80 °C
Ambient temperature operation	-20 ... 65 °C
Conductor cross section Control / Main Circuit	2.5 mm <sup>2</sup> / 6 mm <sup>2</sup>
Module width	fig. 2
Weight	470 g
Protection degree	IP 20
Housing material	PPE
Mounting	TS 35 or Back Panel Mounting

**Product references**

Description	Product reference
Compressor Starting Torque Limiter, 3 phase	CCL33H415US

Other devices on request. Please contact [support@comatreleco.com](mailto:support@comatreleco.com).

**fig. 1. Wiring diagram****fig. 2. Dimensions (mm)****Standards and approvals**

Standards IEC/EN 60947

Approvals

**Main circuit**

Number of outputs	3
Controlled phases	3
Output type	⚡ Thyristor
Bypass	Integrated
Rated voltage	400 V
Output voltage range	230 ... 400 V AC
Reverse voltage	1200 V <sub>rrm</sub>
Peak reverse voltage	1300 V <sub>rrm</sub>
Rated current AC-58	25 A
Minimum load	2.5 A
Typ. leakage current	5 mA
Inrush current	150 A, 1 s
Rated limit load	1800 A <sup>2</sup> t
Switching cycles / h	12

**Control circuit**

Nominal voltage	230 V AC
Operating voltage range	0.85 ... 1.15 U <sub>N</sub>
Typ. release voltage	110 V AC
Pick-up time	500 ms
Release time	500 ms

**Insulation**

Rated insulation voltage	660 V
Rated impulse withstand voltage	4 kV
Pollution degree	3
Overvoltage category	III

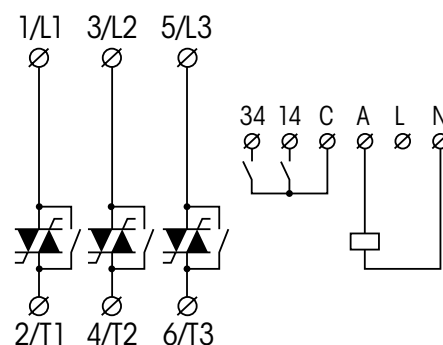
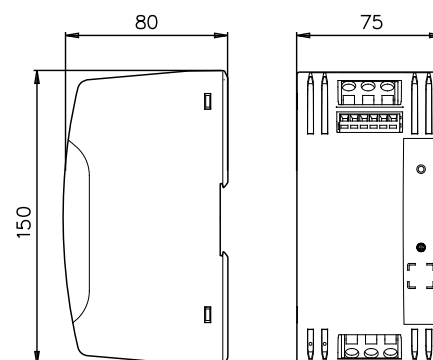
**General data**

Ambient temperature storage	-20 ... 80 °C
Ambient temperature operation	-20 ... 65 °C
Conductor cross section Control / Main Circuit	2.5 mm <sup>2</sup> / 6 mm <sup>2</sup>
Module width	fig. 2
Weight	470 g
Protection degree	IP 20
Housing material	PPE
Mounting	TS 35 or Back Panel Mounting

**Product references**

Description	Product reference
Compressor Starting Torque Limiter, 3 phase	CCL33H425US

Other devices on request. Please contact [support@comatreleco.com](mailto:support@comatreleco.com).

**fig. 1. Wiring diagram****fig. 2. Dimensions (mm)****Standards and approvals**

Standards IEC/EN 60947

Approvals CE cULus

**CCL33H435US****Compressor Starting Torque Limiter | 3 phase | 400 V | 35 A****Main circuit**

Number of outputs	3
Controlled phases	3
Output type	Thyristor
Bypass	Integrated
Rated voltage	400 V
Output voltage range	230 ... 400 V AC
Reverse voltage	1200 V <sub>rrm</sub>
Peak reverse voltage	1300 V <sub>rrm</sub>
Rated current AC-58	35 A
Minimum load	3.5 A
Typ. leakage current	5 mA
Inrush current	210 A, 1 s
Rated limit load	1800 A <sup>2</sup> t
Switching cycles / h	12

**Control circuit**

Nominal voltage	230 V AC
Operating voltage range	0.85 ... 1.15 U <sub>N</sub>
Typ. release voltage	110 V AC
Pick-up time	500 ms
Release time	500 ms

**Insulation**

Rated insulation voltage	660 V
Rated impulse withstand voltage	4 kV
Pollution degree	3
Overvoltage category	III

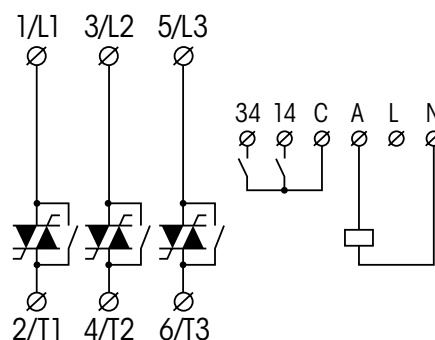
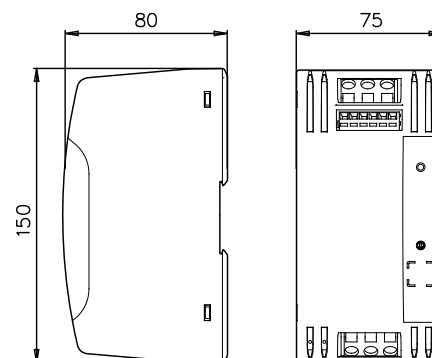
**General data**

Ambient temperature storage	-20 ... 80 °C
Ambient temperature operation	-20 ... 65 °C
Conductor cross section Control / Main Circuit	2.5 mm <sup>2</sup> / 6 mm <sup>2</sup>
Module width	fig. 2
Weight	470 g
Protection degree	IP 20
Housing material	PPE
Mounting	TS 35 or Back Panel Mounting

**Product references**

Description	Product reference
Compressor Starting Torque Limiter, 3 phase	CCL33H435US

Other devices on request. Please contact [support@comatreleco.com](mailto:support@comatreleco.com).

**fig. 1. Wiring diagram****fig. 2. Dimensions (mm)****Standards and approvals**

Standards IEC/EN 60947

Approvals  

**Main circuit**

Number of outputs	3
Controlled phases	2
Output type	Thyristor
Bypass	Integrated
Rated voltage	400 V
Output voltage range	400 ... 480 V AC
Reverse voltage	1200 V <sub>rrm</sub>
Peak reverse voltage	1300 V <sub>rrm</sub>
Rated current AC-53b	3 A
Minimum load	250 mA
Typ. leakage current	5 mA
Inrush current	18 A
Rated limit load	72 A <sup>2</sup> t
Switching cycles / h	120

**Control circuit**

Nominal voltage	400 V AC
Ramp-up time	0.5 ... 10 s
Ramp-down time	0.5 ... 10 s
Torque adjustment	0 ... 85 %
Rated frequency	50 / 60 Hz

**Insulation**

Rated insulation voltage	660 V
Rated impulse withstand voltage	4 kV
Pollution degree	3
Overvoltage category	III

**General data**

Ambient temperature storage	-20 ... 80 °C
Ambient temperature operation	-5 ... 40 °C
Ambient temperature operation derated power	-5 ... 60 °C
Conductor cross section Control / Main Circuit	2.5 mm <sup>2</sup> / 4 mm <sup>2</sup>
Nominal screw torque Control / Main Circuit	0.5 Nm / 1.2 Nm
Module width	fig. 2
Weight	270 g
Protection degree	IP 20
Housing material	PPO
Mounting	TS 35 or Back Panel Mounting

**Product references**

Description	Product reference
Starting Torque Limiter, 3 phase	CCM3H403USi

Other devices on request. Please contact [support@comatreleco.com](mailto:support@comatreleco.com).



fig. 1. Wiring diagram

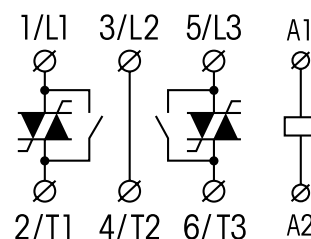
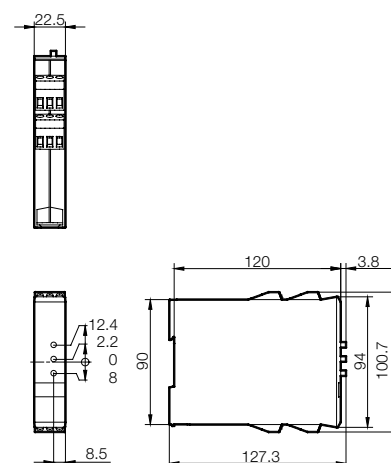


fig. 2. Dimensions (mm)

**Standards and approvals**

Standards IEC/EN 60947, 60068

Approvals

**CCM3H415****Starting Torque Limiter | 3 phase | 400 V | 15 A****Main circuit**

Number of outputs	3
Controlled phases	2
Output type	⚡ Thyristor
Rated voltage	400 V
Output voltage range	400 ... 480 V AC
Reverse voltage	1200 V <sub>rrm</sub>
Peak reverse voltage	1300 V <sub>rrm</sub>
Rated current AC-53b	15 A
Minimum load	250 mA
Typ. leakage current	5 mA
Inrush current	90 A
Rated limit load	1800 A <sup>2</sup> t
Switching cycles / h	3000

**Control circuit**

Nominal voltage	400 V AC
Ramp-up time	0.5 ... 10 s
Ramp-down time	0.5 ... 10 s
Torque adjustment	0 ... 85 %
Rated frequency	50 / 60 Hz

**Insulation**

Rated insulation voltage	660 V
Rated impulse withstand voltage	4 kV
Pollution degree	3
Overvoltage category	III

**General data**

Ambient temperature storage	-20 ... 80 °C
Ambient temperature operation	-5 ... 40 °C
Ambient temperature operation derated power	-5 ... 60 °C
Conductor cross section Control / Main Circuit	2.5 mm <sup>2</sup> / 4 mm <sup>2</sup>
Nominal screw torque Control / Main Circuit	0.5 Nm / 1.2 Nm
Module width	fig. 2
Weight	650 g
Protection degree	IP 20
Housing material	PPO
Mounting	TS 35 or Back Panel Mounting

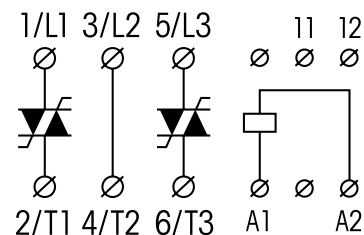
**Product references**

Description	Product reference
Starting Torque Limiter, 3 phase	CCM3H415

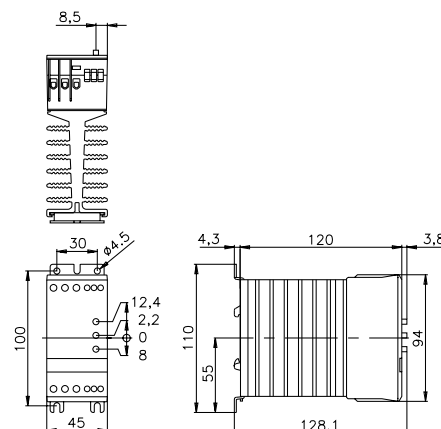
Other devices on request. Please contact [support@comatreleco.com](mailto:support@comatreleco.com).

**Accessories**



Thermal overload protection	P82-100C
-----------------------------	----------

**fig. 1. Wiring diagram**

11-12: Thermostat

**fig. 2. Dimensions (mm)****Standards and approvals**

Standards IEC/EN 60947, 60068

Approvals  

## 6.1 Softstarter

### CCM3H415DS

Starting Torque Limiter | 3 phase | 400 V | 15 A

#### Main circuit

Number of outputs	3
Controlled phases	2
Output type	Thyristor
Rated voltage	400 V
Output voltage range	400 ... 480 V AC
Reverse voltage	1200 V <sub>rrm</sub>
Peak reverse voltage	1300 V <sub>rrm</sub>
Rated current AC-53b	15 A
Minimum load	250 mA
Typ. leakage current	5 mA
Inrush current	90 A
Rated limit load	1800 A <sup>2</sup> t
Switching cycles / h	3000

#### Control circuit

Nominal voltage	400 V AC
Ramp-up time	0.5 ... 10 s
Ramp-down time	0.5 ... 10 s
Torque adjustment	0 ... 85 %
Rated frequency	50 / 60 Hz

#### Insulation

Rated insulation voltage	660 V
Rated impulse withstand voltage	4 kV
Pollution degree	3
Overvoltage category	III

#### General data

Ambient temperature storage	-20 ... 80 °C
Ambient temperature operation	-5 ... 40 °C
Ambient temperature operation derated power	-5 ... 60 °C
Conductor cross section Control / Main Circuit	2.5 mm <sup>2</sup> / 4 mm <sup>2</sup>
Nominal screw torque Control / Main Circuit	0.5 Nm / 1.2 Nm
Module width	fig. 2
Weight	650 g
Protection degree	IP 20
Housing material	PPO
Mounting	TS 35 or Back Panel Mounting

#### Product references

Description	Product reference
Starting Torque Limiter, 3 phase	CCM3H415DS

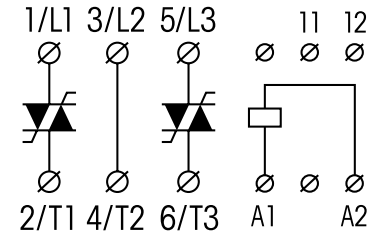
Other devices on request. Please contact [support@comatreleco.com](mailto:support@comatreleco.com).

#### Accessories

Thermal overload protection	P82-100C
-----------------------------	----------

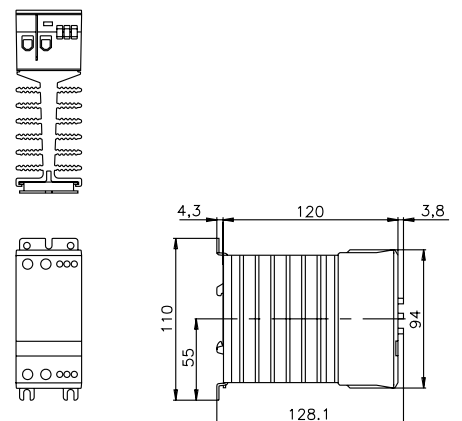


fig. 1. Wiring diagram



11-12: Thermostat

fig. 2. Dimensions (mm)



#### Standards and approvals

Standards IEC/EN 60947, 60068

Approvals

**CCM3H425****Starting Torque Limiter | 3 phase | 400 V | 25 A****Main circuit**

Number of outputs	3
Controlled phases	2
Output type	⚡ Thyristor
Rated voltage	400 V
Output voltage range	400 ... 480 V AC
Reverse voltage	1200 V <sub>rrm</sub>
Peak reverse voltage	1300 V <sub>rrm</sub>
Rated current AC-53b	25 A
Minimum load	250 mA
Typ. leakage current	5 mA
Inrush current	150 A
Rated limit load	6300 A <sup>2</sup> t
Switching cycles / h	3000

**Control circuit**

Nominal voltage	400 V AC
Ramp-up time	0.5 ... 10 s
Ramp-down time	0.5 ... 10 s
Torque adjustment	0 ... 85 %
Rated frequency	50 / 60 Hz

**Insulation**

Rated insulation voltage	660 V
Rated impulse withstand voltage	4 kV
Pollution degree	3
Overvoltage category	III

**General data**

Ambient temperature storage	-20 ... 80 °C
Ambient temperature operation	-5 ... 40 °C
Ambient temperature operation derated power	-5 ... 60 °C
Conductor cross section Control / Main Circuit	2.5 mm <sup>2</sup> / 6 mm <sup>2</sup>
Nominal screw torque Control / Main Circuit	0.5 Nm / 1.2 Nm
Module width	fig. 2
Weight	1050 g
Protection degree	IP 20
Housing material	PPO
Mounting	TS 35 or Back Panel Mounting

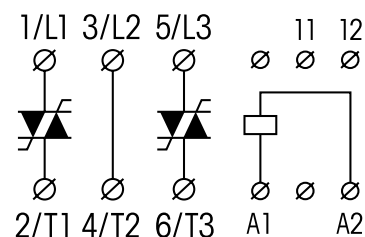
**Product references**

Description	Product reference
Starting Torque Limiter, 3 phase	CCM3H425

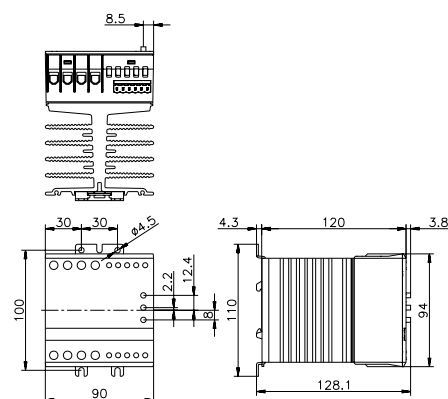
Other devices on request. Please contact [support@comatreleco.com](mailto:support@comatreleco.com).

**Accessories**

Thermal overload protection	P82-100C
-----------------------------	----------

**fig. 1. Wiring diagram**

11-12: Thermostat

**fig. 2. Dimensions (mm)****Standards and approvals**

Standards IEC/EN 60947, 60068

Approvals



## 6.1 Softstarter CCM33H425US

Starting Torque Limiter | 3 phase | 480 V | 25 A

### Main circuit

Number of outputs	3
Controlled phases	3
Output type	Thyristor
Bypass	Externally
Rated voltage	400 V
Output voltage range	200 ... 480 V AC
Reverse voltage	1200 V <sub>rrm</sub>
Peak reverse voltage	1300 V <sub>rrm</sub>
Rated current AC-53b	25 A
Minimum load	3 A
Typ. leakage current	5 mA
Inrush current	150 A, 450 ms
Rated limit load	6300 A <sup>2</sup> t
Switching cycles / h	120

### Control circuit

Nominal voltage	480 V AC
Operating voltage range	24 - 230 V UC
Typ. release voltage	5 V UC
Ramp-up time	0.5 ... 30 s
Ramp-down time	0.5 ... 60 s
Torque adjustment	0 ... 85 %
Rated frequency	50 / 60 Hz

### Insulation

Rated insulation voltage	660 V
Rated impulse withstand voltage	4 kV
Pollution degree	3
Overvoltage category	III

### General data

Ambient temperature storage	-20 ... 80 °C
Ambient temperature operation	-5 ... 40 °C
Ambient temperature operation derated power	-5 ... 60 °C
Conductor cross section Control / Main Circuit	2.5 mm <sup>2</sup> / 6 mm <sup>2</sup>
Nominal screw torque Control / Main Circuit	0.5 Nm / 1.2 Nm
Module width	fig. 2
Weight	1050 g
Protection degree	IP 20
Housing material	PPE
Mounting	TS 35 or Back Panel Mounting

### Product references

Description	Product reference
Starting Torque Limiter, 3 phase	CCM33H425US

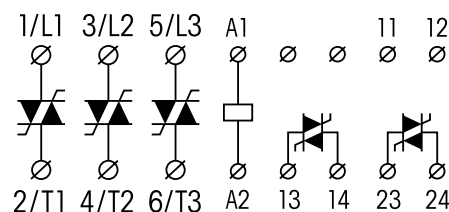
Other devices on request. Please contact [support@comatreleco.com](mailto:support@comatreleco.com).

### Accessories

Thermal overload protection	P82-100C
-----------------------------	----------

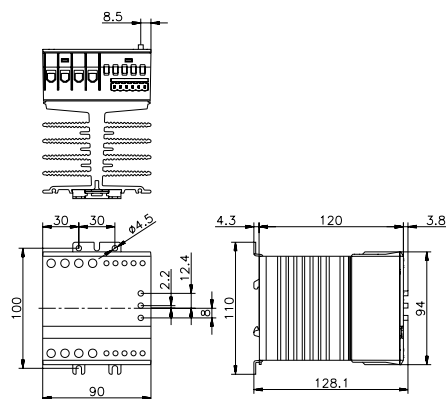


fig. 1. Wiring diagram



11-12: Thermostat  
13-14: For control of Start/Stop function  
23-24: By end of ramp up time for by-pass contactor

fig. 2. Dimensions (mm)



### Standards and approvals

Standards IEC/EN 60947, 50022, 60068

Approvals

**CCM33H450US****Starting Torque Limiter | 3 phase | 480 V | 50 A****Main circuit**

Number of outputs	3
Controlled phases	3
Output type	⚡ Thyristor
Bypass	Externally
Rated voltage	400 V
Output voltage range	200 ... 480 V AC
Reverse voltage	1200 V <sub>rrm</sub>
Peak reverse voltage	1300 V <sub>rrm</sub>
Rated current AC-53b	50 A
Minimum load	3 A
Typ. leakage current	5 mA
Inrush current	300 A, 450 ms
Rated limit load	25300 A <sup>2</sup> t
Switching cycles / h	120

**Control circuit**

Nominal voltage	480 V AC
Operating voltage range	24 - 230 V UC
Typ. release voltage	5 V UC
Ramp-up time	0.5 ... 30 s
Ramp-down time	0.5 ... 60 s
Torque adjustment	0 ... 85 %
Rated frequency	50 / 60 Hz

**Insulation**

Rated insulation voltage	660 V
Rated impulse withstand voltage	4 kV
Pollution degree	3
Overvoltage category	III

**General data**

Ambient temperature storage	-20 ... 80 °C
Ambient temperature operation	-5 ... 40 °C
Ambient temperature operation derated power	-5 ... 60 °C
Conductor cross section Control / Main Circuit	2.5 mm <sup>2</sup> / 6 mm <sup>2</sup>
Nominal screw torque Control / Main Circuit	0.5 Nm / 1.2 Nm
Module width	fig. 2
Weight	2500 g
Protection degree	IP 20
Housing material	PPE
Mounting	TS 35 or Back Panel Mounting

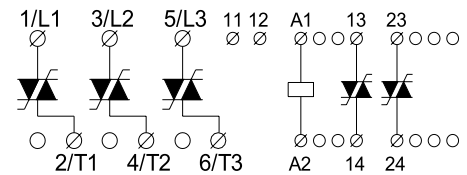
**Product references**

Description	Product reference
Starting Torque Limiter, 3 phase	CCM33H450US

Other devices on request. Please contact [support@comatreleco.com](mailto:support@comatreleco.com).

**Accessories**

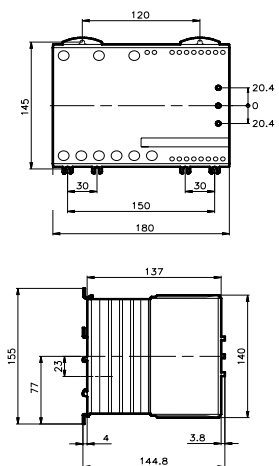
Thermal overload protection	P82-100C
-----------------------------	----------

**fig. 1. Wiring diagram**

11-12: Thermostat

13-14: For control of Start/Stop function

23-24: By end of ramp up time for by-pass contactor

**fig. 2. Dimensions (mm)****Standards and approvals**

Standards IEC/EN 60947, 50022, 60068

Approvals  

## 6.1 Softstarter

### CCM33H530USi

Starting Torque Limiter | 3 phase | 480 V | 30 A

#### Main circuit

Number of outputs	3
Controlled phases	3
Output type	Thyristor
Bypass	Externally
Rated voltage	400 V
Output voltage range	200 ... 480 V AC
Reverse voltage	1200 V <sub>rrm</sub>
Peak reverse voltage	1300 V <sub>rrm</sub>
Rated current AC-53b	30 A
Minimum load	3 A
Typ. leakage current	5 mA
Inrush current	180 A, 450 ms
Rated limit load	6300 A <sup>2</sup> t
Switching cycles / h	120

#### Control circuit

Nominal voltage	480 V AC
Operating voltage range	24 - 230 V UC
Typ. release voltage	5 V UC
Ramp-up time	0.5 ... 30 s
Ramp-down time	0.5 ... 60 s
Torque adjustment	0 ... 85 %
Rated frequency	50 / 60 Hz

#### Insulation

Rated insulation voltage	660 V
Rated impulse withstand voltage	4 kV
Pollution degree	3
Overvoltage category	III

#### General data

Ambient temperature storage	-20 ... 80 °C
Ambient temperature operation	-5 ... 40 °C
Ambient temperature operation derated power	-5 ... 60 °C
Conductor cross section Control / Main Circuit	2.5 mm <sup>2</sup> / 6 mm <sup>2</sup>
Nominal screw torque Control / Main Circuit	0.5 Nm / 1.2 Nm
Module width	fig. 2
Weight	1050 g
Protection degree	IP 20
Housing material	PPE
Mounting	TS 35 or Back Panel Mounting

#### Product references

Description	Product reference
Starting Torque Limiter, 3 phase	CCM33H530USi

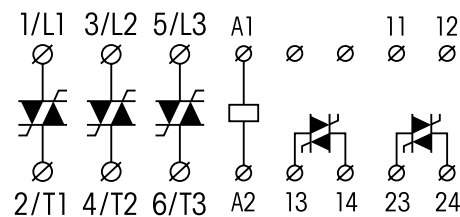
Other devices on request. Please contact [support@comatreleco.com](mailto:support@comatreleco.com).

#### Accessories

Thermal overload protection	P82-100C
-----------------------------	----------

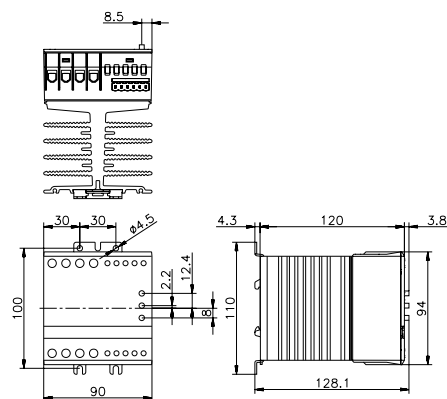


fig. 1. Wiring diagram



11-12: Thermostat  
 13-14: For control of Start/Stop function  
 23-24: By end of ramp up time for by-pass contactor

fig. 2. Dimensions (mm)



#### Standards and approvals

Standards IEC/EN 60947, 50022, 60068

Approvals

**CCM33H550USi****Starting Torque Limiter | 3 phase | 480 V | 50 A****Main circuit**

Number of outputs	3
Controlled phases	3
Output type	⚡ Thyristor
Bypass	Externally
Rated voltage	400 V
Output voltage range	200 ... 480 V AC
Reverse voltage	1200 V <sub>rrm</sub>
Peak reverse voltage	1300 V <sub>rrm</sub>
Rated current AC-53b	50 A
Minimum load	3 A
Typ. leakage current	5 mA
Inrush current	300 A, 450 ms
Rated limit load	25300 A <sup>2</sup> t
Switching cycles / h	120

**Control circuit**

Nominal voltage	480 V AC
Operating voltage range	24 - 230 V UC
Typ. release voltage	5 V UC
Ramp-up time	0.5 ... 30 s
Ramp-down time	0.5 ... 60 s
Torque adjustment	0 ... 85 %
Rated frequency	50 / 60 Hz

**Insulation**

Rated insulation voltage	660 V
Rated impulse withstand voltage	4 kV
Pollution degree	3
Overvoltage category	III

**General data**

Ambient temperature storage	-20 ... 80 °C
Ambient temperature operation	-5 ... 40 °C
Ambient temperature operation derated power	-5 ... 60 °C
Conductor cross section Control / Main Circuit	2.5 mm <sup>2</sup> / 6 mm <sup>2</sup>
Nominal screw torque Control / Main Circuit	0.5 Nm / 1.2 Nm
Module width	fig. 2
Weight	2500 g
Protection degree	IP 20
Housing material	PPE
Mounting	TS 35 or Back Panel Mounting

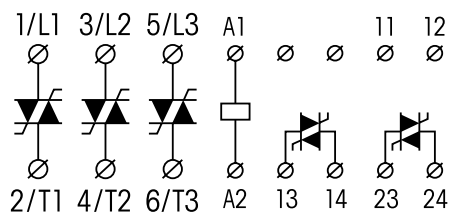
**Product references**

Description	Product reference
Starting Torque Limiter, 3 phase	CCM33H550USi

Other devices on request. Please contact [support@comatreleco.com](mailto:support@comatreleco.com).

**Accessories**

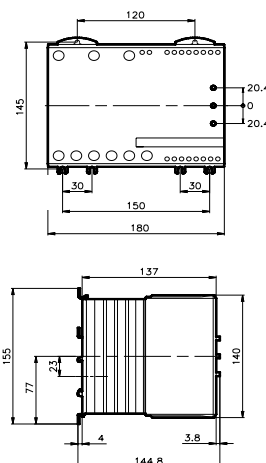
Thermal overload protection	P82-100C
-----------------------------	----------

**fig. 1. Wiring diagram**

11-12: Thermostat

13-14: For control of Start/Stop function

23-24: By end of ramp up time for by-pass contactor

**fig. 2. Dimensions (mm)****Standards and approvals**

Standards IEC/EN 60947, 50022, 60068

Approvals  

**Starting Torque Limiter with dynamic brake | 3 phase | 400 V | 25 A**
**Main circuit**

Number of outputs	3
Controlled phases	2
Output type	Thyristor
Bypass	Externally
Rated voltage	400 V
Output voltage range	400 ... 480 V AC
Reverse voltage	1600 V <sub>rrm</sub>
Peak reverse voltage	1650 V <sub>rrm</sub>
Rated current AC-53a	25 A
Minimum load	1 A
Typ. leakage current	5 mA
Inrush current	200 A
Rated limit load	6300 A <sup>2</sup> t

**Control circuit**

Nominal voltage	480 V AC
Operating voltage range	24 - 230 V UC
Typ. release voltage	5 V UC
Pick-up time	100 ms
Release time	100 ms
Ramp-up time	0.5 ... 10 s
Brake current	0 ... 50 A
Torque adjustment	0 ... 85 %
Rated frequency	50 / 60 Hz

**Insulation**

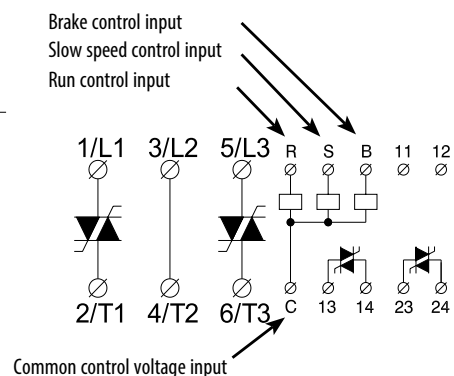
Pollution degree	3
Overvoltage category	III

**General data**

Ambient temperature storage	-20 ... 80 °C
Ambient temperature operation	-5 ... 40 °C
Ambient temperature operation derated power	-5 ... 60 °C
Conductor cross section Control / Main Circuit	2.5 mm <sup>2</sup> / 6 mm <sup>2</sup>
Module width	fig. 2
Weight	1050 g
Protection degree	IP 20
Housing material	PPE
Mounting	TS 35 or Back Panel Mounting

**Product references**

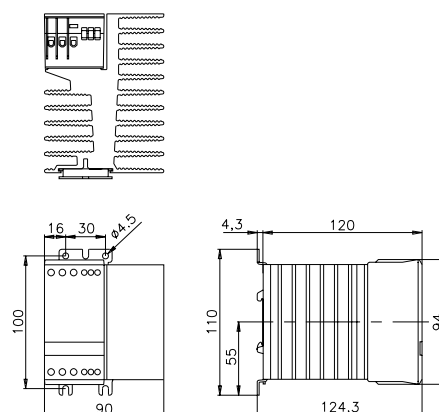
Description	Product reference
Starting Torque Limiter with dynamic brake, 3 phase	CCMB3H425


**fig. 1. Wiring diagram**


11-12: Thermostat

13-14: For control of Start/Stop function

23-24: By end of ramp up time for by-pass contactor

**fig. 2. Dimensions (mm)**


**P82-100C**

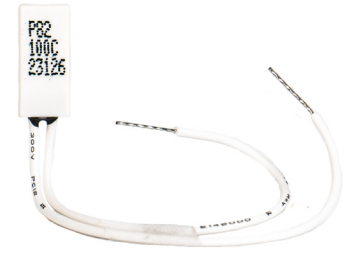
**Thermal overload protection**

**General data**

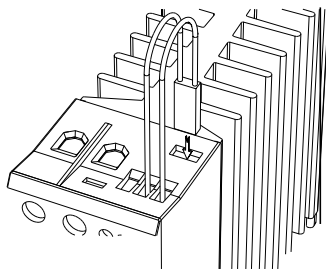
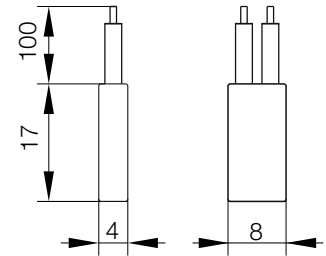
Module width	fig. 1
Weight	3 g
Protection degree	IP 66
Mounting	Slot on contactor
Application	fig. 2

**Product references**

Description	Product reference
Thermal overload protection	P82-100C



**fig. 1. Dimensions (mm)**



Optional thermal overload protection is possible by inserting a thermostat in a slot on the right hand side of the electronic contactor.

**fig. 2. Wiring diagram**

<p><b>Example 1</b></p> <p>Thermostat in series with control circuit of the SSR contactor.</p>	<p><b>Example 2</b></p> <p>Thermostat in series with control circuit from main contactor.</p>
<p><b>Example 3</b></p> <p>Thermostat in series with the control supply of the controller.</p>	<p><b>Example 4</b></p> <p>Thermostat in series with PLC input.</p>

The thermostat is connected in series with the different control circuits. When the controller heatsink temperature exceeds 90° C, the device is switched off. When the controller heatsink has dropped to approx.. 60° C, the control supply is switched On again (depending the chosen control circuit).

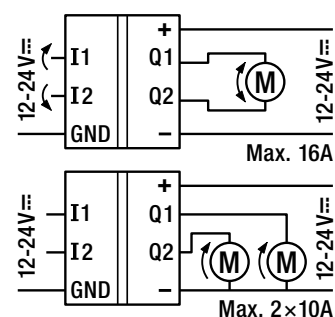
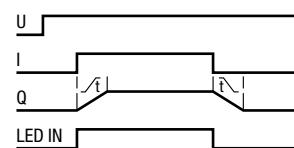
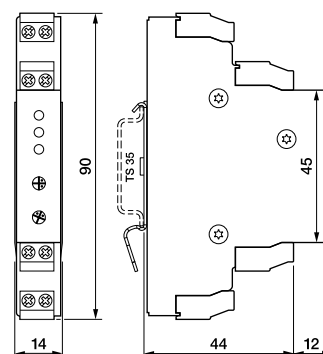
## 6.2 DC Motor Controller

---

Application	Type	Page
<b>CMC Series</b>		
DC Motor Controller   digital inputs   constant speed	CMC1	344
DC Motor Controller   variable speed	CMC14	345
DC Motor Controller   analogue inputs 0 ... 10 V   variable speed	CMC15	346
DC Motor Controller   analogue inputs 4 ... 20 mA   variable speed	CMC16	347
<b>KDM Series</b>		
DC Motor Relay   1 output for motor   1 output for breaking resistor   Faston	KDM3-24	348

**CMC1****DC Motor Controller | digital inputs | constant speed**

<b>Maximum load</b>	<b>16 A / 24 V</b>
<b>Outputs</b>	<b>Drive</b>
Type	Mosfet H bridge
Nominal switching current	16 A
Inrush current	20 A / max. 3 s
Nominal voltage	24 V
Switching power DC-5	384 W
<b>Control Voltage V<sub>n</sub> =</b>	<b>12-24 V</b>
Nominal operating voltage range (DC)	12 – 24 V
Admissible voltage range (DC)	8 – 28 V
Current consumption	DC
12 V	3 mA
24 V	6 mA
<b>Power supply</b>	
Nominal operating voltage (DC)	12 – 24 V
Operating voltage (DC)	8 – 28 V
Max. current consumption without load	10 mA
Max. power consumption	DC
12 V	120 mW
24 V	240 mW
<b>Time response</b>	
Start ramp	0 – 4 s
Breaking ramp	0 – 4 s
<b>Specifications</b>	
Ambient temperature storage/operation	-40 ... 85°C / -25 ... +60°C (no ice)
Connection terminals	Screw terminal 2.5 mm <sup>2</sup>
DC voltage endurance at rated load	> 100 000 h (at 25 °C)
Protection degree	IP 20
Mounting	TS-35 or Back Panel Mounting
Housing material	Aluminium
Weight	80 g

**Product References****DC 12-24****CMC1/DC12-24V****Connection diagram****Function diagram****Dimensions (mm)****Technical approvals, conformities**

IEC/EN 61373



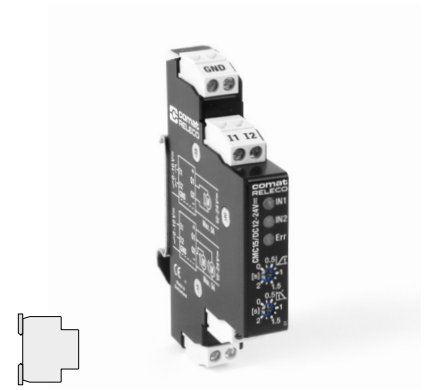
# CMC14

## DC Motor Controller | variable speed

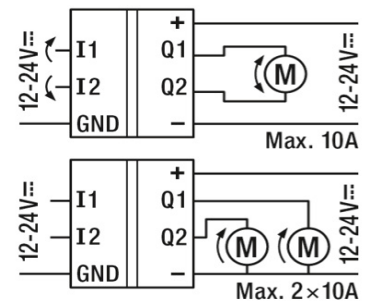
<b>Maximum load</b>	<b>10 A / 24 V</b>
<b>Outputs</b>	<b>Drive</b>
Type	⚡ Mosfet H bridge
Nominal switching current	10 A
Inrush current	20 A / max. 3 s
Nominal voltage	24 V
Switching power DC-5	240 W
<b>Power supply</b>	
Nominal operating voltage (DC)	12 – 24 V
Operating voltage (DC)	8 – 28 V
Max. current consumption without load	10 mA
Max. power consumption	DC
12 V	≤ 150 mW
24 V	≤ 300 mW
<b>Time response</b>	
Start ramp	0 – 4 s
Breaking ramp	0 – 4 s
<b>Specifications</b>	
Ambient temperature storage/operation	-40 ... 85°C / -25 ... +60°C (no ice)
Connection terminals	Screw terminal 2.5 mm <sup>2</sup>
DC voltage endurance at rated load	> 100 000 h (at 25 °C)
Protection degree	IP 20
Mounting	TS-35 or Back Panel Mounting
Housing material	Aluminium
Weight	80 g

**Product References**

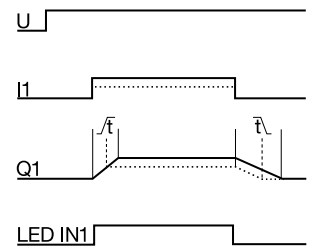
**DC 12-24** **CMC14/DC12-24V**



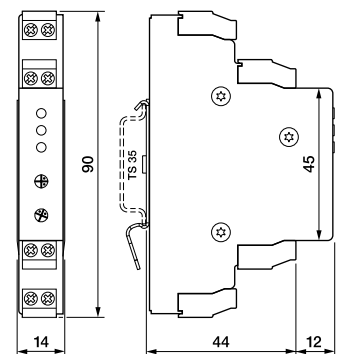
**Connection diagram**



**Function diagram**



**Dimensions (mm)**



**Technical approvals, conformities**



IEC/EN 61373

# CMC15

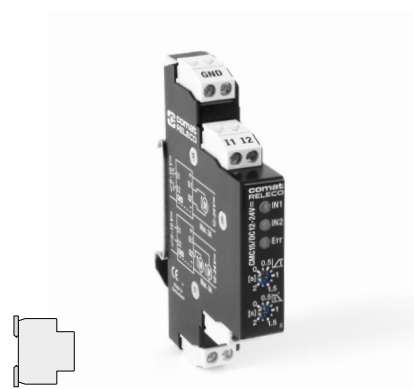
DC Motor Controller | analogue inputs 0 ... 10 V | variable speed



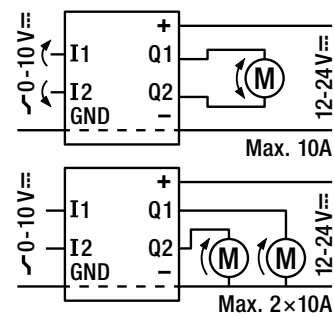
<b>Maximum load</b>	<b>10 A / 24 V</b>
<b>Outputs</b>	
Type	Mosfet H bridge
Nominal switching current	10 A
Inrush current	20 A / max. 3 s
Nominal voltage	24 V
Switching power	240 W
<b>Analogue inputs</b>	
Nominal operating voltage range (DC)	0 – 10 V
Resolution	8 Bit
Input impedance	55 kΩ
<b>Power supply</b>	
Nominal operating voltage (DC)	12 – 24 V
Operating voltage (DC)	8 – 28 V
Max. current consumption without load	10 mA
Max. power consumption	DC
12 V	120 mW
24 V	240 mW
<b>Time response</b>	
Start ramp	0 – 2 s
Breaking ramp	0 – 2 s
<b>Specifications</b>	
Ambient temperature storage/operation	-40 ... 85°C / -25 ... +60°C (no ice)
Connection terminals	Screw terminal 2.5 mm <sup>2</sup>
DC voltage endurance at rated load	> 100 000 h (at 25 °C)
Protection degree	IP 20
Mounting	TS-35 or Back Panel Mounting
Housing material	Aluminium
Weight	80 g

**Product References**

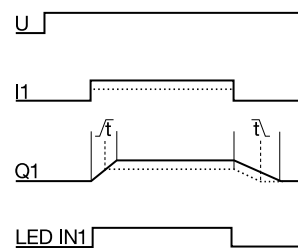
**DC 12-24** CMC15/DC12-24V



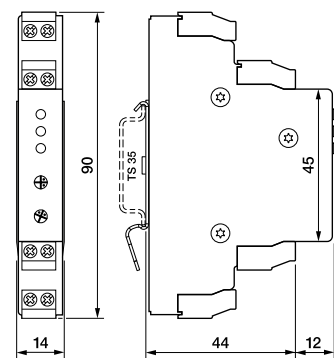
**Connection diagram**



**Function diagram**



**Dimensions (mm)**



**Technical approvals, conformities**



IEC/EN 61373

## CMC16

DC Motor Controller | analogue inputs 4 ... 20 mA | variable speed

**Maximum load** **10 A / 24 V**

### Outputs

Outputs	Drive
Type	Mosfet H bridge
Nominal switching current	10 A
Inrush current	20 A / max. 3 s
Nominal voltage	24 V
Switching power	240 W

### Analogue inputs

Nominal operating voltage range (DC)	4 – 20 mA
Resolution	8 Bit
Input impedance	190 Ω

### Power supply

Nominal operating voltage (DC)	12 – 24 V
Operating voltage (DC)	8 – 28 V
Max. current consumption without load	10 mA
Max. power consumption	DC
12 V	120 mW
24 V	240 mW

### Time response

Start ramp	0 – 2 s
Breaking ramp	0 – 2 s

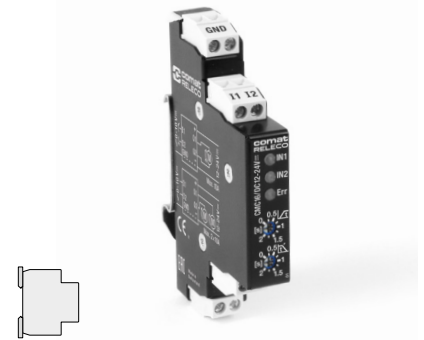
### Specifications

Ambient temperature storage/operation	-40 ... 85°C / -25 ... +60°C (no ice)
Connection terminals	Screw terminal 2.5 mm <sup>2</sup>
DC voltage endurance at rated load	> 100 000 h (at 25 °C)
Protection degree	IP 20
Mounting	TS-35 or Back Panel Mounting
Housing material	Aluminium
Weight	80 g

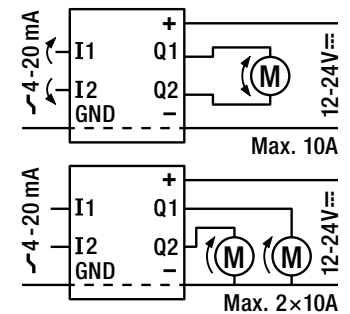
### Product References

DC 12-24

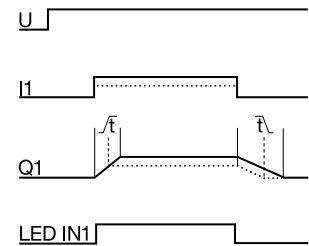
CMC16/DC12-24V



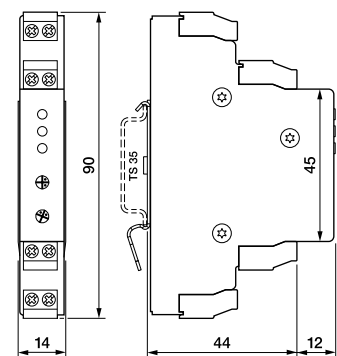
### Connection diagram



### Function diagram



### Dimensions (mm)



### Technical approvals, conformities



IEC/EN 61373

# KDM3-24

DC Motor Relay | 1 output for motor | 1 output for braking resistor | Faston



### Maximum load

**3 A / 32 V**

### Outputs

Type: Power MOS FET  
 Max. switching current  
 Max. continuous current  
 Max. inrush current, 1 sec<sup>2)</sup>  
 Switching voltage range  
 Max. Load  
 Thermal overload protection<sup>2)</sup>  
 Over current limiting<sup>2)</sup>  
 Clamp voltage  
 Max. inductive switch-off energy<sup>2)</sup>  
 ON resistance @ 25 °C  
 Leakage current

### Drive

High side  
 3 A  
 3 A (5 A)<sup>1)</sup>  
 20 A  
 10 ... 32 V  
 100 W  
 self restoring  
 type. 35 A  
 type. 58 V  
 1 Ws single pulse  
 ≤ 50 mΩ  
 ≤ 10 μA

### Brake

N-channel  
 3 A, 10 sec  
 2 A  
 7  
 10 ... 32 V  
 65 W  
 self restoring  
 7 ... 14 A  
 60 ... 70 V  
 0.4 Ws single pulse  
 ≤ 100 mΩ

<sup>1)</sup> Repetitive operation: When the ratio  $t_{pulse} / t_{cycle}$  is a low value then the current can be increased up to 5 A @  $T_A \leq 50$  °C.

<sup>2)</sup> Not for continuous repetitive operation

### Control Voltage $V_N =$

Operating voltage range  
 Release voltage  
 Typical input current @ 12 / 24 V  
 Power consumption @ 12 / 24 V  
 Polarity reversal

### DC 12-24 V

9 ... 28 V  
 ≤ 2 V  
 2 / 6.5 mA  
 25 / 160 mW  
 protected

### Specifications

Ambient temperature storage/operation -40 ... 85°C / -25 ... +60°C (no ice)  
 ON delay 1 ms  
 Release time 1 ms  
 Housing material Lexan  
 Weight 27 g

### Product References

DC 12-24

**KDM3-24/DC12-24V R**

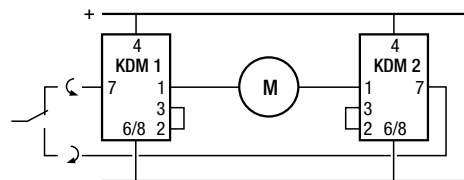
### Accessories

Socket

**S7-C**

### Application example

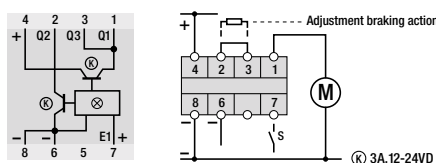
Four quadrant (forward / reversed) motor control



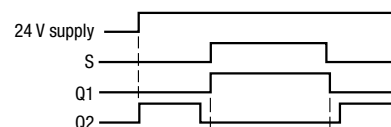
Operating with brake resistors (on 2-3) is not recommended in this application.



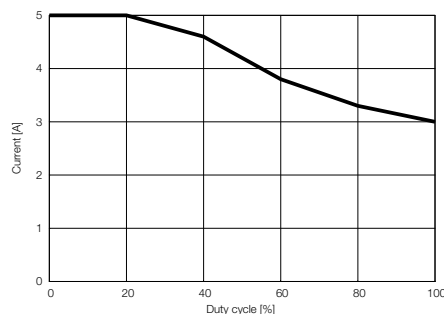
### Connection diagram



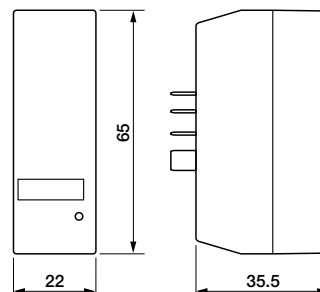
### Function diagram



### Output current vs. duty cycle



### Dimensions (mm)



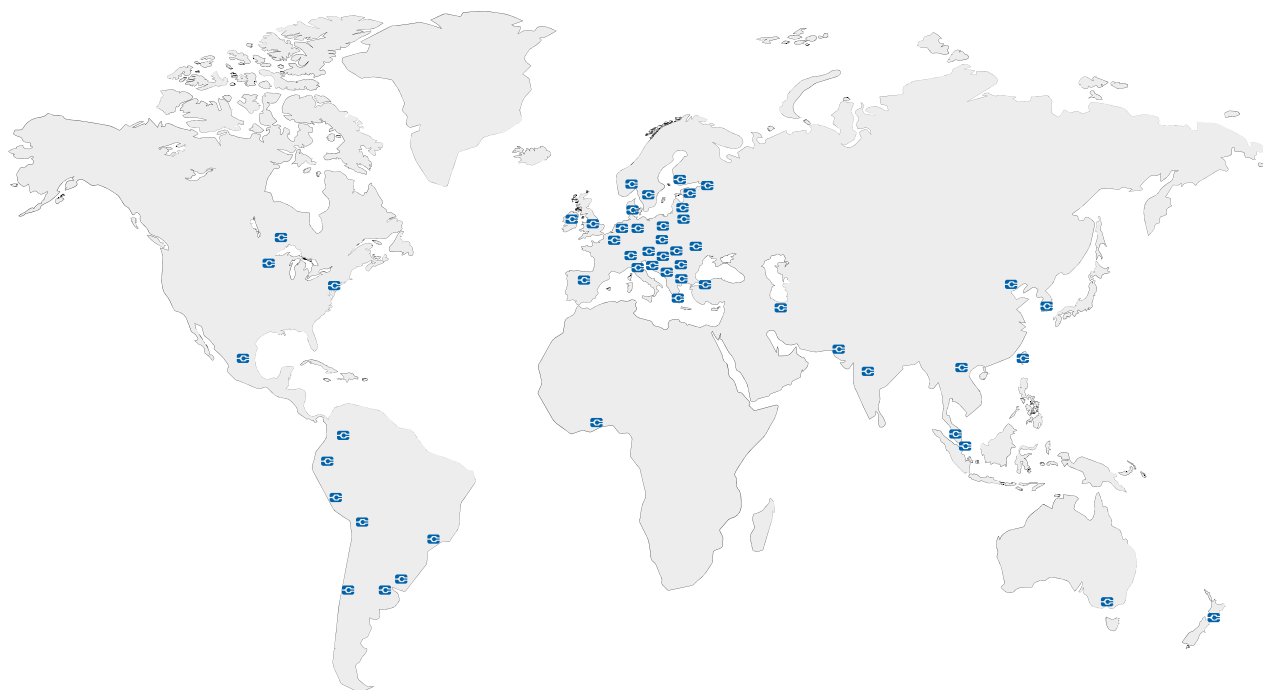
### Technical approvals, conformities





# Worldwide Sales Network

## WORLD OF RELAYS



### ASIA

#### CHINA

ELCO (TIANJIN) ELECTRONICS CO., LTD.  
[www.elco-holding.com](http://www.elco-holding.com)



#### PAKISTAN

GINZA INTERNATIONAL CORPORATION  
[Ginza-int@cyber.net.pk](mailto:Ginza-int@cyber.net.pk)



#### TURKEY

ILERI OTOMASYON SISTEMLERI SAN. LTD. STI.  
[www.ileriotomasyon.com](http://www.ileriotomasyon.com)



#### INDIA

CONCORD AUTOMATION & CONTROLS  
[www.cacindia.net](http://www.cacindia.net)



#### SINGAPORE

FUTRON ELECTRONICS PTE. LTD.  
[www.futronelectronics.com.sg](http://www.futronelectronics.com.sg)



#### VIETNAM

PLC PRODUCTION AND TRADE COMPANY LIMITED  
[plchanoi@gmail.com](mailto:plchanoi@gmail.com)



#### IRAN

DANESH ENERGY SARIR CO.  
[www.desc-co.com](http://www.desc-co.com)



#### TAIWAN

Z-NANOCON & AUTOMATION INT'L CORP  
[www.e-sensors.com.tw](http://www.e-sensors.com.tw)



#### KOREA

MAHANI ELECTRIC CO., LTD.  
[www.mec.co.kr](http://www.mec.co.kr)



#### THAILAND

538 CO., LTD.  
[538LTD@gmail.com](mailto:538LTD@gmail.com)



#### MALAYSIA

ELECTRICAL MARKETING SDN. BHD  
[emsb@tm.net.my](mailto:emsb@tm.net.my)



SRINUTCH COMPONENTS CO., LTD.  
[www.srinutch.com](http://www.srinutch.com)

### AUSTRALIA

#### AUSTRALIA

ARLIN PTY LTD.  
[www.arlin.com.au](http://www.arlin.com.au)



#### NEW ZEALAND

CUTHBERT STEWART LTD.  
[www.cuthbertstewart.co.nz](http://www.cuthbertstewart.co.nz)



## EUROPE

<p><b>AUSTRIA</b> ELTAX ELEKTRO- UND KOMMUNIKATIONSTECHNIK GMBH <a href="http://www.eltax.at">www.eltax.at</a></p> <p>TURCK GmbH <a href="http://www.turck.at">www.turck.at</a></p>		<p><b>GREAT BRITAIN</b> CAMIS ELECTRONICS LTD. <a href="http://www.camiselectronicssuk.com">www.camiselectronicssuk.com</a></p> <p>OEM AUPTOMATIC LTD. <a href="http://www.oem.co.uk">www.oem.co.uk</a></p>		<p><b>REPUBLIC OF MACEDONIA</b> TIPTEH SKOPJE D.O.O. <a href="http://www.tipteh.mk">www.tipteh.mk</a></p>	
<p><b>BELGIUM</b> TURCK MULTIPROX N.V. <a href="http://www.multiprox.be">www.multiprox.be</a></p>		<p><b>GREECE</b> MEGA EL. (VASSILIS GETSOS A.) <a href="http://www.megael.gr">www.megael.gr</a></p>		<p><b>RUSSIA</b> POLIGON LTD. <a href="http://www.poligon.info">www.poligon.info</a></p>	
<p><b>BOSNIA AND HERZEGOVINA</b> TIPTEH D.O.O. <a href="http://www.tipteh.ba">www.tipteh.ba</a></p>		<p><b>HUNGARY</b> OEM AUTOMATIC KFT. <a href="http://www.oemautomatic.hu">www.oemautomatic.hu</a></p>		<p>SEVERCO, LTD. <a href="mailto:elcomp@poligon.info">elcomp@poligon.info</a></p>	
<p><b>BULGARIA</b> SENSOMAT LTD. <a href="http://www.sensomat.info">www.sensomat.info</a></p>		<p><b>IRELAND</b> TCM CONTROLS LTD. <a href="http://www.tcmcontrols.com">www.tcmcontrols.com</a></p>		<p><b>SERBIA</b> TIPTEH D.O.O. BEOGRAD <a href="http://www.tipteh.rs">www.tipteh.rs</a></p>	
<p><b>CROATIA</b> TIPTEH ZAGREB D.O.O. <a href="http://www.tipteh.hr">www.tipteh.hr</a></p> <p>VARGA ELEKTRONIK D.O.O. <a href="http://www.varga-elektronik.hr">www.varga-elektronik.hr</a></p>		<p><b>ITALY</b> S.P.I.I. S.P.A. <a href="http://www.sp.ii.it">www.sp.ii.it</a></p> <p>SOFTING ITALIA SRL. <a href="http://www.softingitalia.it">www.softingitalia.it</a></p>		<p><b>SLOVAKIA</b> MARPEX, S.R.O. <a href="http://www.marpex.sk">www.marpex.sk</a></p> <p>OEM AUTOMATIC, S R.O. <a href="http://www.oem.sk">www.oem.sk</a></p>	
<p><b>CZECH REPUBLIC</b> OEM AUTOMATIC, SPOL. S.R.O. <a href="http://www.oem-automatic.cz">www.oem-automatic.cz</a></p> <p>TURCK S.R.O. <a href="http://www.turck.cz">www.turck.cz</a></p>		<p><b>LITHUANIA</b> HIDROTEKA ENGINEERING SERVICES <a href="http://www.hidroteka.lt">www.hidroteka.lt</a></p>		<p><b>SLOVENIA</b> TIPTEH D.O.O. <a href="http://www.tipteh.si">www.tipteh.si</a></p>	
<p><b>DENMARK</b> OEM AUTOMATIC KITSO A/S <a href="http://www.oemkitso.dk">www.oemkitso.dk</a></p>		<p><b>LATVIA</b> OEM AUTOMATIC UAB <a href="http://www.oem.ee">www.oem.ee</a></p>		<p><b>SPAIN</b> DISAILECO, SL <a href="http://www.disaileco.com">www.disaileco.com</a></p>	
<p><b>ESTONIA</b> OEM EESTI OÜ <a href="http://www.oem.ee">www.oem.ee</a></p>		<p><b>NETHERLANDS</b> VIERPOOL BV. <a href="http://www.vierpool.nl">www.vierpool.nl</a></p>		<p><b>SWEDEN</b> BEVING ELEKTRONIK AB <a href="http://www.beving.se">www.beving.se</a></p> <p>OEM AUTOMATIC AB <a href="http://www.oemautomatic.se">www.oemautomatic.se</a></p>	
<p><b>FINLAND</b> OEM FINLAND OY <a href="http://www.oem.fi">www.oem.fi</a></p>		<p><b>NORWAY</b> OEM AUTOMATIC AS <a href="http://www.oem.no">www.oem.no</a></p>		<p><b>SWITZERLAND</b> COMATRELECO AG <a href="http://www.comatreleco.com">www.comatreleco.com</a></p>	
<p><b>GERMANY</b> COMAT RELECO GMBH <a href="http://www.comatreleco.de">www.comatreleco.de</a></p>		<p><b>POLAND</b> ANIM SPÓŁKA Z OGRANICZONA ODPOWIEDZIALNOSCIA SP.K. <a href="http://www.anim.com.pl">www.anim.com.pl</a></p> <p>ASTAT LOGISTYKA SP. Z O.O. <a href="http://www.astat.com.pl">www.astat.com.pl</a></p> <p>OEM AUTOMATIC SP. Z O.O. <a href="http://www.oemautomatic.com.pl">www.oemautomatic.com.pl</a></p>			

## AFRICA

<p><b>NIGERIA</b> PANEK GLOBAL SERVICES LTD. <a href="http://www.panekglobal.com/">www.panekglobal.com/</a></p>	
---	--

# Worldwide Sales Network

## NORTH & CENTRAL AMERICA

### CANADA

TURCK CANADA INC.  
[www.turck.ca](http://www.turck.ca)



### MEXICO

TURCK MEXICO S. DE R.L.DE C.V.  
[www.turck.com.mx](http://www.turck.com.mx)



### UNITED STATES

ELECTROTECH SALES GROUP LLC  
[www.esgllc-usa.com](http://www.esgllc-usa.com)



TURCK INC.  
[www.turck.us](http://www.turck.us)

## SOUTH AMERICA

### ARGENTINA

WINTERS INSTRUMENTS S.A.  
[www.winters.com.ar](http://www.winters.com.ar)



### CHILE

RHOMBERG LTDA.  
[www.rhomberg.cl](http://www.rhomberg.cl)



### PERU

PROMOTORES ELÉCTRICOS S.A.  
[www.promelsa.com.pe](http://www.promelsa.com.pe)



### BOLIVIA

LEVCorp S.A.  
[www.levcorp.bo](http://www.levcorp.bo)



### COLOMBIA

ACJ HIGH VOLTAGE LTDA.  
[www.acj.com.co](http://www.acj.com.co)



### URUGUAY

ELEKTROSWEDEN S.A.  
[www.elektrosweden.com.uy](http://www.elektrosweden.com.uy)



### BRAZIL

COMAT RELECO DO BRASIL  
[www.comatreleco.com.br](http://www.comatreleco.com.br)



### ECUADOR

IANDCECONTROL, S.A.  
[www.iandcecontrol.com](http://www.iandcecontrol.com)









