



- Loadmonitors - GAMMA series
- Multifunction
- Temperature monitoring of the motor winding
- Reset-key
- Fault latch
- Recognition of disconnected load
- Suitable for VFI (10 to 100Hz)
- Supply voltage selectable via power modules
- 2 change over contacts
- Width 45mm
- Industrial design



Read and understand these instructions before installing, operating or maintaining the equipment.



Danger!

Never carry out work on live parts! Danger of fatal injury! The product must not be used in case of obvious damage. To be installed by an authorized person.

Technical data

1. Functions

True power monitoring in 1- and 3-phase loads with adjustable thresholds (P1 and P2), timing for start-up suppression time and tripping delay separately adjustable, selectable fault latch, temperature monitoring of the motor winding with max. 6 PTC, reset-key and the following functions which are selectable by means of rotary switch:

2MIN	Minimum monitoring
2MIN+I< ON	Minimum monitoring and recognition of disconnected consumers (relay ON if I<)
2MIN+I< Inv.	Minimum monitoring and recognition of disconnected consumers (relay OFF if I< Inv.)
2MAX	Maximum monitoring
2MAX+I< ON	Maximum monitoring and recognition of disconnected consumers (relay ON if I<)
2MAX+I< Inv.	Maximum monitoring and recognition of disconnected consumers (relay OFF if I< Inv.)
WIN	Monitoring the window between MIN and MAX
WIN+I< ON	Monitoring the window between MIN and MAX and recognition of disconnected consumers (relay ON if I<)
WIN+I< Inv.	Monitoring the window between MIN and MAX and recognition of disconnected consumers (relay OFF if I< Inv.)
MIN/MAX	Minimum- and maximum monitoring
MIN/MAX+I< ON	Minimum- and maximum monitoring and recognition of disconnected consumers (relay ON if I<)
MIN/MAX+I< Inv.	Minimum- and maximum monitoring and recognition of disconnected consumers (relay OFF if I< Inv.)

2. Time ranges

	Adjustment range
Start-up suppression time:	1s 100s
Tripping delay:	0.1s 50s

3. Indicators

Green LED U/t ON:	indication of supply voltage
Green LED U/t flashes:	indication of start-up suppression time
Yellow LED I=0 ON/OFF:	indication of disconnected consumers
Red LED Failure ON:	indication of failure of the corresponding threshold P1 or P2
Red LED Failure flashes:	indication of tripping delay of the corresponding threshold P1 or P2
Red LED Temp ON/OFF:	indication of overtemperature
Yellow LED Rel 1 ON/OFF:	indication of relay output Rel 1
Yellow LED Rel 2 ON/OFF:	indication of relay output Rel 2

4. Mechanical design

Self-extinguishing plastic housing, IP rating IP40
 Mounted on DIN-Rail TS 35 according to EN 60715
 Mounting position: any
 Shockproof terminal connection according to VBG 4 (PZ1 required), IP rating IP20
 Tightening torque: max. 1Nm
 Terminal capacity:
 1 x 0.5 to 2.5mm² with/without multicore cable end
 1 x 4mm² without multicore cable end
 2 x 0.5 to 1.5mm² with/without multicore cable end
 2 x 2.5mm² flexible without multicore cable end

5. Input circuit

Supply voltage:
 12 to 500V a.c. terminals A1-A2 (galvanically separated) selectable via power module type TR3 according to specification of power module
 Tolerance:
 Rated frequency:
 Rated consumption:
 Duration of operation:
 Reset time:
 Ripple and noise:
 Drop-out voltage:
 Overvoltage category:
 Rated surge voltage:

3.5VA (3W)
 100%
 500ms
 -
 >30% of the supply voltage
 III (in accordance with IEC 60664-1)
 6kV

6. Output circuit

2 potential free change over contacts
 Rated voltage: 250V a.c.
 Switching capacity: 750VA (3A / 250V a.c.)
 If the distance between the devices is less than 5mm!
 Rated voltage: 1250VA (5A / 250V a.c.)
 If the distance between the devices is greater than 5mm!
 Fusing: 5A fast acting
 Mechanical life: 20 x 10⁶ operations
 Electrical life: 2 x 10⁵ operations at 1000VA resistive load
 Switching capacity: max. 60/min at 100VA resistive load
 max. 6/min at 1000VA resistive load (in accordance with IEC 60947-5-1)
 Withstand voltage across open contacts:
 1000Veff a.c.
 Overvoltage category: III (in accordance with IEC 60664-1)
 Rated surge voltage: 4kV

7. Measuring circuit

Measuring range P_N: reversible between 2kW, 4kW, 8kW and 16kW

Technical data

Wave form:	
AC Sinus:	10 to 400Hz
Sinus weighted PWM:	10 to 100Hz
Measuring input voltage:	terminals L1-L2-L3
1-phase load:	42 to 690V a.c.
3-phase load:	3~ 42 to 690/400V
Overload capacity:	
1-phase load:	796V a.c.
3-phase load:	3~ 796/460V
Input resistance:	1.25MΩ
Measuring input current:	terminals i-k
Measuring range 2kW, 4kW:	0.2 to 8A
Measuring range 8kW, 16kW:	0.4 to 16A (for I>16A distance >5mm)
Overload capacity:	18A permanent
Input resistance:	<10mΩ

I< - recognition:	
Power interruption:	
Measuring range 2kW, 4kW:	200mA
Measuring range 8kW, 16kW:	400mA
Current flow recognition:	
Measuring range 2kW, 4kW:	240mA
Measuring range 8kW, 16kW:	480mA
Switching threshold P:	
Switching threshold P1:	10% to 120% of P _N
Switching threshold P2:	5% to 110% of P _N
Hysteresis:	1% of maximum value of the measuring range

Temperature monitoring:	
Terminals:	T1-T2
Initial resistance:	<1.5kW
Response value (Relais in on-position):	≥3.6kW
Release value (Relais in off-position):	≤1.8kW
Disconnection (short circuit thermistor):	no
Measuring voltage T1-T2:	≤7.5V at R ≤4.0kW (in accordance with EN 60947-8) III (in accordance with IEC 60664-1)
Overvoltage category:	III
Rated surge voltage:	6kV

8. Control contact Y (equipotential with measuring circuit)	
Function:	latch (terminal Y1-Y2 bridged)
Loadable:	no
Control pulse length:	-
Reset:	normally closed contact in the input circuit

9. Accuracy	
Base accuracy:	±2% (of maximum scale value)
Frequency response:	±0.025% / Hz
Adjustment accuracy:	≤5% (of maximum scale value)
Repetition accuracy:	±2%
Voltage influence:	-
Temperature influence:	≤0.02% / °C

10. Ambient conditions	
Ambient temperature:	-25 to +55°C (in accordance with IEC 60068-1) -25 to +40°C (in accordance with UL 508)
Storage temperature:	-25 to +70°C
Transport temperature:	-25 to +70°C
Relative humidity:	15% to 85% (in accordance with IEC 60721-3-3 class 3K3)
Pollution degree:	2 (in accordance with EN 60255-27)
Vibration resistance:	class 1 (in accordance with EN 60255-22-1)
Shock resistance:	class 1 (in accordance with EN 60255-22-2)

Functions

When the supply voltage U is applied (green LED U/t illuminated) the output relays Rel 1 and Rel 2 switches into on-position (yellow LED Rel 1 and Rel 2 illuminated) and the set interval of the start-up suppression time (Start) begins (green LED U/t flashes). Changes of the measured true power during this period don't affect the state of the output relays Rel 1 and Rel 2. After the interval has expired the green LED U/t illuminates steadily.

Minimum monitoring (2MIN)

The adjusted threshold for P1 must be greater than the adjusted threshold for P2. When the measured true power falls below the value adjusted at the P1-regulator, the set interval of the tripping delay (Delay) begins (red LED Failure of the corresponding threshold P1 flashes). After the interval has expired (red LED Failure of the corresponding threshold P1 illuminated), the output relay Rel 1 switches into off-position (yellow LED Rel 1 not illuminated). When the measured true power exceeds the value adjusted at the P2-regulator, the set interval of the tripping delay (Delay) begins (red LED Failure of the corresponding threshold P2 flashes). After the interval has expired (red LED Failure of the corresponding threshold P2 illuminated), the output relay Rel 2 switches into off-position (yellow LED Rel 2 not illuminated). As soon as the measured true power exceeds the adjusted value at the corresponding regulator P1 or P2 (red LED Failure of the corresponding threshold P1 or P2 not illuminated), the output relay Rel 1 or Rel 2 switches into on-position again (yellow LED Rel 1 or Rel 2 illuminated).

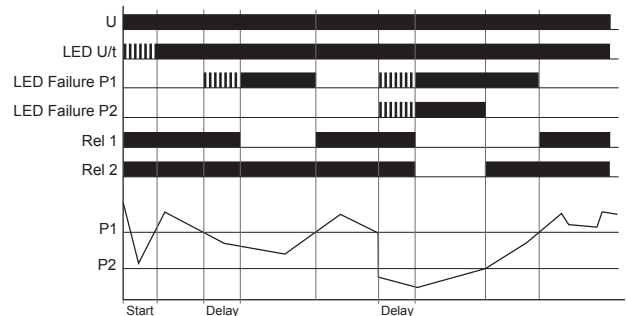

Maximum monitoring (2MAX)

The adjusted threshold for P1 must be greater than the adjusted threshold for P2. When the measured true power exceeds the value adjusted at the P2-regulator, the set interval of the tripping delay (Delay) begins (red LED Failure of the corresponding threshold P2 flashes). After the interval has expired (red LED Failure of the corresponding threshold P2 illuminated), the output relay Rel 2 switches into off-position (yellow LED Rel 2 not illuminated). When the measured true power exceeds the value adjusted at the P1-regulator, the set interval of the tripping delay (Delay) begins (red LED Failure of the corresponding threshold P1 flashes). After the interval has expired (red LED Failure of the corresponding threshold P1 illuminated), the output relay Rel 1 switches into off-position (yellow LED Rel 1 not illuminated). As soon as the measured true power falls below the adjusted value at the corresponding regulator P1 or P2 (red LED Failure of the corresponding threshold P1 or P2 not illuminated), the output relay Rel 1 or Rel 2 switches into on-position again (yellow LED Rel 1 or Rel 2 illuminated).

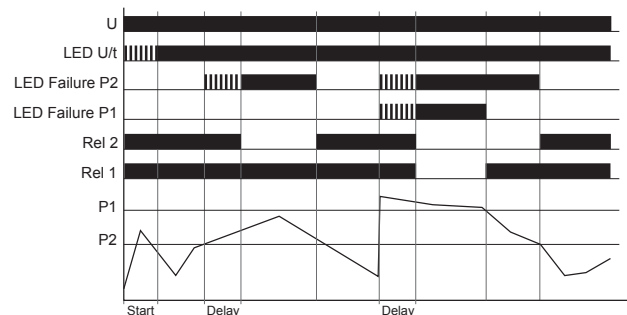

Functions

Window function (WIN)

The adjusted threshold for P1 must be greater than the adjusted threshold for P2. When the measured true power falls below the value adjusted at the P2-regulator, the set interval of the tripping delay (Delay) begins (red LED Failure of the corresponding threshold P2 flashes). After the interval has expired (red LED Failure of the corresponding threshold P2 illuminated), the output relays Rel 1 and Rel 2 switches into off-position (yellow LED Rel 1 and Rel 2 not illuminated). The output relays Rel 1 and Rel 2 switches into on-position again (yellow LED Rel 1 and Rel 2 illuminated), as soon as the measured true power exceeds the adjusted value at the P2-regulator (red LED Failure of the corresponding threshold P2 not illuminated). When the measured true power exceeds the value adjusted at the P1-regulator, the set interval of the tripping delay (Delay) begins (red LED Failure of the corresponding threshold P1 flashes). After the interval has expired (red LED Failure of the corresponding threshold P1 illuminated), the output relays Rel 1 and Rel 2 switches into off-position (yellow LED Rel 1 and Rel 2 not illuminated). As soon as the measured true power falls below the value adjusted at the P1-regulator (red LED Failure of the corresponding threshold P1 not illuminated) the output relays Rel 1 and Rel 2 switches into on-position again (yellow LED Rel 1 and Rel 2 illuminated).

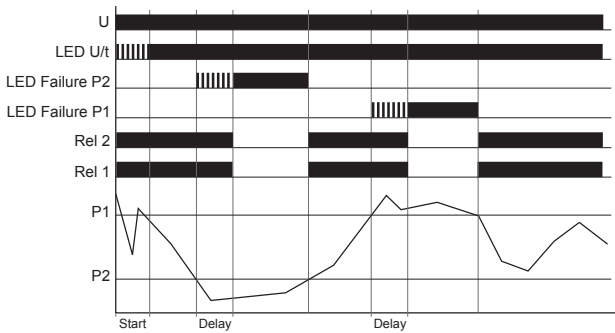

Minimum- and maximum monitoring (MIN/MAX)

The adjusted threshold for P1 must be greater than the adjusted threshold for P2. When the measured true power falls below the value adjusted at the P2-regulator, the set interval of the tripping delay (Delay) begins (red LED Failure of the corresponding threshold P2 flashes). After the interval has expired (red LED Failure of the corresponding threshold P2 illuminated), the output relay Rel 2 switches into off-position (yellow LED Rel 2 not illuminated). The output relay Rel 2 switches into on-position again (yellow LED Rel 2 illuminated), as soon as the measured true power exceeds the adjusted value at the P2-regulator (red LED Failure of the corresponding threshold P2 not illuminated). When the measured true power exceeds the value adjusted at the P1-regulator, the set interval of the tripping delay (Delay) begins (red LED Failure of the corresponding threshold P1 flashes). After the interval has expired (red LED Failure of the corresponding threshold P1 illuminated), the output relay Rel 1 switches into off-position (yellow LED Rel 1 not illuminated). As soon as the measured true power falls below the value adjusted at the P1-regulator (red LED Failure of the corresponding threshold P1 not illuminated) the output relay Rel 1 switches into on-position again (yellow LED Rel 1 illuminated).

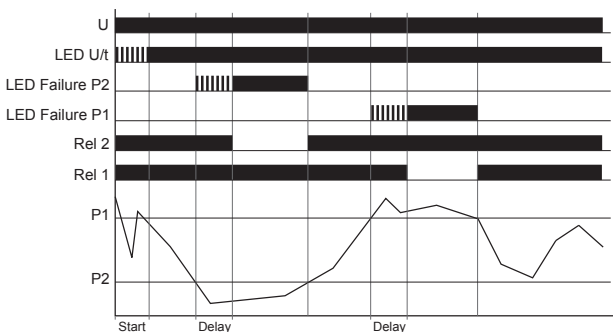

Fault latch

The fault latch can be activated via bridge between the terminals Y1 and Y2. If the fault latch is activated and a failure has occurred (red LED of the corresponding threshold or red LED Temp illuminated), the failure can only be reset by interrupting the supply voltage or pressing the reset-key. After resetting the failure and re-applying of the supply voltage, the output relays Rel 1 and Rel 2 switches into on-position again and the measuring cycle begins with the set interval of the start-up suppression time (Start).

Note:

The fault latch remains active inspite of a I=0 recognition!

Example: Window function (WIN) - Resetting the fault latch by interrupting the supply voltage

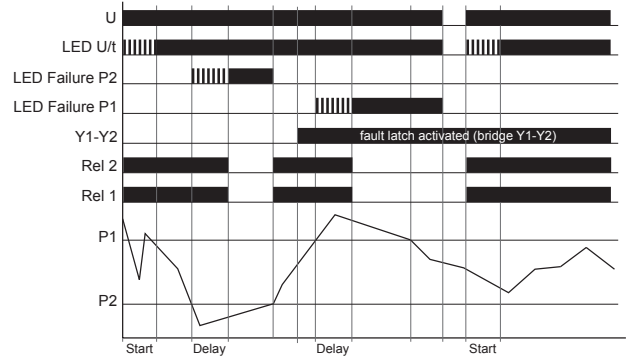

Example: Window function (WIN) - Resetting the fault latch by pressing the reset-key

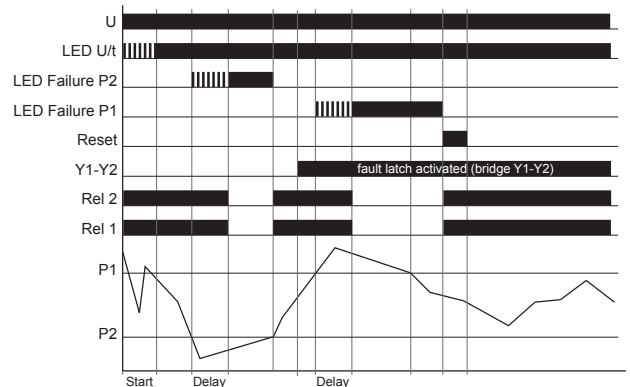

Functions

Recognition of disconnected consumers

The following applies for functions, where the I=0 recognition is activated:

When the current flow between i and k is interrupted (yellow LED I=0 illuminated) and the minimum-, window- or minimum- and maximum function is activated (2MIN+I=0, WIN+I=0, MIN/MAX+I=0), the output relays Rel 1 and Rel 2 remains into on-position (yellow LED Rel 1 and LED Rel 2 illuminated).

When the maximum function is activated (2MAX+I=0), the output relays Rel 1 and Rel 2 switches into off-position (yellow LED Rel 1 and LED Rel 2 not illuminated).

When the current flow restores, the measuring cycle is restarted with the set interval of the start-up suppression time (Start) (green LED U/t flashes).

The following applies for functions, where the inverted I=0 recognition is activated:

When the current flow between i and k is interrupted (yellow LED I=0 illuminated), the output relays behaves inverse to the above mentioned function.

If the minimum-, window- or minimum- and maximum function (2MIN+I=0 Inv., WIN+I=0 Inv., MIN/MAX+I=0 Inv.) is activated, the output relays Rel 1 and Rel 2 switches into off-position (yellow LED Rel 1 and LED Rel 2 not illuminated).

When the maximum function is activated (2MAX+I=0 Inv.), the output relays Rel 1 and Rel 2 remains in on-position (yellow LED Rel 1 and LED Rel 2 illuminated).

When the current flow restores, the measuring cycle is restarted with the set interval of the start-up suppression time (Start) (green LED U/t flashes).

I=0 with minimum monitoring (2MIN+I=0)

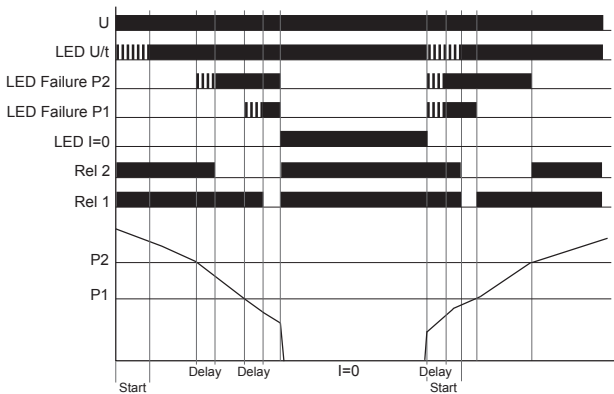

I=0 Inv. with minimum monitoring (2MIN+I=0 Inv.)

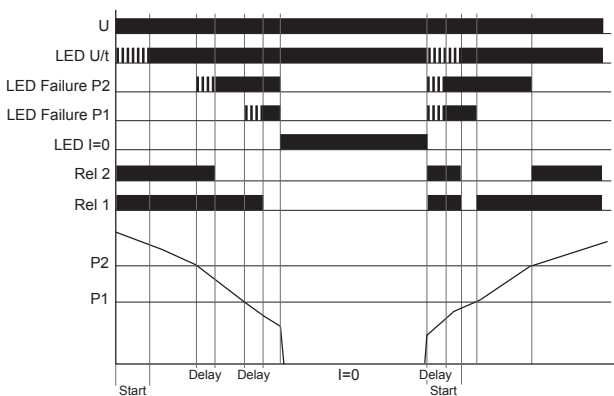

I=0 with maximum monitoring (2MAX+I=0)

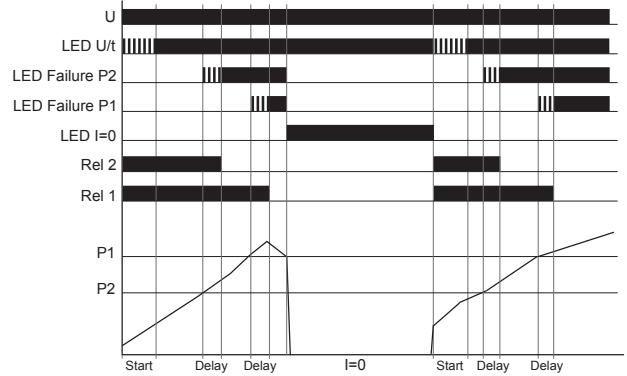

I=0 Inv. with maximum monitoring (2MAX+I=0 Inv.)

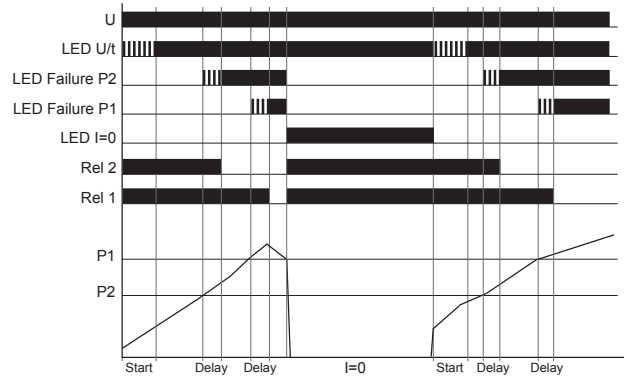

Temperature monitoring of the motor winding

If the supply voltage U is applied (green LED U/t illuminated) and the cumulative resistance of the PTC-circuit is less than 3.6kΩ (standard temperature of the motor), the output relay Rel 2 switches into on-position if no other failure is applied! When the cumulative resistance of the PTC-circuit exceeds 3.6kΩ (at least one of the PTCs has reached the cut-off temperature), the output relay Rel 2 switches into off-position (yellow LED Rel 2 not illuminated) and a failure will be indicated (red LED Temp illuminated). The output relay Rel 2 switches into on-position again (yellow LED Rel 2 illuminated) respectively the failure will be cancelled (red LED Temp not illuminated), if the cumulative resistance drops below 1.8kΩ by cooling down of the PTC. If the fault latch is activated, a press of the reset-key is required to cancel the temperature failure.

Temperature monitoring without fault latch

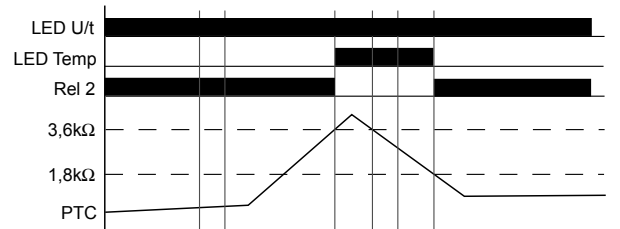

Temperature monitoring with fault latch

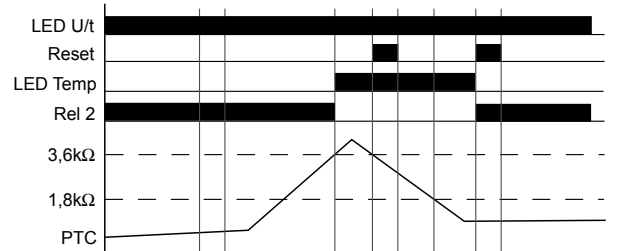

Note: If the output relay Rel 2 should switch into on-position again, no other failure should be applied!

Connections

Connected 3~ 400/690V with power module 24V a.c. without fault latch $I_N < 16A$

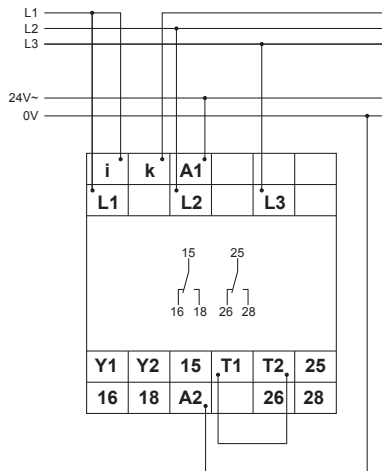

Connected 3~ 400/690V with power module 400V a.c. with fault latch and current transformer $I_N > 16A$

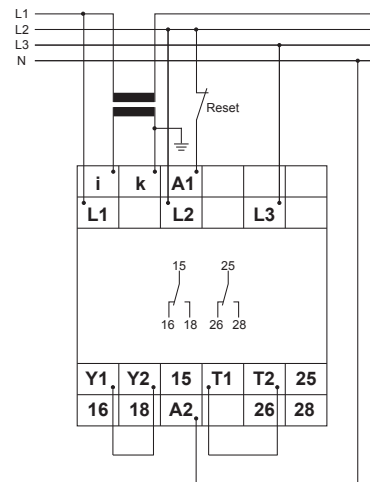

Connected 3~ 500V with power module 500V a.c. with fault latch $I_N < 16A$

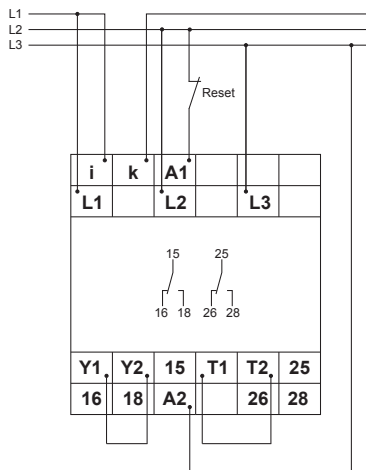

Note:

Before working on current transformer circuits, these shall be short-circuited.

Dimensions

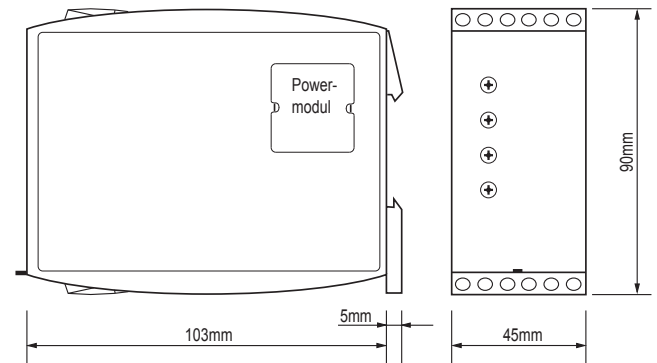

Connected 3~ 230/400V with power module 230V a.c. with fault latch and temperature monitoring sensor $I_N < 16A$

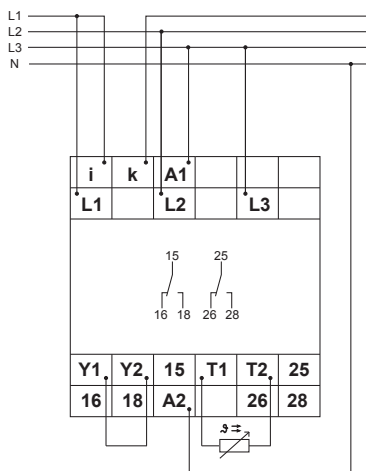

TELE Haase Steuergeräte Ges.m.b.H.
Vorarlberger Allee 38
A-1230 Wien

RELEASE 2010/12

Subject to alterations and errors