

ENYA series
 Multifunction
 7 functions
 7 time ranges
 Wide input voltage range
 1 change over and 1 normally open contact
 Width 17.5 mm
 Installation design



Technical data

1. Functions

The function has to be set before connecting the relay to the supply voltage.

E	ON delay
R	OFF delay
Ws	Single shot leading edge with control input
Wa	Single shot trailing edge with control input
Es	ON delay with control input
Wu	Single shot leading edge voltage controlled
Bp	Flasher pause first

2. Time ranges

Time range	Adjustment range	
1s	50ms	1s
10s	500ms	10s
1min	3s	1min
10min	30s	10min
1h	3min	1h
10h	30min	10h
100h	5h	100h

3. Indicators

Green LED U/t ON:	indication of supply voltage
Green LED U/t flashes:	indication of time period
Yellow LED R ON/OFF:	indication of relay output

4. Mechanical design

Self-extinguishing plastic housing, IP rating IP40
 Mounted on DIN-rail TS 35 according to EN 60715
 Mounting position: any
 Shockproof terminal connection according to VBG 4 (PZ1 required),
 IP rating IP20
 Tightening torque: max. 1Nm
 Terminal capacity:
 1 x 0.5 to 2.5mm² with/without multicore cable end
 1 x 4mm² without multicore cable end
 2 x 0.5 to 1.5mm² with/without multicore cable end
 2 x 2.5mm² flexible without multicore cable end

5. Input circuit

Supply voltage:	24 to 240V a.c./d.c terminals A1(+)-A2
Tolerance:	-15% to +10%
Rated consumption:	6VA (1.5W)
Rated frequency:	a.c. 48 to 63Hz
Duty cycle:	100%
Reset time:	100ms
Residual ripple for d.c.:	10%
Drop-out voltage:	>30% of minimum rated supply voltage
Oversvoltage category:	III (in accordance with IEC 60664-1)
Rated surge voltage:	4kV

6. Output circuit

1 potential free change over and 1 potential free normally open contact	
Rated voltage:	250V a.c.
Switching capacity:	2000VA (8A / 250V a.c.)
Fusing:	8A fast acting
Mechanical life:	20 x 10 ⁶ operations
Electrical life:	2 x 10 ⁵ operations at 1000VA resistive load
Switching frequency:	max. 6/min at 1000VA resistive load (in accordance with IEC 60947-5-1)
Oversvoltage category:	III (in accordance with IEC 60664-1)
Rated surge voltage:	4kV

7. Control input

Input not potential free:	terminals A1-B1
Loadable:	yes
Max. line length:	10m
Trigger level (sensitivity):	automatic adaption to supply voltage
Min. control pulse length:	d.c. 50ms / a.c. 100ms

8. Accuracy

Base accuracy:	±1% of maximum scale value
Adjustment accuracy:	<5% of maximum scale value
Repetition accuracy:	<0.5% or ±5ms
Voltage influence:	-
Temperature influence:	≤0.01% / °C

9. Ambient conditions

Ambient temperature:	-25 to +55°C
Storage temperature:	-25 to +70°C
Transport temperature:	-25 to +70°C
Relative humidity:	15% to 85% (in accordance with IEC 60721-3-3 class 3K3)
Pollution degree:	2 (in accordance with IEC 60664-1)

10. Weight

Single packing:	72g
-----------------	-----

Functions

ON delay (E)

When the supply voltage U is applied, the set interval t begins (green LED U/t flashes). After the interval t has expired (green LED U/t illuminated) the output relay R switches into on-position (yellow LED illuminated). This status remains until the supply voltage is interrupted. If the supply voltage is interrupted before the expiry of the interval t , the interval already expired is erased and is restarted when the supply voltage is next applied.



OFF delay (R)

The supply voltage U must be constantly applied to the device (green LED U/t illuminated). When the control contact S is closed, the output relay R switches into on-position (yellow LED illuminated). If the control contact is opened, the set interval t begins (green LED flashes). After the interval t has expired (green LED U/t illuminated) the output relay switches into off-position (yellow LED not illuminated). If the control contact is closed again before the interval t has expired, the interval already expired is erased and is restarted.

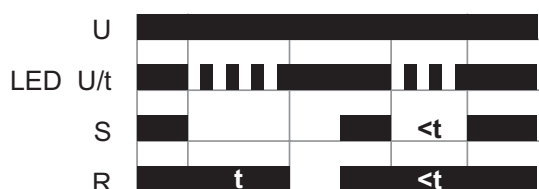

Single shot leading edge with control input (Ws)

The supply voltage U must be constantly applied to the device (green LED U/t illuminated). When the control contact S is closed, the output relay R switches into on-position (yellow LED illuminated) and the set interval t begins (green LED U/t flashes). After the interval t has expired (green LED U/t illuminated) the output relay switches into off-position (yellow LED not illuminated). During the interval, the control contact can be operated any number of times. A further cycle can only be started when the cycle run has been completed.

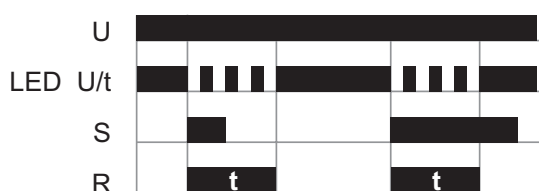

Single shot trailing edge with control input (Wa)

The supply voltage U must be constantly applied to the device (green LED U/t illuminated). Closing the control contact S has no influence on the condition of the output R . When the control contact is opened, the output relay switches into on-position (yellow LED illuminated) and the set interval t begins (green LED U/t flashes). After the interval t has expired (green LED U/t illuminated), the output relay switches into off-position (yellow LED not illuminated). During the interval, the control contact can be operated any number of times. A further cycle can only be started when the cycle run has been completed.

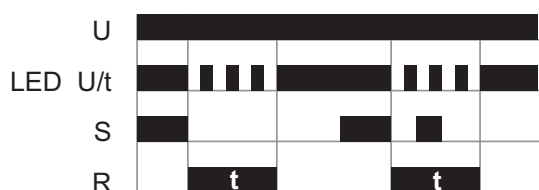

ON delay with control input (Es)

The supply voltage U must be constantly applied to the device (green LED U/t illuminated). When the control contact S is closed, the set interval t begins (green LED U/t flashes). After the interval t has expired (green LED U/t illuminated) the output relay R switches into on-position (yellow LED illuminated). This status remains until the control contact is opened again. If the control contact is opened before the interval t has expired, the interval already expired is erased and is restarted with the next cycle.

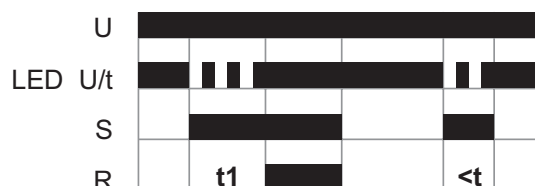

Single shot leading edge voltage controlled (Wu)

When the supply voltage U is applied, the output relay R switches into on-position (yellow LED illuminated) and the set interval t begins (green LED U/t flashes). After the interval t has expired (green LED U/t illuminated) the output relay switches into off-position (yellow LED not illuminated). This status remains until the supply voltage is interrupted. If the supply voltage is interrupted before the interval t has expired, the output relay switches into off-position. The interval already is erased and is restarted when the supply voltage is next applied.



Flasher pause first (Bp)

When the supply voltage U is applied, the set interval t begins (green LED U/t flashes). After the interval t has expired, the output relay R switches into on-position (yellow LED illuminated) and the set interval t begins again. After the interval t has expired, the output relay switches into off-position (yellow LED not illuminated). The output relay is triggered at a ratio of 1:1 until the supply voltage is interrupted.

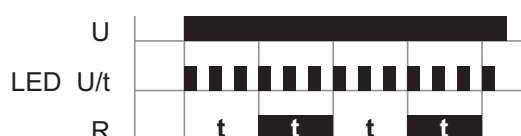

Connections

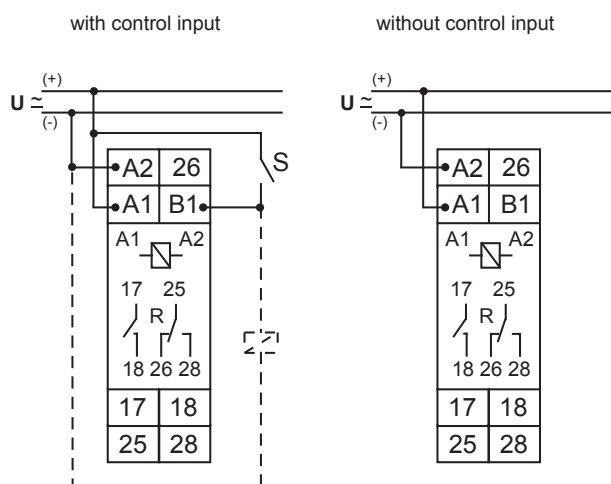

Dimensions

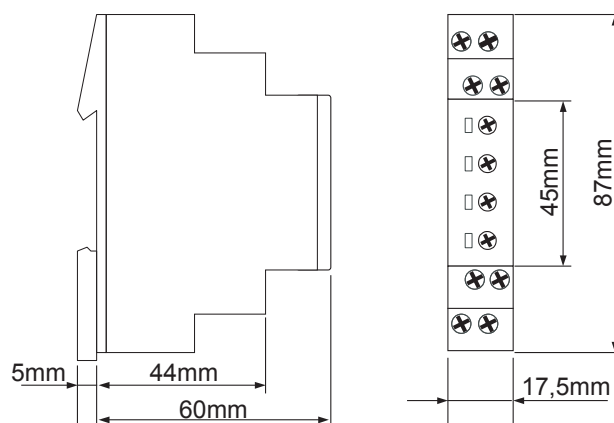

Ordering information

Type	Functions	Supply voltage	Art. No. (PQ 1)	Art. No. (PQ 10)
E1ZM20 24-240V AC/DC	E, R, Ws, Wa, Es, Wu, Bp	24-240V a.c./d.c	110210	-