













	Contents	Page
	Main Switches-Emergency-Stop for Panel Mounting Main Switches-Emergency-Stop for Single Hole Mounting	4, 5 5
	Add-on modules	6, 7
	Main Switches-Emergency-Stop for Base Mounting with Door Clutch	8, 9
	Main Switches-Emergency-Stop for Distribution Boards	10
	Maintenance and Safety Switches, in Plastic Enclosure	11
	Main Switches for Panel Mounting	12
	Main Switches for Base Mounting with Door Clutch	13, 14
	Switch Disconnectors for Panel Mounting	15
	Switch Disconnectors in Plastic Enclosure	16
	Switch Disconnectors for Distribution Boards	16
	Technical Datas	17
	Dimensions	18 - 20

Type	Ratings			Protection degree from front in mounted position				Main Switch Emergency Stop		
	Therm. I <sub>th</sub> open A	AC21 A	at U <sub>e</sub> V	Motor AC3 3~400V kW	AC23 3~400V A	AC23 3~400V kW	Plate Switch disconnect or mm	Panel mounting IP66	Single hole mount. Ø22,5mm IP66	Base mounting with door coupling adjust. installation depth IP66
LTS20	20	20	690	5,5	16	7,5	48□	LTS20 EHN1 .. LTS20 EHN4 ..	LTS20 ZHN1 ..	LTS20 VZVHN4 .. LTS20 VHN4 ..
LTS25	25	25	690	7,5	20	10	48□	LTS25 EHN1 .. LTS25 EHN4 ..	LTS25 ZHN1 ..	LTS25 VZVHN4 .. LTS25 VHN4 ..
LTS32	32	32	690	11	25	12,5	48□	LTS32 EHN1 .. LTS32 EHN4 ..	LTS32 ZHN1 ..	LTS32 VZVHN4 .. LTS32 VHN4 ..
LTS40	40	40	690	15	32	16	48□	LTS40 EHN1 .. LTS40 EHN4 ..	LTS40 ZHN1 ..	LTS40 VZVHN4 .. LTS40 VHN4 ..
LTS63	63	63	690	18,5	45	22	48□	LTS63 EHN1 .. LTS63 EHN4 ..	-	LTS63 VZVHN4 .. LTS63 VHN4 ..
LTS80	80	80	690	18,5	45	22	48□	LTS80 EHN1 .. LTS80 EHN4 ..	-	LTS80 VZVHN4 .. LTS80 VHN4 ..
LTS85	85	85	690	22	60	30	64□	LTS85 EHN4 ..	-	LTS85 VZVHN4 .. LTS85 VHN4 ..
LTS100	100	100	690	30	72	37	64□	LTS100 EHN4 ..	-	LTS100 VZVHN4 .. LTS100 VHN4 ..
LTS125	125	125	690	37	85	45	64□	LTS125 EHN4 ..	-	LTS125 VZVHN4 .. LTS125 VHN4 ..
LT160	160	160	690	45	110	55	88□	LT160 EHN34 ..	-	LT160 VHN34 ..



### Switch disconnecter LT.. 20 - 160A

Switch disconnectors are to be used as an ON-OFF-switch where a high breaking capacity with high contact pressure and in fact better short circuit behavior is necessary. These applications are:

**Main switches** according to IEC/EN 60204 respectively VDE0113 with interlocking device, terminal protection and restrictive contacts.

**Switch disconnectors** according to IEC/EN 60947-3 and VDE 0660 part 107 with break distance for 690V.

**Motor switches** 3-pole or 4-pole; according to IEC/EN 60947-3 respectively VDE 0660 part 107, motor switches series LT are dimensioned for switching high rated current AC3 and AC23A.

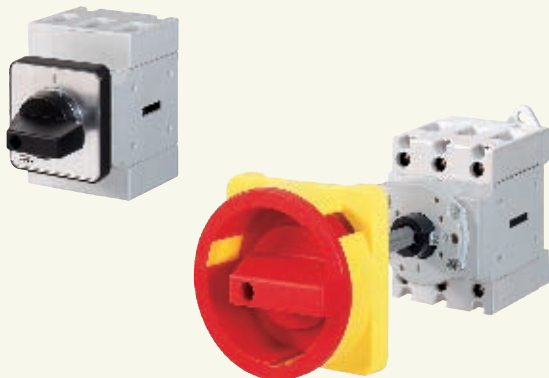

### Main switches and Main switches with Emergency-Stop function

According to standards IEC/EN60204 or VDE0113, all electrical equipment of industrial machines must be equipped with a main switch. This must permit disconnection of all the electrical equipment during cleaning, maintenance and repair work, and other extended periods when it is stationary.

In case of two or more main switches, an interlock system must be used. It is recommended to use a multiple-pole main switch (cam switch).

**Main switches** have to correspond to:

- Switch disconnecter according to IEC/EN 60947-3 and VDE 0660 part 107 for utilization category AC23-B or DC-23B.
- Disconnectors are selected according to thermal rated current. They must possess a contact that ensures load switching via the contactors (see switching program A3-10). This contact must have a sufficient AC15 switching capacity.
- The interruption capacity of the switch must equal or exceed the locked rotor current of the largest motor plus the total current of all other electrical equipment in the circuit.

Requirements:

Interruption of the electrical equipment, with only on and off positions clearly marked with O and I.

It must be lockable in the off setting.

The line terminals of the main switch must be protected according to utilization category IP2X.

Colour of handle black or grey.









**Main switches with Emergency-Off function** are additional supplied with red handles and contrasting yellow escutcheon plates.

Main Switch Emergency Stop			Main Switch		Switch Disconnectors	
Base mounting w. door coupling depth not adjustable IP66	Modular switch IP40	Plastic enclosed IP65	Panel mounting IP66	Base mounting with door coupling IP66	Panel mounting IP66	Modular switch IP40
						
LTS20 VZHN1 .. LTS20 VZHN4 ..	LTS20 SMAHN1 ..	LTS20 PFHN4 ..	LTS20 EH1 .. LTS20 EH4 ..	LTS20 VZVH4 .. LTS20 VH4 ..	LTS20 E ..	LTS20 SMA ..
LTS25 VZHN1 .. LTS25 VZHN4 ..	LTS25 SMAHN1 ..	LTS25 PFHN4 ..	LTS25 EH1 .. LTS25 EH4 ..	LTS25 VZVH4 .. LTS25 VH4 ..	LTS25 E ..	LTS25 SMA ..
LTS32 VZHN1 .. LTS32 VZHN4 ..	LTS32 SMAHN1 ..	LTS32 PFHN4 ..	LTS32 EH1 .. LTS32 EH4 ..	LTS32 VZVH4 .. LTS32 VH4 ..	LTS32 E ..	LTS32 SMA ..
LTS40 VZHN1 .. LTS40 VZHN4 ..	LTS40 SMAHN1 ..	LTS40 PFHN4 ..	LTS40 EH1 .. LTS40 EH4 ..	LTS40 VZVH4 .. LTS40 VH4 ..	LTS40 E ..	LTS40 SMA ..
LTS63 VZHN1 .. LTS63 VZHN4 ..	LTS63 SMAHN1 ..	LTS63 PFHN4 ..	LTS63 EH1 .. LTS63 EH4 ..	LTS63 VZVH4 .. LTS63 VH4 ..	LTS63 E ..	LTS63 SMA ..
LTS80 VZHN1 .. LTS80 VZHN4 ..	LTS80 SMAHN1 ..	LTS80 PFHN4 ..	LTS80 EH1 .. LTS80 EH4 ..	LTS80 VZVH4 .. LTS80 VH4 ..	LTS80 E ..	LTS80 SMA ..
LTS85 VZHN4 ..	LTS85 SMAHN1 ..	LTS85 PFHN4 ..	LTS85 EH4 ..	LTS85 VZVH4 .. LTS85 VH4 ..	LTS85 E ..	LTS85 SMA ..
LTS100 VZHN4 ..	LTS100 SMAHN1 ..	LTS100 PFHN4 ..	LTS100 EH4 ..	LTS100 VZVH4 .. LTS100 VH4 ..	LTS100 E ..	LTS100 SMA ..
LTS125 VZHN4 ..	LTS125 SMAHN1 ..	LTS125 PFHN4 ..	LTS125 EH4 ..	LTS125 VZVH4 .. LTS125 VH4 ..	LTS125 E ..	LTS125 SMA ..
-	-	LT160 PFHN34 ..	LT160 EH34 ..	LT160 VH34 ..	LT160 E ..	-

### Switch program

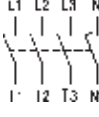
On-Off Switch 3-pole	● ● ● ● ● A3	
On-Off Switch 4-pole	● ● ● ● ● A4	
On-Off Switch 6-pole	● ● ● ● ● A6	
On-Off Switch 8-pole	● ● ● ● ● A8	
Changeover Switches 3-pole	● ● ● ● ● U3	
Changeover Switches 4-pole	● ● ● ● ● U4	
On-Off Switch 3-pole	● ● ● ● ● T300	(for LT160)
On-Off Switch 4-pole	● ● ● ● ● T400	(for LT160)

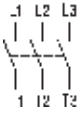
## Emergency-Stop-Main Switches for Panel Mounting, lockable IP66

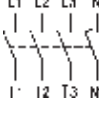
		max. padlocks	AC21 690V	AC23 3x400V	Plate	Type	Pack pcs.	Weight kg/pcs
<b>3-pole, padlock device SV1</b> 								
			20A	<b>7,5kW</b>	48 □ <sup>1)</sup>	LTS20 EHN1 A3	1	0,15
			25A	<b>10kW</b>	48 □ <sup>1)</sup>	LTS25 EHN1 A3	1	0,15
			32A	<b>12,5kW</b>	48 □ <sup>1)</sup>	LTS32 EHN1 A3	1	0,15
			40A	<b>16kW</b>	48 □ <sup>1)</sup>	LTS40 EHN1 A3	1	0,15
			63A	<b>22kW</b>	48 □ <sup>1)</sup>	LTS63 EHN1 A3	1	0,17
			80A	<b>22kW</b>	48 □ <sup>1)</sup>	LTS80 EHN1 A3	1	0,17
<b>4-pole, padlock device SV1</b> 								
			20A	<b>7,5kW</b>	48 □ <sup>1)</sup>	LTS20 EHN1 A4	1	0,19
			25A	<b>10kW</b>	48 □ <sup>1)</sup>	LTS25 EHN1 A4	1	0,19
			32A	<b>12,5kW</b>	48 □ <sup>1)</sup>	LTS32 EHN1 A4	1	0,19
			40A	<b>16kW</b>	48 □ <sup>1)</sup>	LTS40 EHN1 A4	1	0,19
			63A	<b>22kW</b>	48 □ <sup>1)</sup>	LTS63 EHN1 A4	1	0,21
			80A	<b>22kW</b>	48 □ <sup>1)</sup>	LTS80 EHN1 A4	1	0,21
<b>6-pole, 8-pole</b>						on request		
<b>3-pole, padlock device SV4(34)</b> 								
			20A	<b>7,5kW</b>	64 □ <sup>2)</sup>	LTS20 EHN4 A3	1	0,17
			25A	<b>10kW</b>	64 □ <sup>2)</sup>	LTS25 EHN4 A3	1	0,17
			32A	<b>12,5kW</b>	64 □ <sup>2)</sup>	LTS32 EHN4 A3	1	0,17
			40A	<b>16kW</b>	64 □ <sup>2)</sup>	LTS40 EHN4 A3	1	0,17
			63A	<b>22kW</b>	64 □ <sup>2)</sup>	LTS63 EHN4 A3	1	0,19
			80A	<b>22kW</b>	64 □ <sup>2)</sup>	LTS80 EHN4 A3	1	0,19
			85A	<b>30kW</b>	64 □ <sup>2)</sup>	LTS85 EHN4 A3	1	
			100A	<b>37kW</b>	64 □ <sup>2)</sup>	LTS100 EHN4 A3	1	
			125A	<b>45kW</b>	64 □ <sup>2)</sup>	LTS125 EHN4 A3	1	
			160A	<b>55kW</b>	88 □	LT160 EHN34 T300	1	1,16
<b>4-pole, padlock device SV4(34)</b> 								
			20A	<b>7,5kW</b>	64 □ <sup>2)</sup>	LTS20 EHN4 A4	1	0,20
			25A	<b>10kW</b>	64 □ <sup>2)</sup>	LTS25 EHN4 A4	1	0,20
			32A	<b>12,5kW</b>	64 □ <sup>2)</sup>	LTS32 EHN4 A4	1	0,20
			40A	<b>16kW</b>	64 □ <sup>2)</sup>	LTS40 EHN4 A4	1	0,20
			63A	<b>22kW</b>	64 □ <sup>2)</sup>	LTS63 EHN4 A4	1	0,23
			80A	<b>22kW</b>	64 □ <sup>2)</sup>	LTS80 EHN4 A4	1	0,23
			85A	<b>30kW</b>	64 □ <sup>2)</sup>	LTS85 EHN4 A4	1	
			100A	<b>37kW</b>	64 □ <sup>2)</sup>	LTS100 EHN4 A4	1	
			125A	<b>45kW</b>	64 □ <sup>2)</sup>	LTS125 EHN4 A4	1	
			160A	<b>55kW</b>	88 □	LT160 EHN34 T400	1	1,55

Add-on modules see page 6

1) Types with padlock device 64 □ type suffix **64**, ordering example: LTS32 EHN**164** A3, on request

2) Types with padlock device 88 □ type suffix **88**, ordering example: LTS32 EHN**488** A3, on request

## Emergency-Stop-Main Switches for Panel Mounting, lockable IP66

		max. padlocks	AC21 690V	AC23 3x400V	Plate	Type	Pack pcs.	Weight kg/pcs
<b>6-pole, padlock device SV4</b>								
			20A	<b>7,5kW</b>	64 □	LTS20 EHN4 A6	1	0,30
			25A	<b>10kW</b>	64 □	LTS25 EHN4 A6	1	0,30
			32A	<b>12,5kW</b>	64 □	LTS32 EHN4 A6	1	0,30
			40A	<b>16kW</b>	64 □	LTS40 EHN4 A6	1	0,30
			63A	<b>22kW</b>	64 □	LTS63 EHN4 A6	1	0,34
			80A	<b>22kW</b>	64 □	LTS80 EHN4 A6	1	0,34
<b>8-pole, padlock device SV4</b>								
			20A	<b>7,5kW</b>	64 □	LTS20 EHN4 A8	1	0,38
			25A	<b>10kW</b>	64 □	LTS25 EHN4 A8	1	0,38
			32A	<b>12,5kW</b>	64 □	LTS32 EHN4 A8	1	0,38
			40A	<b>16kW</b>	64 □	LTS40 EHN4 A8	1	0,38
			63A	<b>22kW</b>	64 □	LTS63 EHN4 A8	1	0,42
			80A	<b>22kW</b>	64 □	LTS80 EHN4 A8	1	0,42

## Changeover Switch with Padlock Device for Panel Mounting, lockable IP66















<b>3-pole, padlock device SV4</b>								
			20A	<b>7,5kW</b>	64 □	LTS20 EHN4 U3	1	0,30
			25A	<b>10kW</b>	64 □	LTS25 EHN4 U3	1	0,30
			32A	<b>12,5kW</b>	64 □	LTS32 EHN4 U3	1	0,30
			40A	<b>16kW</b>	64 □	LTS40 EHN4 U3	1	0,30
			63A	<b>22kW</b>	64 □	LTS63 EHN4 U3	1	0,34
			80A	<b>22kW</b>	64 □	LTS80 EHN4 U3	1	0,34
<b>4-pole, padlock device SV4</b>								
			20A	<b>7,5kW</b>	64 □	LTS20 EHN4 U4	1	0,38
			25A	<b>10kW</b>	64 □	LTS25 EHN4 U4	1	0,38
			32A	<b>12,5kW</b>	64 □	LTS32 EHN4 U4	1	0,38
			40A	<b>16kW</b>	64 □	LTS40 EHN4 U4	1	0,38
			63A	<b>22kW</b>	64 □	LTS63 EHN4 U4	1	0,42
			80A	<b>22kW</b>	64 □	LTS80 EHN4 U4	1	0,42

## Main Switches Emergency-Stop for Single Hole Mounting, lockable IP66



		max. padlocks	AC21 690V	AC23 3x400V	Plate	Type	Pack pcs.	Weight kg/pcs
<b>3-pole, padlock device SV1</b>								
			20A	<b>7,5kW</b>	48 □	LTS20 ZHN1 A3	1	0,16
			25A	<b>10kW</b>	48 □	LTS25 ZHN1 A3	1	0,16
			32A	<b>12,5kW</b>	48 □	LTS32 ZHN1 A3	1	0,16
			40A	<b>16kW</b>	48 □	LTS40 ZHN1 A3	1	0,16
<b>4-pole, padlock device SV1</b>								
			20A	<b>7,5kW</b>	48 □	LTS20 ZHN1 A4	1	0,20
			25A	<b>10kW</b>	48 □	LTS25 ZHN1 A4	1	0,20
			32A	<b>12,5kW</b>	48 □	LTS32 ZHN1 A4	1	0,20
			40A	<b>16kW</b>	48 □	LTS40 ZHN1 A4	1	0,20

Add-on modules see page 6

















## Add-on Modules for Main Switches, Panel Mounting and Single Hole Mounting

	for switch	Type	Pack pcs.	Weight kg/pcs	
	<b>4<sup>th</sup> Add-on Neutral Switching Pole</b>				
		LTS20 ... to LTS40 ... LTS63 ... , LTS80 ...	N40E N80E	1 1	0,035 0,042
	<b>Aux. Contact Block 1NO + 1NC</b>				
		LTS20 ... to LTS125 ...	LH11	1	0,02
	<b>Aux. Contact Block 1NO + 1NC Overlapping</b>				
		LTS20 ... to LTS125 ...	LH11X	1	0,02
	<b>Aux. Contact Block 2NC</b>				
		LTS20 ... to LTS125 ...	LH20V/02E	1	0,02
	<b>PE-Terminal</b>				
		LTS20 ... to LTS80 ... LT125 E.. to LT160 E..	PE80E LTXX-E/E	1 1	0,04 0,2
	<b>N-Terminal</b>				
		LTS20 ... to LTS80 ... LT125 E.. to LT160 E..	PEN80E LTXX-N/E	1 1	0,04 0,2
	<b>Terminal Cover 3-pole</b>				
		LTS20 ... to LTS80 ... LTS85.. to LTS125. LT125.. to LT160..	KLAD70 KLAD125 XX-KLAD3	1 1 1	0,005 0,01 0,02
	<b>Terminal Cover for 4<sup>th</sup> pole</b>				
	Mains Load circuit	LTS20 ... to LTS80.. LTS20 ... to LTS80..	KLAD70N KLAD70NI	1 1	0,002 0,002
	<b>Terminal Cover 4-pole</b>				
		LTS85.. to LTS125. LT125.. to LT160..	KLAD125 XX-KLAD4	1 1	0,01 0,02

## Accessories for Main Switches, Panel Mounting, Single Hole and Base Mounting

	for switch	Type	Pack pcs.	Weight kg/pcs
	<b>Additional Escutcheon Plate Yellow, Marked with: HAUPTSCHALTER</b>			
	for plate 48□ for plate 64□	LTS.. EHN1.. LTS.. .HN4..	A91501 E91501	1 1
	<b>Additional Escutcheon Plate Yellow, Marked with: MAIN SWITCH</b>			
	for plate 48□ for plate 64□	LTS.. EHN1.. LTS.. .HN4..	A91524 E91524	1 1







## Add-on Modules for Main Switches, Base and Rail Mounting

		for switch	Type	Pack pcs.	Weight kg/pcs
	<b>4<sup>th</sup> Add-on Neutral Switching Pole</b>				
		LTS20 ... , LTS40 ...	N40V	1	0,035
		LTS63 ... , LTS80 ...	N80V	1	0,042
	<b>Aux. Contact Block 1NO + 1NC</b>				
		LTS20 ... to LTS125 ...	LH11	1	0,02
	<b>Aux. Contact Block 1NO + 1NC Overlapping</b>				
		LTS20 ... to LTS125 ...	LH11X	1	0,02
	<b>Aux. Contact Block 2NO</b>				
		LTS20 ... to LTS125 ...	LH20V/02E	1	0,02
	<b>PE-Terminal</b>				
		LTS20 ... to LTS80 ...	PE80V	1	0,04
		LT125 .. to LT160 ..	LTXX-E/V	1	0,2
	<b>N-Terminal</b>				
		LTS20 ... to LTS80 ...	PEN80V	1	0,04
		LT125 .. to LT160 ..	LTXX-N/V	1	0,2
	<b>Terminal Cover 3-pole</b>				
		LTS20 ... to LTS40 ...	KLAD40	1	0,005
		LTS63 ... to LTS80 ...	KLAD70	1	0,005
		LTS85.. to LTS125. LT125.. to LT160..	KLAD125 XX-KLAD3	1 1	0,01 0,02
	<b>Terminal Cover for 4<sup>th</sup> pole</b>				
	Mains	LTS63., LTS80..	KLAD70N	1	0,002
	Load circuit	LTS63., LTS80..	KLAD70NI	1	0,002
	<b>Terminal Cover 4-pole</b>				
		LTS20 ... to LTS40 ...	KLAD40	1	0,005
		LTS85.. to LTS125. LT125.. to LT160..	KLAD125 XX-KLAD4	1 1	0,01 0,02
	<b>Tab Terminal 6,3 x 0,8mm</b>				
		LTS20 ... to LTS40 ...	LG11073	10	0,001

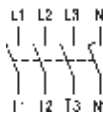

# Emergency-Stop-Main Switches, Base Mounting with Door Clutch for Single-Hole Mounting

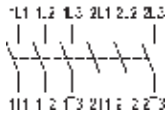
Depth X is adjustable (delivered with X<sub>max</sub> see below), IP66

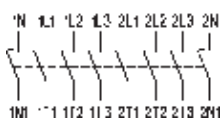
	max. padlocks	AC21 690V	AC23 3x400V	Plate	Type	Pack pcs.	Weight kg/pcs
<b>3-pole, padlock device SV4</b>							
 		20A	<b>7,5kW</b>	64 □ 1)	LTS20 VZVHN4 A3	1	0,19
		25A	<b>10kW</b>	64 □ 1)	LTS25 VZVHN4 A3	1	0,19
		32A	<b>12,5kW</b>	64 □ 1)	LTS32 VZVHN4 A3	1	0,19
		40A	<b>16kW</b>	64 □ 1)	LTS40 VZVHN4 A3	1	0,19
		63A	<b>22kW</b>	64 □ 1)	LTS63 VZVHN4 A3	1	0,22
		80A	<b>22kW</b>	64 □ 1)	LTS80 VZVHN4 A3	1	0,22
		85A	<b>30kW</b>	64 □ 1)	LTS85 VZVHN4 A3	1	
		100A	<b>37kW</b>	64 □ 1)	LTS100 VZVHN4 A3	1	
		125A	<b>45kW</b>	64 □ 1)	LTS125 VZVHN4 A3	1	
	<b>4-pole, padlock device SV4</b>						
 		20A	<b>7,5kW</b>	64 □ 1)	LTS20 VZVHN4 A4	1	0,20
		25A	<b>10kW</b>	64 □ 1)	LTS25 VZVHN4 A4	1	0,20
		32A	<b>12,5kW</b>	64 □ 1)	LTS32 VZVHN4 A4	1	0,20
		40A	<b>16kW</b>	64 □ 1)	LTS40 VZVHN4 A4	1	0,20
		63A	<b>22kW</b>	64 □ 1)	LTS63 VZVHN4 A4	1	0,26
		80A	<b>22kW</b>	64 □ 1)	LTS80 VZVHN4 A4	1	0,26
		85A	<b>30kW</b>	64 □ 1)	LTS85 VZVHN4 A4	1	
		100A	<b>37kW</b>	64 □ 1)	LTS100 VZVHN4 A4	1	
		125A	<b>45kW</b>	64 □ 1)	LTS125 VZVHN4 A4	1	
	<b>6-pole, padlock device SV4</b>						
 		20A	<b>7,5kW</b>	64 □ 1)	LTS20 VZVHN4 A6	1	0,32
		25A	<b>10kW</b>	64 □ 1)	LTS25 VZVHN4 A6	1	0,32
		32A	<b>12,5kW</b>	64 □ 1)	LTS32 VZVHN4 A6	1	0,32
		40A	<b>16kW</b>	64 □ 1)	LTS40 VZVHN4 A6	1	0,32
		63A	<b>22kW</b>	64 □ 1)	LTS63 VZVHN4 A6	1	0,37
		80A	<b>22kW</b>	64 □ 1)	LTS80 VZVHN4 A6	1	0,37
<b>8-pole, padlock device SV4</b>							
 		20A	<b>7,5kW</b>	64 □ 1)	LTS20 VZVHN4 A8	1	0,34
		25A	<b>10kW</b>	64 □ 1)	LTS25 VZVHN4 A8	1	0,34
		32A	<b>12,5kW</b>	64 □ 1)	LTS32 VZVHN4 A8	1	0,34
		40A	<b>16kW</b>	64 □ 1)	LTS40 VZVHN4 A8	1	0,34
		63A	<b>22kW</b>	64 □ 1)	LTS63 VZVHN4 A8	1	0,45
		80A	<b>22kW</b>	64 □ 1)	LTS80 VZVHN4 A8	1	0,45

## Depth Single Hole Mounting Ø22mm LTS.. VZV..

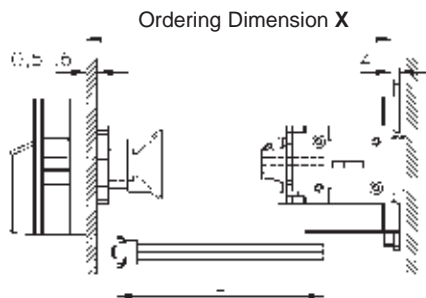

Type	X min	X max	L
LTS20-80 VZV.. 3, 4-pole	91 -	190	X - 40±3
LTS20-80 VZV.. 6, 8-pole	111 -	190	X - 60±3
LTS85-125 VZV.. 3, 4-pole			

## 4-Hole Mounting LTS.. V(HN).. (3, 4-pole)

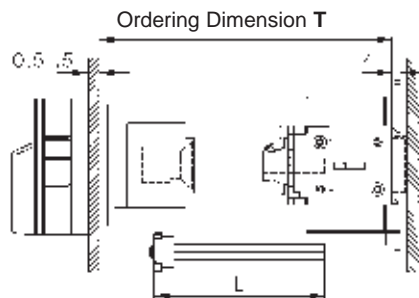



Type	T min	T max	L	Type	T min	T max
LTS20-80 VH..	111 -	190	T - 60±3	LT160 VH..	120 -	450
LTS85-125 VH..						

greater X- and T-Dimensions (max. 380mm for LTS..) on request



## Emergency-Stop-Main Switches, Base Mounting with Door Clutch, Padlock Device for Four-Hole Mounting

Depth X is adjustable (delivered with T<sub>max</sub> see page 8), IP66

	max. padlocks	AC21 690V	AC23 3x400V	Plate	Type	Pack pcs.	Weight kg/pcs
<b>3-pole, padlock device SV4(34)</b> 							
		20A	<b>7,5kW</b>	64 □ 1)	LTS20 VHN4 A3	1	0,20
		25A	<b>10kW</b>	64 □ 1)	LTS25 VHN4 A3	1	0,20
		32A	<b>12,5kW</b>	64 □ 1)	LTS32 VHN4 A3	1	0,20
		40A	<b>16kW</b>	64 □ 1)	LTS40 VHN4 A3	1	0,20
		63A	<b>22kW</b>	64 □ 1)	LTS63 VHN4 A3	1	0,24
		80A	<b>22kW</b>	64 □ 1)	LTS80 VHN4 A3	1	0,24
		85A	<b>30kW</b>	64 □ 1)	LTS85 VHN4 A3	1	
		100A	<b>37kW</b>	64 □ 1)	LTS100 VHN4 A3	1	
		125A	<b>45kW</b>	64 □ 1)	LTS125 VHN4 A3	1	
		160A	<b>55kW</b>	88 □	LT160 VHN34 T300	1	1,38
<b>4-pole, padlock device SV4(34)</b> 							
		20A	<b>7,5kW</b>	64 □ 1)	LTS20 VHN4 A4	1	0,21
		25A	<b>10kW</b>	64 □ 1)	LTS25 VHN4 A4	1	0,21
		32A	<b>12,5kW</b>	64 □ 1)	LTS32 VHN4 A4	1	0,21
		40A	<b>16kW</b>	64 □ 1)	LTS40 VHN4 A4	1	0,21
		63A	<b>22kW</b>	64 □ 1)	LTS63 VHN4 A4	1	0,28
		80A	<b>22kW</b>	64 □ 1)	LTS80 VHN4 A4	1	0,28
		85A	<b>30kW</b>	64 □ 1)	LTS85 VHN4 A4	1	
		100A	<b>37kW</b>	64 □ 1)	LTS100 VHN4 A4	1	
		125A	<b>45kW</b>	64 □ 1)	LTS125 VHN4 A4	1	
		160A	<b>55kW</b>	88 □	LT160 VHN34 T400	1	1,77
<b>6-pole, 8-pole Changeover Switch with Padlock Device for Base Mounting</b>					on request on request		

## Emergency-Stop-Main Switches, Base Mounting with Door Clutch for Single-Hole Mounting

Depth X is not adjustable, declare depth X when ordering, IP66

<b>4-pole, padlock device SV4</b> 							
		20A	<b>7,5kW</b>	64 □	LTS20 VZHN4 A4 X..	1	0,18
		25A	<b>10kW</b>	64 □	LTS25 VZHN4 A4 X..	1	0,18
		32A	<b>12,5kW</b>	64 □	LTS32 VZHN4 A4 X..	1	0,18
		40A	<b>16kW</b>	64 □	LTS40 VZHN4 A4 X..	1	0,18
		63A	<b>22kW</b>	64 □	LTS63 VZHN4 A4 X..	1	0,25
		80A	<b>22kW</b>	64 □	LTS80 VZHN4 A4 X..	1	0,25
<b>3-pole, 6-pole, 8-pole</b>					on request		

Declare depth X when ordering

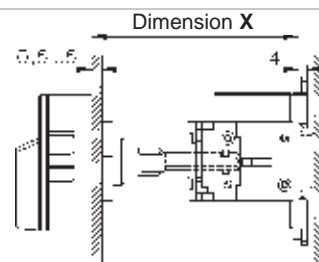

Type	Preference values for X
LTS.. VZH..	80, 85, 104, 129 (tolerance -3, +1,5)







Add-on modules see page 7

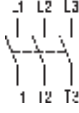

1) Types with padlock device 88 □ type suffix **88**, ordering example: LTS32 VHN4**88** A3, on request

## Emergency-Stop-Main Switches for Distribution Boards, lockable IP40

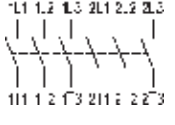

		max. padlocks	AC21 690V	AC23 3x400V	Plate	Type	Pack pcs.	Weight kg/pcs
<b>3-pole, padlock device SV1</b> 								
			20A	<b>7,5kW</b>	52x45	LTS20 SMAHN1 A3	1	0,15
			25A	<b>10kW</b>	52x45	LTS25 SMAHN1 A3	1	0,15
			32A	<b>12,5kW</b>	52x45	LTS32 SMAHN1 A3	1	0,15
			40A	<b>16kW</b>	52x45	LTS40 SMAHN1 A3	1	0,15
			63A	<b>22kW</b>	52x45	LTS63 SMAHN1 A3	1	0,18
			80A	<b>22kW</b>	52x45	LTS80 SMAHN1 A3	1	0,18
			85A	<b>30kW</b>		LTS85 SMAHN1 A3	1	
			100A	<b>37kW</b>		LTS100 SMAHN1 A3	1	
	125A	<b>45kW</b>		LTS125 SMAHN1 A3	1			

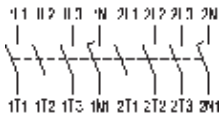

<b>4-pole, padlock device SV1</b> 								
			20A	<b>7,5kW</b>	52x45	LTS20 SMAHN1 A4	1	0,16
			25A	<b>10kW</b>	52x45	LTS25 SMAHN1 A4	1	0,16
			32A	<b>12,5kW</b>	52x45	LTS32 SMAHN1 A4	1	0,16
			40A	<b>16kW</b>	52x45	LTS40 SMAHN1 A4	1	0,16
			63A	<b>22kW</b>	52x45	LTS63 SMAHN1 A4	1	0,21
			80A	<b>22kW</b>	52x45	LTS80 SMAHN1 A4	1	0,21
			85A	<b>30kW</b>		LTS85 SMAHN1 A4	1	
			100A	<b>37kW</b>		LTS100 SMAHN1 A4	1	
	125A	<b>45kW</b>		LTS125 SMAHN1 A4	1			

<b>6-pole, padlock device SV1(64)</b> 								
			20A	<b>7,5kW</b>	52x45	LTS20 SMAHN1 A6	1	0,29
			25A	<b>10kW</b>	52x45	LTS25 SMAHN1 A6	1	0,29
			32A	<b>12,5kW</b>	52x45	LTS32 SMAHN1 A6	1	0,29
			40A	<b>16kW</b>	52x45	LTS40 SMAHN1 A6	1	0,29
			63A	<b>22kW</b>	97x45	LTS63 SMAHN1 A6 <sup>1)</sup>	1	0,34
			80A	<b>22kW</b>	97x45	LTS80 SMAHN1 A6 <sup>1)</sup>	1	0,34

<b>8-pole, padlock device SV164</b> 								
			20A	<b>7,5kW</b>	97x45	LTS20 SMAHN1 A8	1	0,31
			25A	<b>10kW</b>	97x45	LTS25 SMAHN1 A8	1	0,31
			32A	<b>12,5kW</b>	97x45	LTS32 SMAHN1 A8	1	0,31
			40A	<b>16kW</b>	97x45	LTS40 SMAHN1 A8	1	0,31
			63A	<b>22kW</b>	126x45	LTS63 SMAHN1 A8	1	0,42
			80A	<b>22kW</b>	126x45	LTS80 SMAHN1 A8	1	0,42

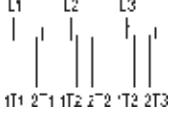
## Changeover Switch with Padlock Device for Distribution Boards, lockable IP40

<b>3-pole, padlock device SV164</b> 								
			20A	<b>7,5kW</b>	97x45	LTS20 SMAHN1 U3	1	0,29
			25A	<b>10kW</b>	97x45	LTS25 SMAHN1 U3	1	0,29
			32A	<b>12,5kW</b>	97x45	LTS32 SMAHN1 U3	1	0,29
			40A	<b>16kW</b>	97x45	LTS40 SMAHN1 U3	1	0,29
			63A	<b>22kW</b>	97x45	LTS63 SMAHN1 U3	1	0,34
			80A	<b>22kW</b>	97x45	LTS80 SMAHN1 U3	1	0,34

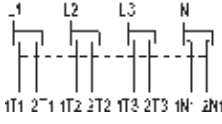
<b>4-pole, padlock device SV164</b> 								
			20A	<b>7,5kW</b>	97x45	LTS20 SMAHN1 U4	1	0,31
			25A	<b>10kW</b>	97x45	LTS25 SMAHN1 U4	1	0,31
			32A	<b>12,5kW</b>	97x45	LTS32 SMAHN1 U4	1	0,31
			40A	<b>16kW</b>	97x45	LTS40 SMAHN1 U4	1	0,31
			63A	<b>22kW</b>	126x45	LTS63 SMAHN1 U4	1	0,42
			80A	<b>22kW</b>	126x45	LTS80 SMAHN1 U4	1	0,42





**Add-on modules** see page 7

1) With padlock device SV164

## Maintenance and Safety Switches, in Plastic Enclosure, lockable IP65

	max. padlocks	AC21 690V	AC23 3x400V	Plate	Type	Pack pcs.	Weight kg/pcs
<b>3-pole, padlock device SV4(34)</b>							
		20A	<b>7,5kW</b>	64 □	LTS20 PFHN4 A3	1	0,32
		25A	<b>10kW</b>	64 □	LTS25 PFHN4 A3	1	0,32
		32A	<b>12,5kW</b>	64 □	LTS32 PFHN4 A3	1	0,32
		40A	<b>16kW</b>	64 □	LTS40 PFHN4 A3	1	0,32
		63A	<b>22kW</b>	64 □	LTS63 PFHN4 A3	1	0,60
		80A	<b>22kW</b>	64 □	LTS80 PFHN4 A3	1	0,60
		85A	<b>30kW</b>	64 □	LTS85 PFHN4 A3	1	
		100A	<b>37kW</b>	64 □	LTS100 PFHN4 A3	1	
		125A	<b>45kW</b>	64 □	LTS125 PFHN4 A3	1	
		160A	<b>55kW</b>	88 □	LT160 PFHN34 T300	1	2,09
<b>4-pole, padlock device SV4(34)</b>							
		20A	<b>7,5kW</b>	64 □	LTS20 PFHN4 A4	1	0,33
		25A	<b>10kW</b>	64 □	LTS25 PFHN4 A4	1	0,33
		32A	<b>12,5kW</b>	64 □	LTS32 PFHN4 A4	1	0,33
		40A	<b>16kW</b>	64 □	LTS40 PFHN4 A4	1	0,33
		63A	<b>22kW</b>	64 □	LTS63 PFHN4 A4	1	0,64
		80A	<b>22kW</b>	64 □	LTS80 PFHN4 A4	1	0,64
		85A	<b>30kW</b>	64 □	LTS85 PFHN4 A4	1	
		100A	<b>37kW</b>	64 □	LTS100 PFHN4 A4	1	
		125A	<b>45kW</b>	64 □	LTS125 PFHN4 A4	1	
		160A	<b>55kW</b>	88 □	LT160 PFHN34 T400	1	2,47
<b>6-pole, padlock device SV4</b>							
		20A	<b>7,5kW</b>	64 □	LTS20 PFHN4 A6	1	1,39
		25A	<b>10kW</b>	64 □	LTS25 PFHN4 A6	1	1,39
		32A	<b>12,5kW</b>	64 □	LTS32 PFHN4 A6	1	1,39
		40A	<b>16kW</b>	64 □	LTS40 PFHN4 A6	1	1,39
		63A	<b>22kW</b>	64 □	LTS63 PFHN4 A6	1	1,42
		80A	<b>22kW</b>	64 □	LTS80 PFHN4 A6	1	1,42
<b>8-pole, padlock device SV4</b>							
		20A	<b>7,5kW</b>	64 □	LTS20 PFHN4 A8	1	1,44
		25A	<b>10kW</b>	64 □	LTS25 PFHN4 A8	1	1,44
		32A	<b>12,5kW</b>	64 □	LTS32 PFHN4 A8	1	1,44
		40A	<b>16kW</b>	64 □	LTS40 PFHN4 A8	1	1,44
		63A	<b>22kW</b>	64 □	LTS63 PFHN4 A8	1	1,50
		80A	<b>22kW</b>	64 □	LTS80 PFHN4 A8	1	1,50
<b>Changeover Switch with Padlock Device, lockable IP65</b>							
<b>3-pole, padlock device SV4</b>							
		20A	<b>7,5kW</b>	64 □	LTS20 PFHN4 U3	1	1,39
		25A	<b>10kW</b>	64 □	LTS25 PFHN4 U3	1	1,39
		32A	<b>12,5kW</b>	64 □	LTS32 PFHN4 U3	1	1,39
		40A	<b>16kW</b>	64 □	LTS40 PFHN4 U3	1	1,39
		63A	<b>22kW</b>	64 □	LTS63 PFHN4 U3	1	1,42
		80A	<b>22kW</b>	64 □	LTS80 PFHN4 U3	1	1,42
<b>4-pole, padlock device SV4</b>							
		20A	<b>7,5kW</b>	64 □	LTS20 PFHN4 U4	1	1,44
		25A	<b>10kW</b>	64 □	LTS25 PFHN4 U4	1	1,44
		32A	<b>12,5kW</b>	64 □	LTS32 PFHN4 U4	1	1,44
		40A	<b>16kW</b>	64 □	LTS40 PFHN4 U4	1	1,44
		63A	<b>22kW</b>	64 □	LTS63 PFHN4 U4	1	1,50
		80A	<b>22kW</b>	64 □	LTS80 PFHN4 U4	1	1,50

## Main Switches for Panel Mounting, lockable IP66





	max. padlocks	AC21 690V	AC23 3x400V	Plate	Type	Pack pcs.	Weight kg/pcs
<b>3-pole, padlock device SV1</b> 							
		20A	<b>7,5kW</b>	48 □ <sup>1)</sup>	LTS20 EH1 A3	1	0,15
		25A	<b>10kW</b>	48 □ <sup>1)</sup>	LTS25 EH1 A3	1	0,15
		32A	<b>12,5kW</b>	48 □ <sup>1)</sup>	LTS32 EH1 A3	1	0,15
		40A	<b>16kW</b>	48 □ <sup>1)</sup>	LTS40 EH1 A3	1	0,15
		63A	<b>22kW</b>	48 □ <sup>1)</sup>	LTS63 EH1 A3	1	0,17
		80A	<b>22kW</b>	48 □ <sup>1)</sup>	LTS80 EH1 A3	1	0,17
<b>4-pole, padlock device SV1</b> 							
		20A	<b>7,5kW</b>	48 □ <sup>1)</sup>	LTS20 EH1 A4	1	0,19
		25A	<b>10kW</b>	48 □ <sup>1)</sup>	LTS25 EH1 A4	1	0,19
		32A	<b>12,5kW</b>	48 □ <sup>1)</sup>	LTS32 EH1 A4	1	0,19
		40A	<b>16kW</b>	48 □ <sup>1)</sup>	LTS40 EH1 A4	1	0,19
		63A	<b>22kW</b>	48 □ <sup>1)</sup>	LTS63 EH1 A4	1	0,21
		80A	<b>22kW</b>	48 □ <sup>1)</sup>	LTS80 EH1 A4	1	0,21
<b>6-pole, 8-pole</b>					on request		
<b>3-pole, padlock device SV4(34)</b> 							
		20A	<b>7,5kW</b>	64 □ <sup>2)</sup>	LTS20 EH4 A3	1	0,17
		25A	<b>10kW</b>	64 □ <sup>2)</sup>	LTS25 EH4 A3	1	0,17
		32A	<b>12,5kW</b>	64 □ <sup>2)</sup>	LTS32 EH4 A3	1	0,17
		40A	<b>16kW</b>	64 □ <sup>2)</sup>	LTS40 EH4 A3	1	0,17
		63A	<b>22kW</b>	64 □ <sup>2)</sup>	LTS63 EH4 A3	1	0,19
		80A	<b>22kW</b>	64 □ <sup>2)</sup>	LTS80 EH4 A3	1	0,19
		80A	<b>30kW</b>	64 □ <sup>2)</sup>	LTS85 EH4 A3	1	
		100A	<b>37kW</b>	64 □ <sup>2)</sup>	LTS100 EH4 A3	1	
		125A	<b>45kW</b>	64 □ <sup>2)</sup>	LTS125 EH4 A3	1	
		160A	<b>55kW</b>	88 □	LT160 EH34 T300	1	1,16
<b>4-pole, padlock device SV4(34)</b> 							
		20A	<b>7,5kW</b>	64 □ <sup>2)</sup>	LTS20 EH4 A4	1	0,20
		25A	<b>10kW</b>	64 □ <sup>2)</sup>	LTS25 EH4 A4	1	0,20
		32A	<b>12,5kW</b>	64 □ <sup>2)</sup>	LTS32 EH4 A4	1	0,20
		40A	<b>16kW</b>	64 □ <sup>2)</sup>	LTS40 EH4 A4	1	0,20
		63A	<b>22kW</b>	64 □ <sup>2)</sup>	LTS63 EH4 A4	1	0,23
		80A	<b>22kW</b>	64 □ <sup>2)</sup>	LTS80 EH4 A4	1	0,23
		80A	<b>30kW</b>	64 □ <sup>2)</sup>	LTS85 EH4 A4	1	
		100A	<b>37kW</b>	64 □ <sup>2)</sup>	LTS100 EH4 A4	1	
		125A	<b>45kW</b>	64 □ <sup>2)</sup>	LTS125 EH4 A4	1	
		160A	<b>55kW</b>	88 □	LT160 EH34 T400	1	1,55
<b>6-pole, 8-pole</b>					on request		

**Add-on modules** see page 6

1) Types with padlock device 64 □ type suffix **64**, ordering example: LTS32 EH1**64** A3, on request

2) Types with padlock device 88 □ type suffix **88**, ordering example: LTS32 EH4**88** A3, on request

# Main Switches, Base Mounting with Door Clutch, Padlock Device for Single-Hole Mounting Depth X is adjustable (delivered with X<sub>max</sub> see below), IP66

	max. padlocks	AC21 690V	AC23 3x400V	Plate	Type	Pack pcs.	Weight kg/pcs
<b>3-pole, padlock device SV4</b> 							
		20A	<b>7,5kW</b>	64 □ 1)	LTS20 VZVH4 A3	1	0,19
		25A	<b>10kW</b>	64 □ 1)	LTS25 VZVH4 A3	1	0,19
		32A	<b>12,5kW</b>	64 □ 1)	LTS32 VZVH4 A3	1	0,19
		40A	<b>16kW</b>	64 □ 1)	LTS40 VZVH4 A3	1	0,19
		63A	<b>22kW</b>	64 □ 1)	LTS63 VZVH4 A3	1	0,22
		80A	<b>22kW</b>	64 □ 1)	LTS80 VZVH4 A3	1	0,22
		85A	<b>30kW</b>	64 □ 1)	LTS85 VZVH4 A3	1	
		100A	<b>37kW</b>	64 □ 1)	LTS100 VZVH4 A3	1	
		125A	<b>45kW</b>	64 □ 1)	LTS125 VZVH4 A3	1	
<b>4-pole, padlock device SV4</b> 							
		20A	<b>7,5kW</b>	64 □ 1)	LTS20 VZVH4 A4	1	0,20
		25A	<b>10kW</b>	64 □ 1)	LTS25 VZVH4 A4	1	0,20
		32A	<b>12,5kW</b>	64 □ 1)	LTS32 VZVH4 A4	1	0,20
		40A	<b>16kW</b>	64 □ 1)	LTS40 VZVH4 A4	1	0,20
		63A	<b>22kW</b>	64 □ 1)	LTS63 VZVH4 A4	1	0,26
		80A	<b>22kW</b>	64 □ 1)	LTS80 VZVH4 A4	1	0,26
		85A	<b>30kW</b>	64 □ 1)	LTS85 VZVH4 A4	1	
		100A	<b>37kW</b>	64 □ 1)	LTS100 VZVH4 A4	1	
		125A	<b>45kW</b>	64 □ 1)	LTS125 VZVH4 A4	1	
<b>6-pole, padlock device SV4</b> 							
		20A	<b>7,5kW</b>	64 □ 1)	LTS20 VZVH4 A6	1	0,32
		25A	<b>10kW</b>	64 □ 1)	LTS25 VZVH4 A6	1	0,32
		32A	<b>12,5kW</b>	64 □ 1)	LTS32 VZVH4 A6	1	0,32
		40A	<b>16kW</b>	64 □ 1)	LTS40 VZVH4 A6	1	0,32
		63A	<b>22kW</b>	64 □ 1)	LTS63 VZVH4 A6	1	0,37
		80A	<b>22kW</b>	64 □ 1)	LTS80 VZVH4 A6	1	0,37
<b>8-pole, padlock device SV4</b> 							
		20A	<b>7,5kW</b>	64 □ 1)	LTS20 VZVH4 A8	1	0,34
		25A	<b>10kW</b>	64 □ 1)	LTS25 VZVH4 A8	1	0,34
		32A	<b>12,5kW</b>	64 □ 1)	LTS32 VZVH4 A8	1	0,34
		40A	<b>16kW</b>	64 □ 1)	LTS40 VZVH4 A8	1	0,34
		63A	<b>22kW</b>	64 □ 1)	LTS63 VZVH4 A8	1	0,45
		80A	<b>22kW</b>	64 □ 1)	LTS80 VZVH4 A8	1	0,45

## Depth Single Hole Mounting Ø22mm LTS.. VZV..

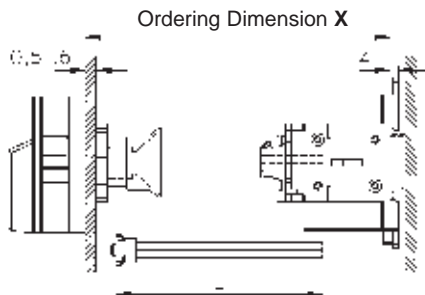

Type	X min	X max	L
LTS20-80 VZV.. 3, 4-pole	91 -	190	X - 40±3
LTS20-80 VZV.. 6, 8-pole	111 -	190	X - 60±3
LTS85-125 VZV.. 3, 4-pole			

## 4-Hole Mounting LTS.. V(H).. (3, 4-pole)

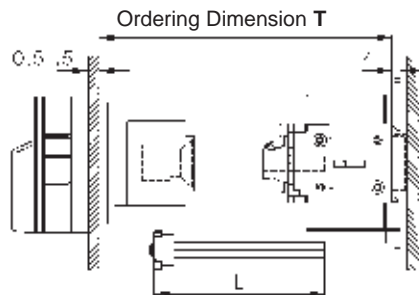



Type	T min	T max	L	Type	T min	T max
LTS20-80 VH..	111 -	190	T - 60±3	LT160 VH..	120 -	450
LTS85-125 VH..						

greater X- and T-Dimensions (max. 380mm for LTS..) on request



## Main Switches, Base Mounting with Door Clutch, Padlock Device for Four-Hole Mounting Depth X is adjustable (delivered with T<sub>max</sub> see page 13), IP66

	max. padlocks	AC21 690V	AC23 3x400V	Plate	Type	Pack pcs.	Weight kg/pcs
<b>3-pole, padlock device SV4(34)</b> 							
		20A	<b>7,5kW</b>	64 □ 1)	LTS20 VH4 A3	1	0,20
		25A	<b>10kW</b>	64 □ 1)	LTS25 VH4 A3	1	0,20
		32A	<b>12,5kW</b>	64 □ 1)	LTS32 VH4 A3	1	0,20
		40A	<b>16kW</b>	64 □ 1)	LTS40 VH4 A3	1	0,20
		63A	<b>22kW</b>	64 □ 1)	LTS63 VH4 A3	1	0,24
		80A	<b>22kW</b>	64 □ 1)	LTS80 VH4 A3	1	0,24
		85A	<b>30kW</b>	64 □ 1)	LTS85 VH4 A3	1	
		100A	<b>37kW</b>	64 □ 1)	LTS100 VH4 A3	1	
		125A	<b>45kW</b>	64 □ 1)	LTS125 VH4 A3	1	
		160A	<b>55kW</b>	88 □	LT160 VH34 T300	1	1,38
<b>4-pole, padlock device SV4(34)</b> 							
		20A	<b>7,5kW</b>	64 □ 1)	LTS20 VH4 A4	1	0,21
		25A	<b>10kW</b>	64 □ 1)	LTS25 VH4 A4	1	0,21
		32A	<b>12,5kW</b>	64 □ 1)	LTS32 VH4 A4	1	0,21
		40A	<b>16kW</b>	64 □ 1)	LTS40 VH4 A4	1	0,21
		63A	<b>22kW</b>	64 □ 1)	LTS63 VH4 A4	1	0,28
		80A	<b>22kW</b>	64 □ 1)	LTS80 VH4 A4	1	0,28
		85A	<b>30kW</b>	64 □ 1)	LTS85 VH4 A4	1	
		100A	<b>37kW</b>	64 □ 1)	LTS100 VH4 A4	1	
		125A	<b>45kW</b>	64 □ 1)	LTS125 VH4 A4	1	
		160A	<b>55kW</b>	88 □	LT160 VH34 T400	1	1,77
<b>6-pole, 8-pole</b>	on request						

## Emergency-Stop-Main Switches, Base Mounting with Door Clutch for Single-Hole Mounting Depth X is not adjustable, declare depth X when ordering, IP66

<b>4-pole, padlock device SV4</b> 							
		20A	<b>7,5kW</b>	64 □	LTS20 VZHN4 A4 X..	1	0,18
		25A	<b>10kW</b>	64 □	LTS25 VZHN4 A4 X..	1	0,18
		32A	<b>12,5kW</b>	64 □	LTS32 VZHN4 A4 X..	1	0,18
		40A	<b>16kW</b>	64 □	LTS40 VZHN4 A4 X..	1	0,18
		63A	<b>22kW</b>	64 □	LTS63 VZHN4 A4 X..	1	0,25
		80A	<b>22kW</b>	64 □	LTS80 VZHN4 A4 X..	1	0,25

**3-pole, 6-pole, 8-pole** on request

Declare depth X when ordering

Type	Preference values for X
LTS.. VZH..	80, 85, 104, 129 (tolerance -3, +1,5)

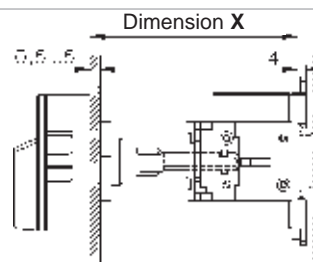









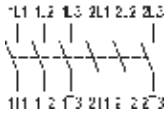

**Add-on modules** see page 7

- Types with padlock device 88 □ type suffix **88**, ordering example: LTS32 VH4**88** A3, on request
- LT80.. to LT160 protection degree IP40

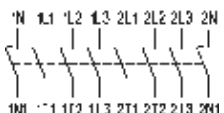

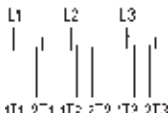

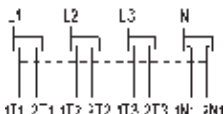
## Switch Disconnectors for Panel Mounting, IP66







	AC21 690V	AC23 3x400V	Plate	Type	Pack pcs.	Weight kg/pcs
<b>On-Off Switches 3-pole</b>						
 	20A	<b>7,5kW</b>	48 □	LTS20 E A3	1	0,15
	25A	<b>10kW</b>	48 □	LTS25 E A3	1	0,15
	32A	<b>12,5kW</b>	48 □	LTS32 E A3	1	0,15
	40A	<b>16kW</b>	48 □	LTS40 E A3	1	0,15
	63A	<b>22kW</b>	48 □	LTS63 E A3	1	0,17
	80A	<b>22kW</b>	48 □	LTS80 E A3	1	0,17
	85A	<b>30kW</b>	64 □	LTS85 E A3	1	
	100A	<b>37kW</b>	64 □	LTS100 E A3	1	
	125A	<b>45kW</b>	64 □	LTS125 E A3	1	
	160A	<b>55kW</b>	88 □	LT160 E T300	1	1,10
<b>On-Off Switches 4-pole</b>						
 	20A	<b>7,5kW</b>	48 □	LTS20 E A4	1	0,18
	25A	<b>10kW</b>	48 □	LTS25 E A4	1	0,18
	32A	<b>12,5kW</b>	48 □	LTS32 E A4	1	0,18
	40A	<b>16kW</b>	48 □	LTS40 E A4	1	0,18
	63A	<b>22kW</b>	48 □	LTS63 E A4	1	0,21
	80A	<b>22kW</b>	48 □	LTS80 E A4	1	0,21
	85A	<b>30kW</b>	64 □	LTS85 E A4	1	
	100A	<b>37kW</b>	64 □	LTS100 E A4	1	
	125A	<b>45kW</b>	64 □	LTS125 E A4	1	
	160A	<b>55kW</b>	88 □	LT160 E T400	1	1,50
<b>On-Off Switches 6-pole</b>						
 	20A	<b>7,5kW</b>	64 □	LTS20 E A6	1	0,30
	25A	<b>10kW</b>	64 □	LTS25 E A6	1	0,30
	32A	<b>12,5kW</b>	64 □	LTS32 E A6	1	0,30
	40A	<b>16kW</b>	64 □	LTS40 E A6	1	0,30
	63A	<b>22kW</b>	64 □	LTS63 E A6	1	0,36
	80A	<b>22kW</b>	64 □	LTS80 E A6	1	0,36
<b>On-Off Switches 8-pole</b>						
 	20A	<b>7,5kW</b>	64 □	LTS20 E A8	1	0,32
	25A	<b>10kW</b>	64 □	LTS25 E A8	1	0,32
	32A	<b>12,5kW</b>	64 □	LTS32 E A8	1	0,32
	40A	<b>16kW</b>	64 □	LTS40 E A8	1	0,32
	63A	<b>22kW</b>	64 □	LTS63 E A8	1	0,43
	80A	<b>22kW</b>	64 □	LTS80 E A8	1	0,43
<b>Changeover Switches 3-pole</b>						
 	20A	<b>7,5kW</b>	64 □	LTS20 E U3	1	0,31
	25A	<b>10kW</b>	64 □	LTS25 E U3	1	0,31
	32A	<b>12,5kW</b>	64 □	LTS32 E U3	1	0,31
	40A	<b>16kW</b>	64 □	LTS40 E U3	1	0,31
	63A	<b>22kW</b>	64 □	LTS63 E U3	1	0,37
	80A	<b>22kW</b>	64 □	LTS80 E U3	1	0,37
<b>Changeover Switches 4-pole</b>						
 	20A	<b>7,5kW</b>	64 □	LTS20 E U4	1	0,33
	25A	<b>10kW</b>	64 □	LTS25 E U4	1	0,33
	32A	<b>12,5kW</b>	64 □	LTS32 E U4	1	0,33
	40A	<b>16kW</b>	64 □	LTS40 E U4	1	0,33
	63A	<b>22kW</b>	64 □	LTS63 E U4	1	0,44
	80A	<b>22kW</b>	64 □	LTS80 E U4	1	0,44

## Switch Disconnectors for Base Mounting on request

## Switch Disconnectors in Plastic Enclosure, IP65

	AC21 690V	AC23 3x400V	Plate	Type	Pack pcs.	Weight kg/pcs
<b>On-Off Switches 3-pole</b> 	20A	<b>7,5kW</b>	64 □	LTS20 PF A3	1	0,30
	25A	<b>10kW</b>	64 □	LTS25 PF A3	1	0,30
	32A	<b>12,5kW</b>	64 □	LTS30 PF A3	1	0,30
	40A	<b>16kW</b>	64 □	LTS40 PF A3	1	0,30
	63A	<b>22kW</b>	64 □	LTS63 PF A3	1	0,58
	80A	<b>22kW</b>	64 □	LTS80 PF A3	1	0,58
<b>On-Off Switches 4-pole</b> 	20A	<b>7,5kW</b>	64 □	LTS20 PF A4	1	0,31
	25A	<b>10kW</b>	64 □	LTS25 PF A4	1	0,31
	32A	<b>12,5kW</b>	64 □	LTS32 PF A4	1	0,31
	40A	<b>16kW</b>	64 □	LTS40 PF A4	1	0,31
	63A	<b>22kW</b>	64 □	LTS63 PF A4	1	0,62
	80A	<b>22kW</b>	64 □	LTS80 PF A4	1	0,62

## Switch Disconnectors for Distribution Boards, IP40

<b>On-Off Switches 3-pole</b> 	20A	<b>7,5kW</b>	52x45	LTS20 SMA A3	1	0,15
	25A	<b>10kW</b>	52x45	LTS25 SMA A3	1	0,15
	32A	<b>12,5kW</b>	52x45	LTS30 SMA A3	1	0,15
	40A	<b>16kW</b>	52x45	LTS40 SMA A3	1	0,15
	63A	<b>22kW</b>	52x45	LTS63 SMA A3	1	0,17
	80A	<b>22kW</b>	52x45	LTS80 SMA A3	1	0,17
<b>On-Off Switches 4-pole</b> 	20A	<b>7,5kW</b>	52x45	LTS20 SMA A4	1	0,16
	25A	<b>10kW</b>	52x45	LTS25 SMA A4	1	0,16
	32A	<b>12,5kW</b>	52x45	LTS32 SMA A4	1	0,16
	40A	<b>16kW</b>	52x45	LTS40 SMA A4	1	0,16
	63A	<b>22kW</b>	52x45	LTS63 SMA A4	1	0,21
	80A	<b>22kW</b>	52x45	LTS80 SMA A4	1	0,21
<b>On-Off Switches 6-pole</b> 	20A	<b>7,5kW</b>	52x45	LTS20 SMA A6	1	0,29
	25A	<b>10kW</b>	52x45	LTS25 SMA A6	1	0,29
	32A	<b>12,5kW</b>	52x45	LTS30 SMA A6	1	0,29
	40A	<b>16kW</b>	52x45	LTS40 SMA A6	1	0,29
	63A	<b>22kW</b>	97x45	LTS63 SMA A6	1	0,34
	80A	<b>22kW</b>	97x45	LTS80 SMA A6	1	0,34
<b>On-Off Switches 8-pole</b> 	20A	<b>7,5kW</b>	97x45	LTS20 SMA A8	1	0,31
	25A	<b>10kW</b>	97x45	LTS25 SMA A8	1	0,31
	32A	<b>12,5kW</b>	97x45	LTS32 SMA A8	1	0,31
	40A	<b>16kW</b>	97x45	LTS40 SMA A8	1	0,31
	63A	<b>22kW</b>	126x45	LTS63 SMA A8	1	0,42
	80A	<b>22kW</b>	126x45	LTS80 SMA A8	1	0,42
<b>Changeover Switches 3-pole</b> 	20A	<b>7,5kW</b>	97x45	LTS20 SMA U3	1	0,30
	25A	<b>10kW</b>	97x45	LTS25 SMA U3	1	0,30
	32A	<b>12,5kW</b>	97x45	LTS32 SMA U3	1	0,30
	40A	<b>16kW</b>	97x45	LTS40 SMA U3	1	0,30
	63A	<b>22kW</b>	97x45	LTS63 SMA U3	1	0,35
	80A	<b>22kW</b>	97x45	LTS80 SMA U3	1	0,35
<b>Changeover Switches 4-pole</b> 	20A	<b>7,5kW</b>	97x45	LTS20 SMA U4	1	0,32
	25A	<b>10kW</b>	97x45	LTS25 SMA U4	1	0,32
	32A	<b>12,5kW</b>	97x45	LTS32 SMA U4	1	0,32
	40A	<b>16kW</b>	97x45	LTS40 SMA U4	1	0,32
	63A	<b>22kW</b>	126x45	LTS63 SMA U4	1	0,43
	80A	<b>22kW</b>	126x45	LTS80 SMA U4	1	0,43

## Technical Data

Data according to IEC 947-3, IEC 947-5-1, VDE 0660, EN 60947-3, EN 60947-5-1

Type		LTS20	LTS25	LTS32	LTS40	LTS63	LTS80	LTS85	LTS100	LTS125	LT160
<b>Main contacts</b>											
Rated thermal current $I_{th}$ open	A	20	25	32	40	63	80	85	100	125	160
Rated thermal current $I_{the}$ enclosed	A	20	25	32	40	63	80	85	100	125	160
Rated insulation voltage $U_i$ <sup>1)</sup>	V	690	690	690	690	690	690	1000 <sup>5)</sup>	1000 <sup>5)</sup>	1000 <sup>5)</sup>	1000 <sup>3)</sup>
Rated operational current $I_e$ AC21A	A	20	25	32	40	63	80	85	100	125	160
Making capacity $I_{eff}$ 3x380-440V	A	160	190	220	300	370	440	600	725	850	1050
Breaking capacity 3x220-240V	A	160	180	200	250	330	380	480	580	680	900
3x380-440V	A	160	180	200	250	330	380	480	580	680	850
3x660-690V	A	80	110	140	170	190	220	250	330	420	340
Disconnection property performed up to	V	690	690	690	690	690	690	1000	1000	1000	1000 <sup>3)</sup>
Motor Switch AC3 3x400V	A	12	16	23	30	37	37	45	60	72	85
Motor Switch AC3 3x220-240V	kW	3	4	5,5	7,5	11	11	15	18,5	22	30
Direct switching of single motors 3x380-440V	kW	5,5	7,5	11	15	18,5	18,5	22	30	37	45
3x660-690V	kW	5,5	7,5	11	15	18,5	18,5	22	30	37	37
Main Switch AC23 3x400V	A	16	20	25	32	45	45	60	72	85	110
Motor Switch, AC23A, 3x220-240V	kW	4	5,5	7,5	9	15	15	18,5	22	30	30
Main Switch, AC23B, 3x380-440V	kW	7,5	10	12,5	16	22	22	30	37	45	55
Safety Switch 3x660-690V	kW	5,5	7,5	11	15	18,5	18,5	22	30	37	37
Rated conditional short-circuit current	$kA_{eff}$	10	10	10	10	10	10	10	10	10	30
Max. fuse size gL (gG)	A	25	35	40	50	63	80	100	100	125	160
Mechanical life	x10 <sup>3</sup>	200	200	200	200	100	100	100	100	100	100
Rated short-time withstand current (1sec. current)	A	250	300	400	500	600	850	1000	1200	1500	3000
<b>Maximum cable cross sections</b>											
solid	mm <sup>2</sup>	10	10	10	10	25	25	50	50	50	95
	AWG	8	8	8	8	4	4	0	0	0	3/0
flexible (+ multicore cable end)	mm <sup>2</sup>	6	6	6	6	16	16	35	35	35	70
	AWG	10	10	10	10	6	6	2	2	2	2/0
Size of terminal screw		M3,5	M3,5	M3,5	M3,5	M5	M5	M6	M6	M6	M10
Tightening torque	Nm	0,8-1,7	0,8-1,7	0,8-1,7	0,8-1,7	2-4	2-4	3,5-4,5	3,5-4,5	3,5-4,5	14
	lb.inch	7-15	7-15	7-15	7-15	18-35	18-35	31-40	31-40	31-40	124
<b>Auxiliary contacts</b>											
Rated insulation voltage $U_i$ <sup>1)</sup>	V	690	690	690	690	690	690	690	690	690	690
Rated thermal current $I_{th}$ , $I_{the}$	A	10	10	10	10	10	10	16	16	16	16
Switching capacity AC15 220-240V	A	2,5	2,5	2,5	2,5	2,5	2,5	6	6	6	6
AC15 380-440V	A	1,5	1,5	1,5	1,5	1,5	1,5	3	3	4	4
Rated conditional short-circuit current	$kA_{eff}$	3	3	3	3	3	3	3	3	3	3
Max. short circuit protection gL (gG)	A	10	10	10	10	10	10	16	16	16	16
<b>Maximum cable cross sections</b>											
solid	mm <sup>2</sup>	2,5	2,5	2,5	2,5	2,5	2,5	4	4	4	4
	AWG	12	12	12	12	12	12	12	12	12	12
flexible (+ multicore cable end)	mm <sup>2</sup>	2,5	2,5	2,5	2,5	2,5	2,5	2,5	2,5	2,5	2,5
	AWG	14	14	14	14	14	14	14	14	14	14

### Data according to UL und cUL

Type		LTS20	LTS25	LTS32	LTS40	LTS63	LTS80	LTS85	LTS100	LTS125	LT160
Rated voltage	V	600	600	600	600	600	600	600	600	600	600
Ampere-Rating "General use"	A	20	25	32	40	63	80	85	100	125	200
DOL-Rating 3-phase 110-120V	HP	1	1,5	2	2	3	5	7,5	10	15	20
220-240V	HP	3	5	5	5	10	10	20	25	30	40
440-480V	HP	7,5	10	10	10	20	20	40	50	60	60
550-600V	HP	10	10	15	15	25	25	50	60	60	60
DOL-Rating 1-phase 110-120V	HP	1	1	1	1	2	2	3	5	7,5	-
200-208V	HP	1	2	2	2	3	3	7,5	10	10	-
220-240V	HP	2	2	3	3	5	5	10	15	15	-
Fuse size (RK5) Manual Motor Controller	A	40	50	50	70	90	110	200	250	300	400 <sup>4)</sup>
5kA / 600V Motor Disconnect	A	40	50	50	50	70	70	-	-	-	400 <sup>4)</sup>

1) suitable for: earthed-neutral systems, overvoltage category I to III, pollution degree 3 (standard-industry);  $U_{imp} = 6kV$ . Data for other conditions on request

2) the values after the slash are valid for switches 6-pole or more

3) Suitable for no load applications (AC20A) above 690V

4) Fuse RK1 / 10kA / 600V

5)  $U_{imp} = 8kV$

6) 110A enclosure PF2

# Dimensions (mm)

## Main Switches, Switch Disconnectors LT(S)..

**Panel mounting LT(S).. E(HN)..**  
ON-OFF Switches 3-pole, 4-pole

ON-OFF Switches 6-pole, 8-pole  
Changeover Switches 3-pole, 4-pole

Mounting holes

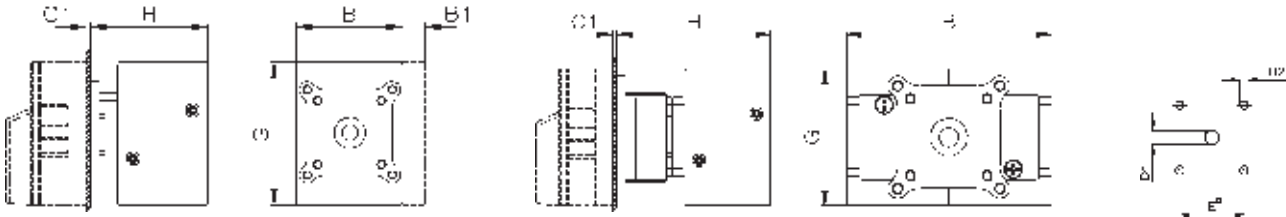

**Single hole mounting LTS.. Z(HN)..**  
ON-OFF Switches 3-pole, 4-pole

Mounting holes

**MMounting of add-on modules LTS20 - LTS80**  
Panel mounting, Single hole mounting

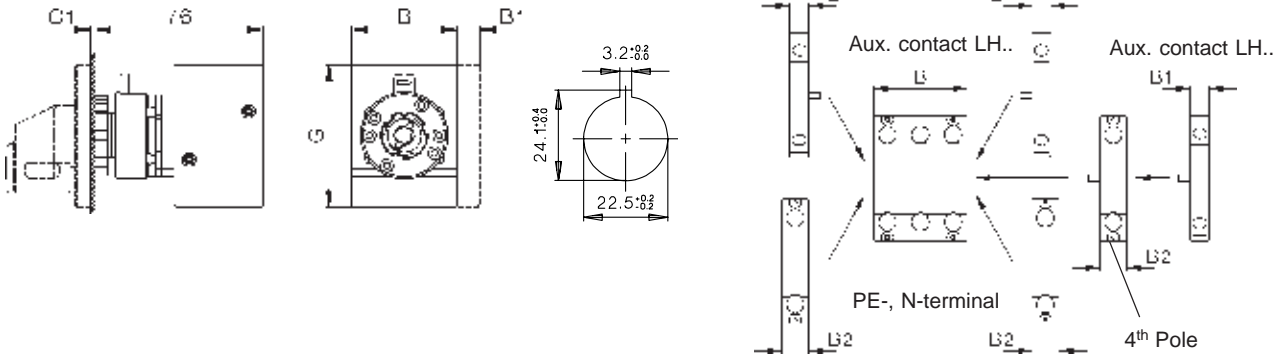

Type	Changeover ON-OFF Escutch. plate or padlock device	3-pole		4-pole		aux. contact B1	4 Pole				3,4-pole					
		A	B	B	B		B	PE B2	C1	D1	D2	E	F	G	H	H
LTS..	48 □, SV1	48	48	62,5	-	-	10	14,5	1-5	10	5	36	-	64	54	-
LTS..	64 □, SV4, SV164	64	48	62,5	97	126	10	14,5	1-5	10	5	48	-	64	54	74
LTS85-125..	64 □, SV4	64	78	78	-	-	10	-	1-5	10	5	48	-	85	60	-
LT125/160	88 □, SV34	88	112	150	224	-	-	-	1-4	13-17	6	68	49,3	108	96	98

**Escutcheon plate**  
48 □

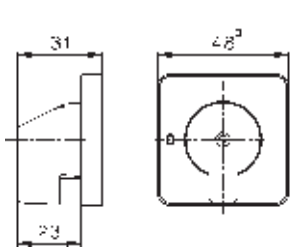

64 □

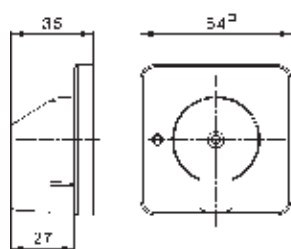

**Padlock devices**  
SV1

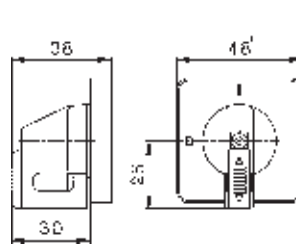

SV164

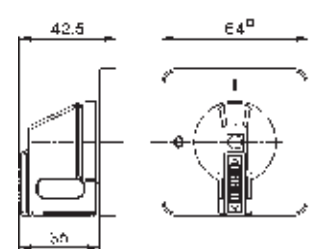

**Padlock devices**  
SV4

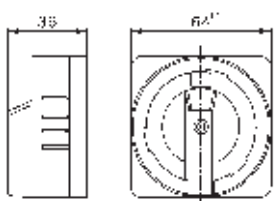

SV488

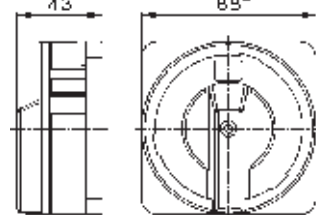

SV34

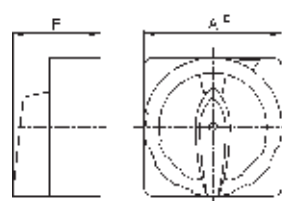

# Dimensions (mm)

## Main Switches, Switch Disconnectors LT(S)..

**Base mounting LTS.. VZV(HN)..**  
ON-OFF Switches 3-pole, 4-pole

$L = X - 40 \pm 3$

6-pole  
for LTS20 - 40 only  
 $L = X - 40 \pm 3$

ON-OFF Switches 6-pole, 8-pole  
Changeover Switches 3-pole, 4-pole  
 $L = X - 60 \pm 3$

Mounting holes

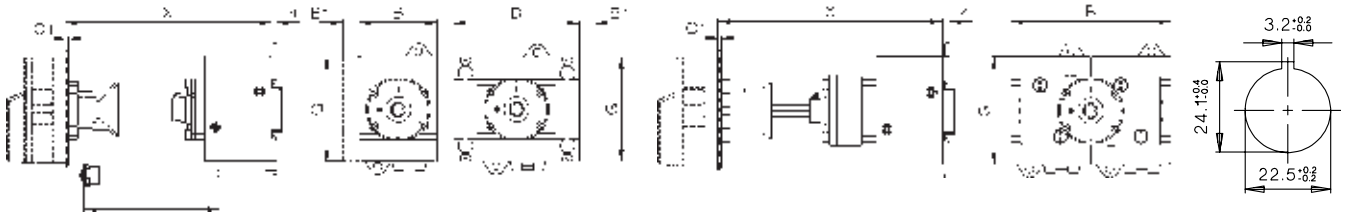

**Base mounting LT(S).. V(HN)..**  
ON-OFF Switches 3-pole, 4-pole

$L = T - 60 \pm 3$  for LTS20 - 80 only

6-pole  
for LTS20 - 40 only  
 $L = X - 60 \pm 3$

ON-OFF Switches 6-pole, 8-pole  
Changeover Switches 3-pole, 4-pole  
 $L = T - 80 \pm 3$  for LTS20 - 80 only

Mounting holes

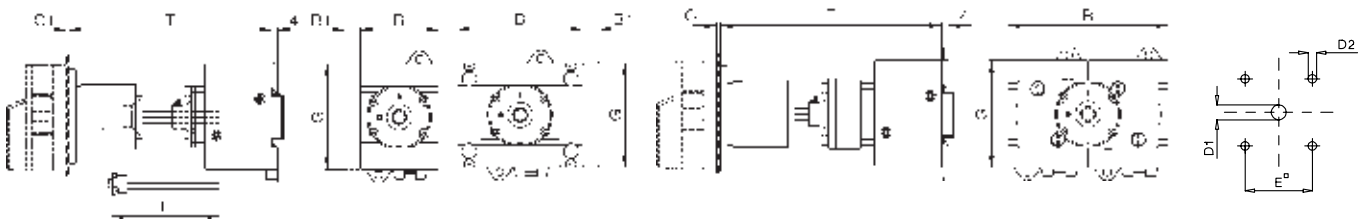

**Base mounting LTS.. VZ(HN)..**  
ON-OFF Switches 3-pole, 4-pole

6-pole  
for LTS20 - 40 only

ON-OFF Switches 6-pole, 8-pole  
Changeover Switches 3-pole, 4-pole

Mounting holes

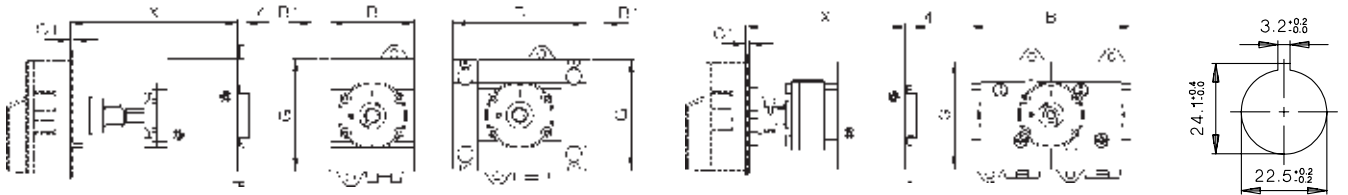

Type	Changeover ON-OFF Escutch. plate or padlock device	3-pole		4-pole	6-pole	3,4-pole 8-pole	aux. contact B1	4.Pole PE B2	C1	D1	D2	D3	E	G	K	K1	J
		A	B	B	B	B											
LTS20 -40	64 □, SV4, SV164	64	48	48	77	97	10	14,5	1-5	10	5	M4	48	64	25	48	70
LTS63, 80	64 □, SV4, SV164	64	48	62,5	97	126	10	14,5	1-5	10	5	M4	48	64	25	48	70
LTS85-125..	64 □, SV4	64	78	78	-	-	10	-	1-5	10	5	M4	48	85	38	-	90
LT125/160	88 □, SV34	88	112	150	224	-	-	-	1-4	13/27 <sup>2)</sup>	6	M6	68	108	36	-	120

**Base mounting**  
ON-OFF Switches LTS20 - LTS80

3-pole, 4-pole  
6-pole LTS20 -40

6-pole, 8-pole  
Changeover Switches

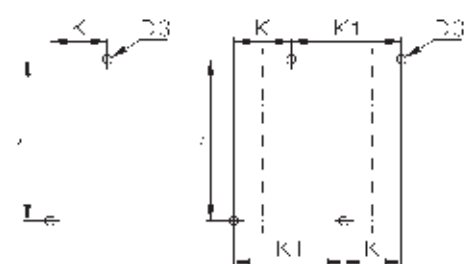

**LTS85-125, LT160**  
3-pole, 4-pole

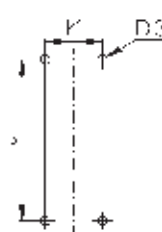

### Mounting of Accessories LTS20 - LTS80

Base mounting, for distribution boards

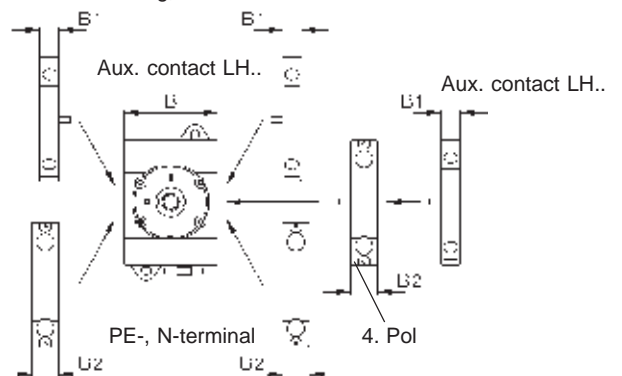

1) Ø 22-25 for LT80(100) VH(N)34 .. only  
2) Ø 26-30 for LT125(160) VH(N)34 .. only

## Dimensions (mm)

### Main Switches, Switch Disconnectors LT(S)..

#### Installation cover LT(S).. SMA(HN)..

ON-OFF Switches 3-pole, 4-pole

ON-OFF Switches 6-pole  
for LTS20 - 40 only

ON-OFF Switches 6-pole, 8-pole  
Changeover Switches 3-pole, 4-pole

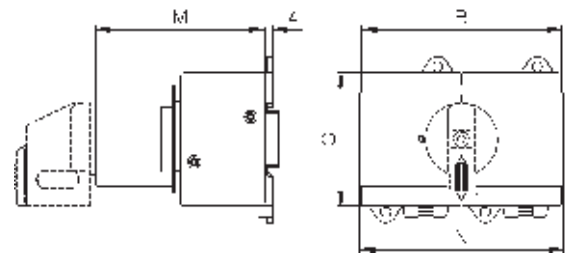
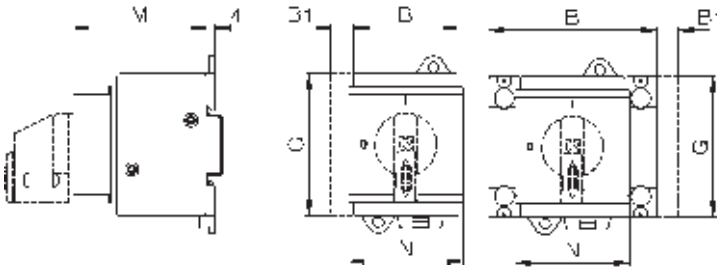

Type	Changeover ON-OFF padlock device	3,4-pole						G	3,4-pole			3,4-pole		
		3-pole	4-pole	6-pole	8-pole	aux. contact	4.pole PE		3-pole 4-pole	6-pole	8-pole	3-pole 4-pole	6-pole	8-pole
		B	B	B	B	B1	B2		M	M	M	N	N	N
<b>LTS20 - 40</b>	SV1, SV164	48	48	77	96	10	14,5	64	60	60	74	52	52	97 <sup>1)</sup>
<b>LTS63, 80</b>	SV1, SV164	48	62,5	96	125	10	14,5	64	60	74	74	52	97 <sup>1)</sup>	126
<b>LT80..</b>	SV1	70	92	140	-	11	-	80	70	70	70	70	70	-
<b>LT100..</b>	SV1	70	92	140	-	11	-	80	70	70	70	70	70	-

1) inclusiv removable cover parts 126mm

### Maintenance and Safety Switches LT(S)..PF..

Type	Pole	A	B	D1	D2	E	F	H
<b>LTS20 PFH.. A., LTS40 PFH.. A</b>	3, 4	130	98	2x25,5/20,5	-	75	100	77
<b>LTS63 PFH.. - LTS125 PFH.. A.</b>	3, 4	200	120	40,5/32,5 +16,5	-	95	165	86
<b>LTS20 PFH.. A., LTS40 PFH.. A</b>	6	200	120	40,5/32,5 +16,5	-	95	165	86
<b>LTS20 PFH.. A., LTS40 PFH.. A</b>	8	240	160	40,5/32,5	-	130	228	120
<b>LTS63 PFH.. A., LTS80 PFH.. A.</b>	6, 8	240	160	40,5/32,5	-	130	228	120
<b>LT125 PFH., LT160 PF..</b>	3	300	200	2x50,5	25,5	172	272	172
<b>LT125 PFH., LT160 PF..</b>	4	300	280	2x50,5	-	254	254	180

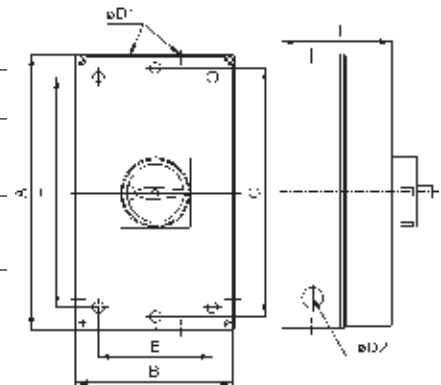

### Switch Disconnectors in Plastic Enclosure LTS..PF..

Type	Pole	A	B	D1	E	F	H
<b>LTS20 PF A., LTS40 PF A</b>	3, 4	130	98	2x25,5/20,5	75	100	77
<b>LTS63 PF A., LTS80 PF A.</b>	3, 4	200	120	40,5/32,5 +16,5	95	165	86

